

**MS2690A/MS2691A/MS2692A
Signal Analyzer
Operation Manual
Spectrum Analyzer Function
Operation**

40th Edition

- For safety and warning information, please read this manual before attempting to use the equipment.
- Additional safety and warning information is provided within the MS2690A/MS2691A/MS2692A Signal Analyzer Operation Manual (Mainframe Operation). Please also refer to this document before using the equipment.
- Keep this manual with the equipment.

ANRITSU CORPORATION

Safety Symbols

To prevent the risk of personal injury or loss related to equipment malfunction, Anritsu Corporation uses the following safety symbols to indicate safety-related information. Ensure that you clearly understand the meanings of the symbols BEFORE using the equipment. Some or all of the following symbols may be used on all Anritsu equipment. In addition, there may be other labels attached to products that are not shown in the diagrams in this manual.

Symbols used in manual



DANGER

This indicates a very dangerous procedure that could result in serious injury or death if not performed properly.



WARNING

This indicates a hazardous procedure that could result in serious injury or death if not performed properly.



CAUTION

This indicates a hazardous procedure or danger that could result in light-to-severe injury, or loss related to equipment malfunction, if proper precautions are not taken.

Safety Symbols Used on Equipment and in Manual

The following safety symbols are used inside or on the equipment near operation locations to provide information about safety items and operation precautions. Ensure that you clearly understand the meanings of the symbols and take the necessary precautions BEFORE using the equipment.



This indicates a prohibited operation. The prohibited operation is indicated symbolically in or near the barred circle.



This indicates an obligatory safety precaution. The obligatory operation is indicated symbolically in or near the circle.



This indicates a warning or caution. The contents are indicated symbolically in or near the triangle.



This indicates a note. The contents are described in the box.



These indicate that the marked part should be recycled.

MS2690A/MS2691A/MS2692A

Signal Analyzer

Operation Manual Spectrum Analyzer Function Operation

24 April 2007 (First Edition)

23 June 2016 (40th Edition)

Copyright © 2007-2016, ANRITSU CORPORATION.

All rights reserved. No part of this manual may be reproduced without the prior written permission of the publisher.

The contents of this manual may be changed without prior notice.

Printed in Japan

Notes On Export Management

This product and its manuals may require an Export License/Approval by the Government of the product's country of origin for re-export from your country.

Before re-exporting the product or manuals, please contact us to confirm whether they are export-controlled items or not.

When you dispose of export-controlled items, the products/manuals need to be broken/shredded so as not to be unlawfully used for military purpose.

Cautions against computer virus infection

- Copying files and data
Only files that have been provided directly from Anritsu or generated using Anritsu equipment should be copied to the instrument.
All other required files should be transferred by means of USB or CompactFlash media after undergoing a thorough virus check.
- Adding software
Do not download or install software that has not been specifically recommended or licensed by Anritsu.
- Network connections
Ensure that the network has sufficient anti-virus security protection in place.

About This Manual

■ Operation manual configuration

The operation manual configuration of the MS2690A/MS2691A/MS2692A Signal Analyzer is shown below.

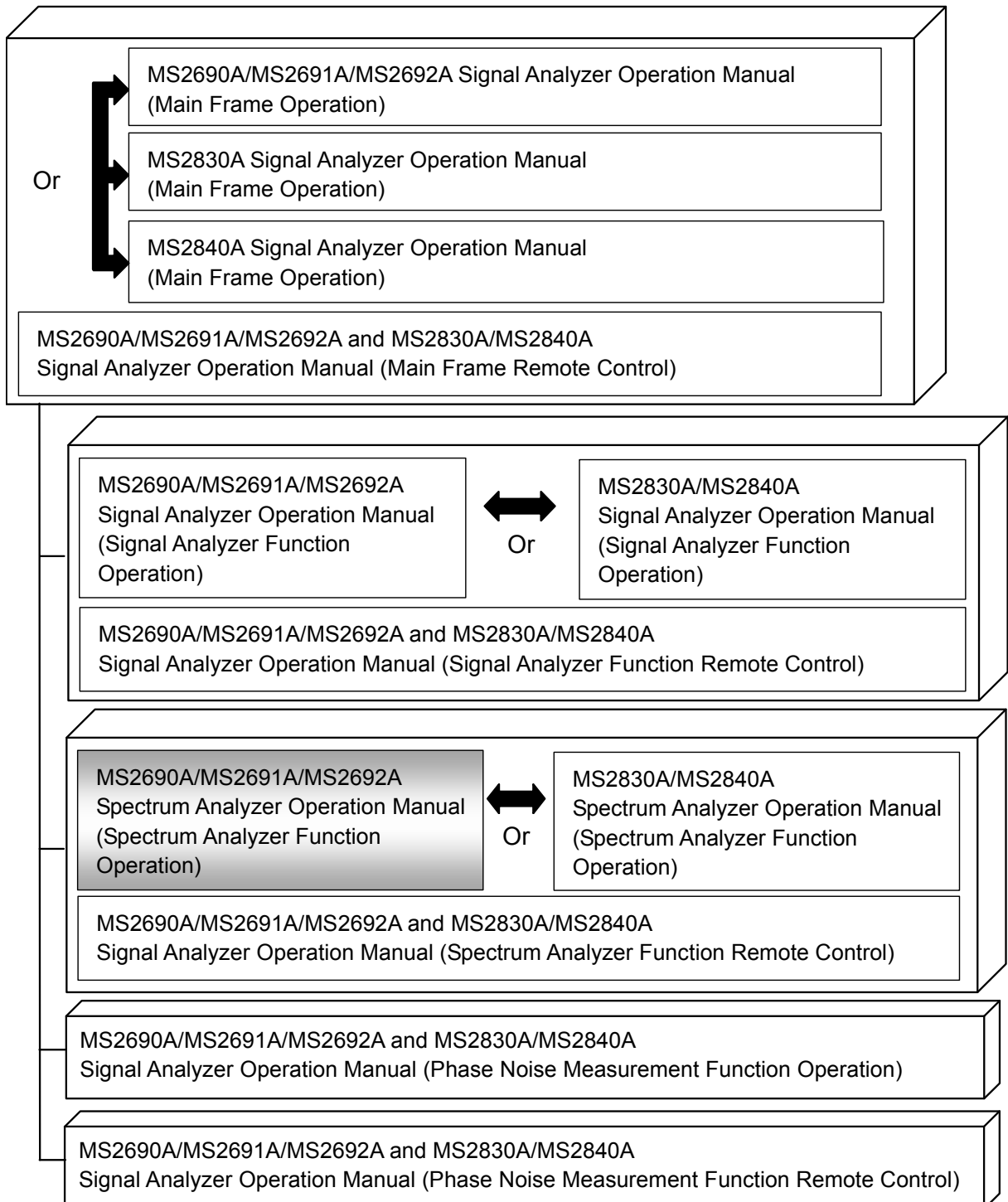

- Signal Analyzer Operation Manual (Mainframe)
- Signal Analyzer Operation Manual (Mainframe Remote Control)
Description of basic operations, maintenance procedures, common functions and common remote functions of the mainframe
- Signal Analyzer Operation Manual (Signal Analyzer Function)
- Signal Analyzer Operation Manual (Signal Analyzer Function Remote Control)
Description of basic operations, functions and remote functions of the signal analyzer
- Signal Analyzer Operation Manual (Spectrum Analyzer Function) <This document>
- Signal Analyzer Operation Manual (Spectrum Analyzer Function Remote Control)
Description of basic operations, functions and remote functions of the spectrum analyzer
- Signal Analyzer Operation Manual (Phase Noise Measurement Function Operation)
- Signal Analyzer Operation Manual (Phase Noise Measurement Function Remote Control)
Description of basic operations, functions and remote functions of the phase noise measurement function.

In this document,  indicates a panel key.

- Signal Analyzer Operation Manual (Spectrum Analyzer Function Remote Control)
Description of basic operations, functions and remote functions of the spectrum analyzer
- Signal Analyzer Operation Manual (Phase Noise Measurement Function Operation)
- Signal Analyzer Operation Manual (Phase Noise Measurement Function Remote Control)
Description of basic operations, functions and remote functions of the phase noise measurement function.

In this document,  indicates a panel key.

Table of Contents

About This Manual.....	I
Chapter 1 Overview.....	1-1
1.1 Overview of Spectrum Analyzer	1-2
1.2 Features of Spectrum Analyzer	1-3
Chapter 2 Basic Operation.....	2-1
2.1 Display Description	2-2
2.2 Single/Continuous Sweep.....	2-4
2.3 Setting Frequency.....	2-5
2.4 Setting Level	2-14
2.5 Setting RBW/VBW	2-29
Chapter 3 Display Mode Selection	3-1
3.1 Setting Storage Mode	3-2
3.2 Setting Limit Line	3-10
3.2 Setting Time/Sweep.....	3-29
3.4 Save on Event.....	3-33
Chapter 4 Marker Function	4-1
4.1 Setting Marker.....	4-2
4.2 Setting Peak Search Function	4-13
4.3 Displaying Marker List	4-23
Chapter 5 Trigger Function and Gate Function	5-1
5.1 Setting Trigger Function	5-2
5.2 Setting Gate Function	5-7
Chapter 6 Preselector Tuning Function...	6-1
6.1 Preselector Tuning Function.....	6-2

Chapter 7 Measure Function	7-1
7.1 Selecting Measure Function	7-2
7.2 Adjacent Channel Leakage Power Measurement (ACP)	7-4
7.3 Burst Average Power Measurement.....	7-12
7.4 Channel Power Measurement (Channel Power)	7-15
7.5 Occupied Bandwidth Measurement (Occupied Bandwidth)	7-17
7.6 Spectrum Emission Mask Measurement (Spectrum Emission Mask).....	7-20
7.7 Spurious Emission Measurement.....	7-31
7.8 Two-tone Third Order Intermodulation Distortion	7-48
Chapter 8 Other Functions	8-1
8.1 Selecting Other Function	8-2
8.2 Setting Title	8-3
8.3 Deleting Warmup Message	8-4
8.4 Setting Uncal Message	8-5
8.5 Adjusting Internal Reference Frequency Signal	8-5
8.6 Input Source for Reference Frequency Signal	8-7
Appendix A Error Messages	A-1
Appendix B Default Value List.....	B-1
Appendix C Standard Parameter List.....	C-1
Index	Index-1

1
2
3
4
5
6
7
8
Appendix
Index

Chapter 1 Overview

This chapter provides an overview of the Spectrum Analyzer function.

1.1	Overview of Spectrum Analyzer	1-2
1.2	Features of Spectrum Analyzer	1-3

1.1 Overview of Spectrum Analyzer

The MS2690A/MS2691A/MS2692A Signal Analyzer (hereinafter, referred to as “MS2690A/MS2691A/MS2692A”) is a device used for the quick, highly accurate, and simple measurement of the transmission characteristics of various wireless devices and systems.

The spectrum analyzer function enables full-span analysis of a broad spectrum, which is a characteristic of conventional sweep type spectrum analyzers, and realizes quick and highly accurate signal processing through the use of a digital IF block. These features make the Spectrum Analyzer function ideal for various applications ranging from R&D to manufacturing.

The Spectrum Analyzer function has the following features.

- Frequency band (6 GHz/13.5 GHz/26.5 GHz)
- Broad analysis bandwidth (20 MHz)
- High dynamic range (180 dB)
- High-speed and high-accuracy signal analysis through digital IF

1.2 Features of Spectrum Analyzer

A spectrum analyzer is a measuring device for analyzing the frequency components of an input signal. The relative values of the various frequency components are displayed in graph form, with the horizontal axis representing the frequency and the vertical axis the signal level.

Figure 1.2-1 shows a schematic representation of a signal that includes a harmonic distortion component as observed with an oscilloscope and a spectrum analyzer. Observation of a signal that includes harmonic components with an oscilloscope yields a waveform with distortion, not a sine wave. This indicates that the signal includes harmonic components, but the magnitudes of the various harmonic components cannot be quantitatively measured. Using a spectrum analyzer enables the quantitative grasp of signal components by dividing the signal components into their various frequency components and graphing each frequency and amplitude. In the example shown in Figure 1.2-1, the signal can be seen to consist of a fundamental wave (f_0) and a second harmonic component ($2 \times f_0$), and their respective amplitudes can be read from this figure.

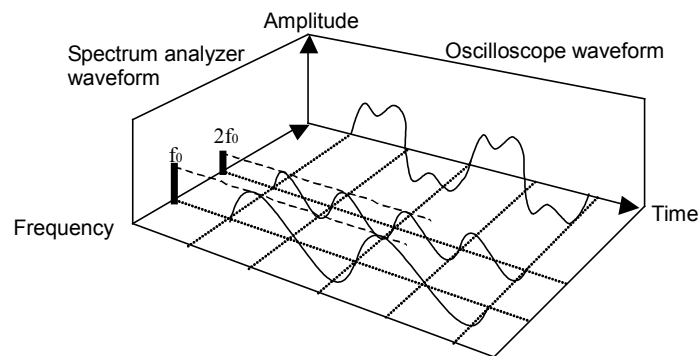

Figure 1.2-1 Comparison of spectrum analyzer and oscilloscope

Spectrum analyzer principle

A spectrum analyzer separates the input signal down to the level of single frequencies and obtains their respective amplitudes. Concretely, following extraction of single frequencies using a narrow-band filter(s), their amplitudes are obtained through wave detection. Separation into the various signal components through the use of a filter(s) can be done using two different methods. One method consists in using multiple filters to obtain the various frequency components in one time (real-time method), while the other method consists in obtaining the various frequency components by changing the center frequency of a single filter over time (sweep method).

The real-time method, which is characterized by a small time lag, is suitable for measurement in a narrow frequency range of several tens of MHz maximum. Compared to the real-time method, the sweep method requires a long time to draw a screen, but since it allows observation of a wide frequency range on the order of several GHz at one time, it is a powerful method for high-order harmonic level measurement and the detection of unknown frequency components.

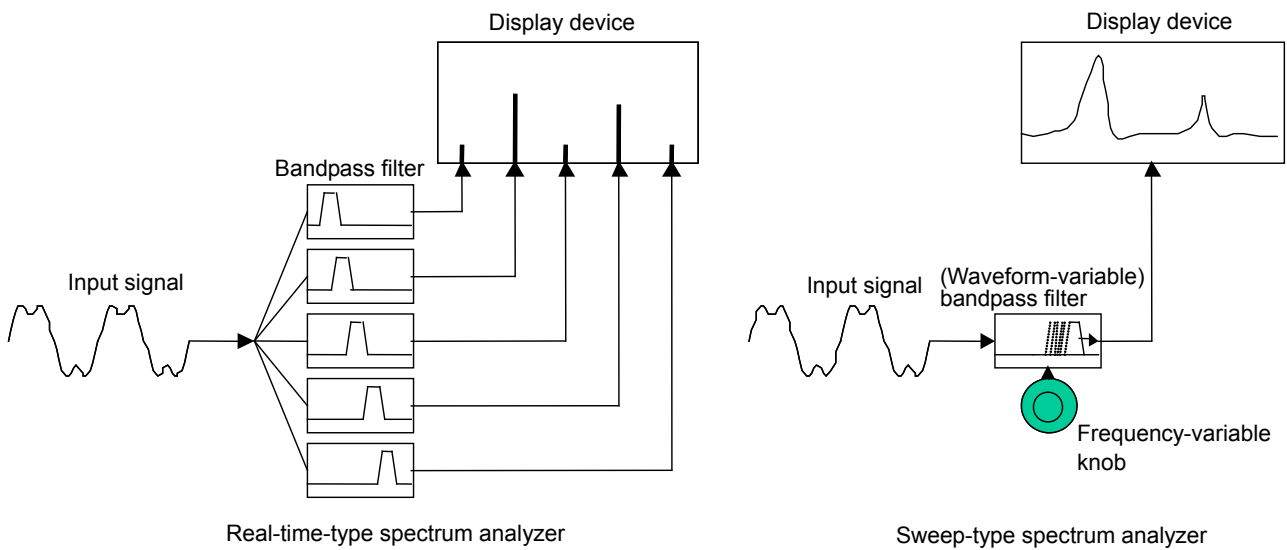

Figure 1.2-2 Spectrum analyzer principle

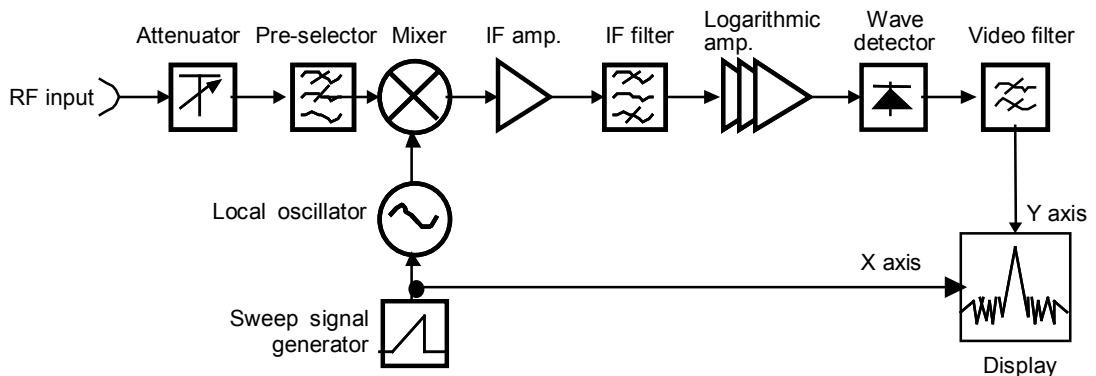

Figure 1.2-3 Configuration of typical sweep-type spectrum analyzer

Figure 1.2-3 shows the configuration of a typical sweep-type spectrum analyzer. The super heterodyne method, which is one of the methods that can be used for implementing a sweep-type spectrum analyzer, is described below. The input signal from external sources passes through an input circuit consisting of an attenuator and a preselector and is mixed with the signal from the local oscillator by a mixer. Here, the input signal is converted into a signal of a given frequency (IF). After being processed through an IF stage, this IF signal determines the vertical axis (level) on the display based on its level. The local oscillator, which operates on the principle that the oscillation voltage changes according to the input voltage, is controlled by the signal from the sweep signal generator (sawtooth wave generator) and determines the horizontal axis (frequency) of the display. As a result, a level that corresponds to the input frequency is displayed as a graph.

The input circuit consists of an attenuator for input signal level adjustment, and a pre-selector that prevents erroneous measurement by reducing responses other than that of the reception signal. The IF stage consists of an IF filter used to separate only the target frequency, an IF amplifier with a gain stabilized across a wide level range, and a logarithmic amplifier with excellent linearity. The MS2690A/MS2691A/MS2692A employs a digital IF method in its IF stage to obtain superior linearity and selectivity.

Chapter 2 Basic Operation

This chapter describes the basic operation of the Spectrum Analyzer function.

2.1	Display Description	2-2
2.2	Single/Continuous Sweep.....	2-4
2.3	Setting Frequency.....	2-5
2.3.1	Setting center frequency	2-9
2.3.2	Setting frequency span.....	2-10
2.3.3	Setting start frequency.....	2-11
2.3.4	Setting stop frequency.....	2-11
2.3.5	Setting frequency offset.....	2-12
2.3.6	Changing frequency band	2-12
2.3.7	Setting Whether To Couple Time Domain Parameters and Frequency Domain Parameters	2-13
2.3.8	Setting step size	2-13
2.4	Setting Level	2-14
2.4.1	Setting reference level.....	2-19
2.4.2	Setting input attenuator	2-20
2.4.3	Setting scale	2-23
2.4.4	Setting reference level unit.....	2-25
2.4.5	Setting reference level offset.....	2-26
2.4.6	Pre-amp.....	2-27
2.4.7	Setting impedance.....	2-27
2.4.8	Microwave Preselector Bypass	2-28
2.5	Setting RBW/VBW	2-29
2.5.1	Setting resolution bandwidth (RBW)	2-31
2.5.2	Setting video bandwidth (VBW).....	2-32
2.5.3	Setting Video VBW/Power VBW	2-33

2.1 Display Description

This section describes the main screen and main function menus of the Spectrum Analyzer function.

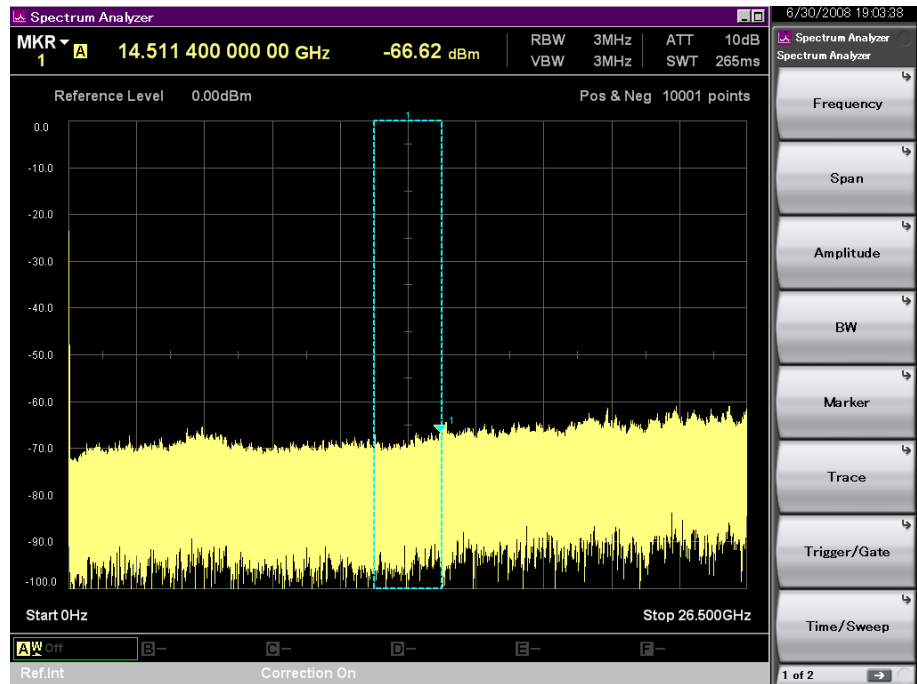



Figure 2.1-1 Main screen of Spectrum Analyzer function

Pressing the  when the Spectrum Analyzer function is selected in the Application Switch menu displays the main function menu.















The main function menu consists of two pages, which can be toggled by pressing .

Table 2.1-1 Main function menu

Function Key	Menu Display	Function
Page1	Spectrum Analyzer	Press Spectrum Analyzer to display this page.
F1	Frequency	Executes frequency setting and preselector auto tuning.  2.3 "Setting Frequency"
F2	Span	Sets the frequency span and frequency band.  2.3 "Setting Frequency"
F3	Amplitude	Sets the level.  2.4 "Setting Level"
F4	BW	Sets the resolution bandwidth and video bandwidth.  2.5 "Setting RBW/VBW"
F5	Marker	Sets markers.  4.1 "Setting Marker"
F6	Trace	Sets the trace.  3.1 "Setting Storage Mode"
F7	Trigger/Gate	Sets the trigger and gate.  Chapter 5 "Trigger Function and Gate Function"
F8	Time/Sweep	Sets the sweep time and trace points.  3.2 "Setting Time/Sweep"
Page2	Spectrum Analyzer	Press Spectrum Analyzer and then press to  display page 2.
F1	Peak Search	Sets the peak search execution and conditions.  4.2 "Setting Peak Search Function"
F2	Measure	Configures settings related to the Measure function.  Chapter 7 "Measure Function"
F7	Save on Event	Sets the Save on Event function that saves Trace data upon occurrence of an event.  3.4 "Save on Event"
F8	Accessory	Sets the other functions.  Chapter 8 "Other Functions"

2.2 Single/Continuous Sweep

There are two types of sweep, single and continuous.

(1) Single sweep

Press  to execute sweep once. When the trigger function or gate function is on, only 1 sweep is executed when the sweep start conditions are met.

(2) Continuous sweep

Press  to execute continuous sweep. When the trigger function or gate function is on, sweep is executed every time the sweep start conditions are met.



Figure 2.2-1 Single key and Continuous key

2.3 Setting Frequency

The Spectrum Analyzer function can set the following four measurement frequencies.

- Center frequency
- Frequency span
- Start frequency
- Stop frequency

Pressing **F1** (Frequency) on page 1 of the main function menu, or pressing **Frequency** displays the Frequency function menu.

Pressing **F2** (Span) on page 1 of the main function menu, or pressing **Span** displays the Span function menu.









Figure 2.3-1 Frequency key and Span key

Frequency function menu



Figure 2.3-2 Frequency function menu

Table 2.3-1 Frequency function menu





Menu Display	Function
Center	Sets the center frequency.  2.3.1 "Setting center frequency"
Start	Sets the start frequency.  2.3.3 "Setting start frequency"
Stop	Sets the stop frequency.  2.3.4 "Setting stop frequency"
Preselector Auto Tune	Automatically adjusts the value of the peaking bias of the preselector.  6.1 "Preselector Tuning Function"
Offset (On/Off)	Switches on/off the frequency offset function.  2.3.5 "Setting frequency offset"
Offset Value	Sets the frequency offset value.  2.3.5 "Setting frequency offset"
Step Size	Sets the step size of the center/start/stop frequencies.  2.3.9 "Setting step size"

Span function menu



Figure 2.3-3 Span function menu

Table 2.3-2 Span function menu

Menu Display	Function
Span	Sets the frequency span.  2.3.2 "Setting frequency span"
Full Span	Sets full span.  2.3.2 "Setting frequency span"
Zero Span	Sets zero span.  2.3.2 "Setting frequency span"
Couple Time/Frequency Domain	Sets whether to couple the time domain parameters and frequency domain parameters.  2.3.7 "Setting Whether To Couple Time Domain Parameters and Frequency Domain Parameters"
Frequency Band Mode	Sets the frequency band mode.  2.3.6 "Changing frequency band"

The display items related to the frequency parameters are described below.

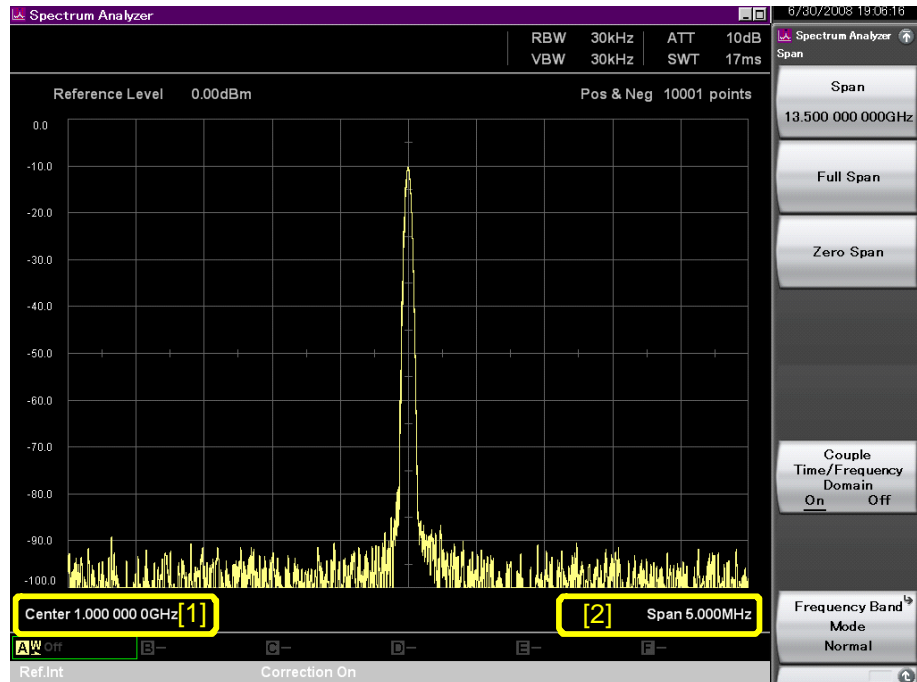

Figure 2.3-4 Display items related to frequency parameters

Table 2.3-3 Display items related to frequency parameters

No.	Display	Description
[1]	Center or Start	Displays the center frequency or start frequency.
[2]	Span or Stop	Displays the frequency span or stop frequency.

2.3.1 Setting center frequency

The center frequency of the frequency range to be swept can be set.

Setting range and resolution for center frequency

Setting range: –100 MHz to 6.05 GHz (MS2690A)*
 –100 MHz to 13.6 GHz (MS2691A)*
 –100 MHz to 26.6 GHz (MS2692A)*

*: The setting range is limited by the other frequency settings.

Resolution: 1 Hz

Example: To set the center frequency to 1 MHz

<Procedure>

1. Press .
2. After pressing , press  (MHz) to set the center frequency.

2.3.2 Setting frequency span

The frequency span to be swept can be set. The mode when the frequency span is 0 Hz higher than is called the frequency domain mode (horizontal axis = frequency), and if it is 0 Hz, it is called the time domain mode (horizontal axis = time).

Setting range and resolution for frequency span





Setting range: 300 Hz to 6.15 GHz (MS2690A)*
 300 Hz to 13.7 GHz (MS2691A)*
 300 Hz to 26.7 GHz (MS2692A)*
 0 Hz (time domain mode)

*: The setting range is limited by the other frequency settings.

Resolution: 2 Hz



Example: To set the frequency span to 100 MHz

<Procedure>

1. Press .
2. After pressing   , press  (MHz) to set the frequency span.



Example: To set the frequency span to its maximum value

<Procedure>



1. Press .
2. Press  (Full Span).

Example: To set the frequency span to 0 Hz (time domain mode)

<Procedure 1>

1. Press .
2. Press  (Zero Span).

<Procedure 2>

1. Press .
2. After pressing , press  (MHz) and set the frequency span to 0 Hz.

2.3.3 Setting start frequency

The start frequency of the frequency range to be swept can be set.

Setting range and resolution for start frequency

Setting range: –100 MHz to 6.0499997 GHz (MS2690A)*
 –100 MHz to 13.5999997 GHz (MS2691A)*
 –100 MHz to 26.5999997 GHz (MS2692A)*

*: The setting range is limited by the other frequency settings.

Resolution: 2 Hz

Example: To set the start frequency to 10 MHz

<Procedure>

1. Press .
2. Press  (Start).
3. After pressing  , press  (MHz) to set the start frequency.

2.3.4 Setting stop frequency

The stop frequency of the frequency range to be swept can be set.

Setting range and resolution for stop frequency

Setting range: –99.9997 MHz to 6.05 GHz (MS2690A)*
 –99.9997 MHz to 13.6 GHz (MS2691A)*
 –99.9997 MHz to 26.6 GHz (MS2692A)*

*: The setting range is limited by the other frequency settings.

Resolution: 2 Hz

Example: To set the stop frequency to 1 GHz

<Procedure>

1. Press .
2. Press  (Stop).
3. After pressing , press  (GHz) to set the stop frequency.

2.3.5 Setting frequency offset

The offset value for the frequency display can be set.

Setting range and resolution for frequency offset

Setting range: -100 to 100 GHz

Resolution: 1 Hz

Example: To set the frequency offset to 1 GHz

<Procedure>

1. Press **Frequency**.
2. Press **F7** (Offset Value).
3. After pressing **1**, press **F1** (GHz) and set the frequency offset.

2.3.6 Changing frequency band

Note:

This function can be set only when Option 003 Extension of Preselector Lower Limit to 3 GHz is installed.

The passing lower limit frequency of the preselector can be changed from 6 GHz to 3 GHz by changing the frequency band mode.

Table 2.3.6-1 Frequency band

Frequency Band Mode	Preselector Passing Frequency
Normal	> 6.0 GHz
Spurious	≥ 3.0 GHz

Example: To set the passing lower limit frequency of the preselector to 3 GHz

<Procedure>

1. Press **Span**.
2. Press **F8** (Frequency Band Mode).
3. Press **F2** (Spurious) and set the passing lower limit frequency of the preselector to 3 GHz.

2.3.7 Setting Whether To Couple Time Domain Parameters and Frequency Domain Parameters



Sets whether to couple the time domain parameters and frequency domain parameters. If coupling is enabled, the RBW, VBW, detection mode, and trace point are coupled (shared) between the time domain and frequency domain. When coupling is enabled, the currently-selected domain parameter is used as a shared setting.

Table 2.3-7 Couple Time/Frequency Domain

Couple Time/Frequency Domain	Descriptions
On	The RBW, VBW, detection mode, and trace point are coupled (shared) between the time domain and frequency domain.
Off	The RBW, VBW, detection mode, and trace point for the time domain are separate from those for the frequency domain.

Example: To disable coupling.

<Procedure>

1. Press .
2. Press  (Couple Time/Frequency Domain) to set Couple Time/Frequency Domain to Off.

2.3.8 Setting step size

The step size of the center, start and stop frequency can be set.





Setting range and resolution for step size

Setting range: 1 Hz to 6.0 GHz (MS2690A)
 1 Hz to 13.5 GHz (MS2691A)
 1 Hz to 26.5 GHz (MS2692A)

Resolution: 1 Hz

Example: To set step size to 1 MHz

<Procedure>

1. Press .
2. Press  (Step Size).
3. After pressing , press  (MHz) to set step size.

2.4 Setting Level

Pressing **F3** (Amplitude) on the main function menu, or pressing **Amplitude** displays the Amplitude function menu.

The Marker function menu consists of 2 pages that are toggled by pressing **→**.











Figure 2.4-1 Amplitude key



Figure 2.4-2 Amplitude function menu

Table 2.4-1 Amplitude function menu

Menu Display	Function
Reference Level	Sets the reference level.  2.4.1 "Setting reference level"
Attenuator (Auto/Manual)	Selects automatic setting or manual setting of the input attenuator.  2.4.2 "Setting input attenuator"
Attenuator	Sets the input attenuator.  2.4.2 "Setting input attenuator"
Pre-amp	Sets Pre-amp to On/Off.  2.4.6 "Pre-amp"
Log Scale Unit	Sets the level display unit to be used during log scale.  2.4.4 "Setting reference level unit"
Scale	Switches log level display and linear level display.  2.4.3 "Setting scale"
Offset (On/Off)	Switches On/Off the reference level offset function.  2.4.5 "Setting reference level offset"
Offset Value	Sets the reference level offset value.  2.4.5 "Setting reference level offset"
Impedance	Sets 50 Ω/75Ω of impedance.  2.4.7 "Setting impedance"

The display items related to the level parameters are described below.

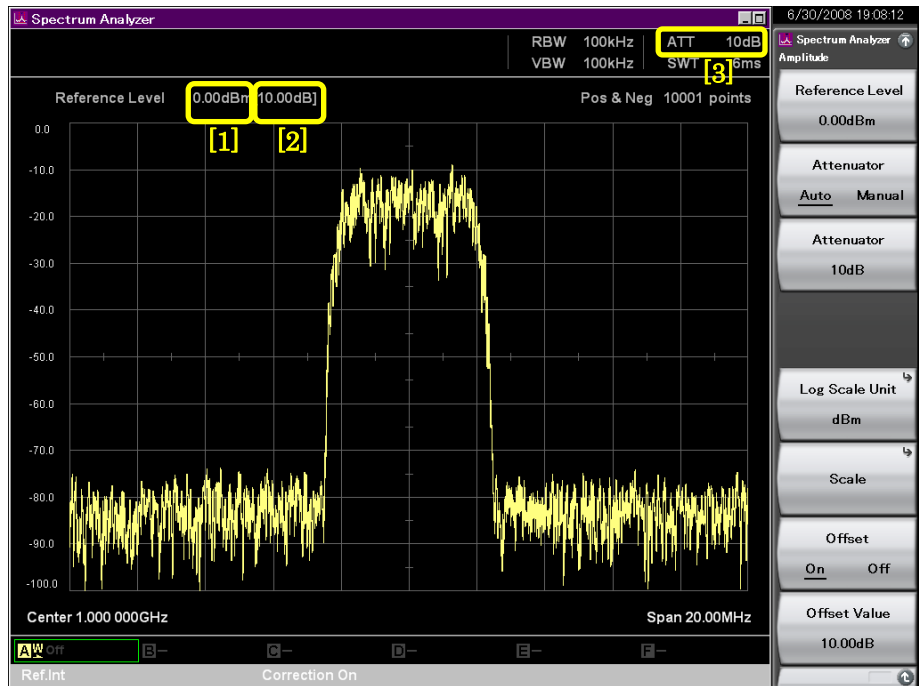

Figure 2.4-3 Display items related to level parameters

Table 2.4-2 Display items related to level parameters

No.	Display	Description
[1]	Reference level	Displays the reference level.
[2]	Reference level offset	Displays the reference level addition offset value.
[3]	Input attenuator	Displays the input attenuator value.

The reference level (upper end of amplitude scale) range is described below.

Setting range and resolution for reference level

Setting range: Refer to Tables 2.4-3 and 2.4-4.

Resolution: 0.01 dB (dB unit system)

Effective number of digits: 3 (W unit)

Effective number of digits: 3 (V unit)

**Table 2.4-3 Reference level setting range
(When Pre-amp is set to Off).**

Scale Mode	Unit	Reference Level Range
Log scale	dBm*1	-120 to +50 dBm
	dB μ V*2	-13.01 to +156.99 dB μ V (Impedance = 50 Ω)
		-11.25 to +158.75 dB μ V (Impedance = 75 Ω)
	dBmV*3	-73.01 to +96.99 dBmV (Impedance = 50 Ω)
		-71.25 to +98.75 dBmV (Impedance = 75 Ω)
	V	0.224 μ V to 70.7 V (Impedance = 50 Ω)
		0.274 μ V to +86.6 V (Impedance = 75 Ω)
W	1 fW to 100 W	
Log scale	dB μ V (emf)*4	-6.99 to +163.01 dB μ V (emf) (Impedance = 50 Ω)
		-5.23 to +164.77 dB μ V (emf) (Impedance = 75 Ω)
	dB μ V/m*5	-13.01 to +156.99 dB μ V/m (Impedance = 50 Ω) -11.25 to +158.75 dB μ V/m (Impedance = 75 Ω)
Linear scale (in dBm)	V	22.4 μ V to 70.7 V (Impedance = 50 Ω) 27.4 μ V to 86.6 V (Impedance = 50 Ω) (-80 to +50 dBm)

Table 2.4-4 Reference level setting range (When Pre-amp is set to On).

Scale Mode	Unit	Reference Level Range
Log scale	dBm*1	-120 to +30 dBm
	dB μ V*2	-13.01 to +136.99 dB μ V (Impedance = 50 Ω) -11.25 to +138.75 dB μ V (Impedance = 75 Ω)
	dBmV*3	-73.01 to +76.99 dBmV (Impedance = 50 Ω) -71.25 to +78.75 dBmV (Impedance = 75 Ω)
	V	0.224 μ V to 7.07 V (Impedance = 50 Ω) 0.274 μ V to 8.66 V (Impedance = 75 Ω)
	W	1 fW to 1 W
	dB μ V (emf)*4	-6.99 to +143.01 dB μ V (emf) (Impedance = 50 Ω) -5.23 to +144.77 dB μ V (emf) (Impedance = 75 Ω)
	dB μ V/m*5	-13.01 to +136.99 dB μ V/m (Impedance = 50 Ω) -11.25 to +138.75 dB μ V/m (Impedance = 75 Ω)
Linear scale (in dBm)	V	2.24 μ V to 7.07 V (Impedance = 50 Ω) 2.74 μ V to 8.66 V (Impedance = 50 Ω) (-100 to +30 dBm)

*1: Unit system where 1 mW is regarded as 0 dBm

*2: Unit system where 1 μ V is regarded as 0 dB μ V. Indicated by termination voltage with 50 Ω terminator.
When impedance is set to 75 Ω , it is displayed as the terminal voltage of 75 Ω .

*3: Unit system where 1 mV is regarded as 0 dBmV. Indicated by termination voltage with 50 Ω terminator.
When impedance is set to 75 Ω , it is displayed as the terminal voltage of 75 Ω .

*4: Unit system in dB μ V, indicated by open voltage. The value is “dB μ V + 6.02 dB”.







*5: Unit system indicating electric field intensity. The displayed value depends on the antenna factor.

2.4.1 Setting reference level

The reference level (upper end of amplitude scale) can be set.

Example: To set the reference level to -10 dBm

<Procedure>

1. Press .
2. Press  (Reference Level).
3. After pressing   , press  (dBm) to set the reference level.

2.4.2 Setting input attenuator

(1) Auto mode

The input attenuator is automatically set according to the set reference level. When a signal of the same level as the reference level is input, the input level to the internal mixer is set so as become -10 dBm or lower.

Tables 2.4.2-1 and 2.4.2-2 show the settings in the Auto mode.

**Table 2.4.2-1 Input attenuators set in Auto mode
(When Pre-amp is set to Off)**

N = Reference Level (dBm)	Attenuator Auto (dB)
-120 ≤ N ≤ 0	10
0 < N ≤ 2	12
2 < N ≤ 4	14
4 < N ≤ 6	16
6 < N ≤ 8	18
8 < N ≤ 10	20
10 < N ≤ 12	22
12 < N ≤ 14	24
14 < N ≤ 16	26
16 < N ≤ 18	28
18 < N ≤ 20	30
20 < N ≤ 22	32
22 < N ≤ 24	34
24 < N ≤ 26	36
26 < N ≤ 28	38
28 < N ≤ 30	40
30 < N ≤ 32	42
32 < N ≤ 34	44
34 < N ≤ 36	46
36 < N ≤ 38	48
38 < N ≤ 40	50
40 < N ≤ 42	52
42 < N ≤ 44	54
44 < N ≤ 46	56
46 < N ≤ 48	58
48 < N ≤ 50	60

**Table 2.4.2-2 Input attenuators set in Auto mode
(When Pre-amp is set to On)**

N = Reference Level (dBm)	Attenuator Auto (dB)
$-120 < N \leq -20$	10
$-20 < N \leq -18$	12
$-18 < N \leq -16$	14
$-16 < N \leq -14$	16
$-14 < N \leq -12$	18
$-12 < N \leq -10$	20
$-10 < N \leq -8$	22
$-8 < N \leq -6$	24
$-6 < N \leq -4$	26
$-4 < N \leq -2$	28
$-2 < N \leq 0$	30
$0 < N \leq 2$	32
$2 < N \leq 4$	34
$4 < N \leq 6$	36
$6 < N \leq 8$	38
$8 < N \leq 10$	40
$10 < N \leq 12$	42
$12 < N \leq 14$	44
$14 < N \leq 16$	46
$16 < N \leq 18$	48
$18 < N \leq 20$	50
$20 < N \leq 22$	52
$22 < N \leq 24$	54
$24 < N \leq 26$	56
$26 < N \leq 28$	58
$28 < N \leq 30$	60

(2) Manual mode

To measure extremely low level signals such as non-harmonic spurious signals or spurious signals adjustment to the signal, set the input attenuator manually.

The setting range of the input attenuator in Manual setting is as follows.

Setting range and resolution for input attenuator

Input attenuator setting range: Refer to Tables 2.4.2-3 and 2.4.2-4.

Input attenuator minimum resolution: 2 dB

**Table 2.4.2-3 Input attenuator setting range
(When Pre-amp is set to Off)**

Attenuator Manual	
Lower limit	Upper limit
Logic* ($\alpha = 0, \beta = 1, \gamma = 2$) The minimum value is 0 dB.	60 dB

**Table 2.4.2-4 Input attenuator setting range
(When Pre-amp is set to On)**

Attenuator Manual	
Lower limit	Upper limit
Logic* ($\alpha = 20, \beta = 21, \gamma = 22$) The minimum value is 0 dB	60 dB

*: The following rules apply:

<1> If the reference level is 0 or if it is divisible by 2.

$$\text{Attenuator (dB)} = \text{RL}^{*1} + \alpha$$

<2> Not <1>, and INT (RL)^{*2} is an odd number.

$$\text{Attenuator (dB)} = \text{INT (RL)}^{*2} + \beta$$

<3> Not <1>, and INT (RL)^{*2} is an even number.

$$\text{Attenuator (dB)} = \text{INT (RL)}^{*2} + \gamma$$

*1: Reference level (dBm)

*2: Maximum integer not exceeding reference level.

Example: To set the input attenuator to 20 dB

<Procedure>

1. Press **Amplitude**.
2. Press **F3** (Attenuator).
3. After pressing **2** **0**, press **F1** (dB) to set the input attenuator.

For measurement of second and third harmonic spurious, the mixer input level must be lowered to eliminate the effect of internal distortion. Internal distortion is below -75 dB (at 1 GHz) when the mixer input level is -30 dBm, so to measure harmonic spurious up to -75 dB, the mixer input level must be below -30 dBm. In this case, if the attenuator setting is Auto, the attenuator value is too small.

2.4.3 Setting scale

Pressing **F6** (Scale) on the Amplitude function menu displays the Scale function menu.

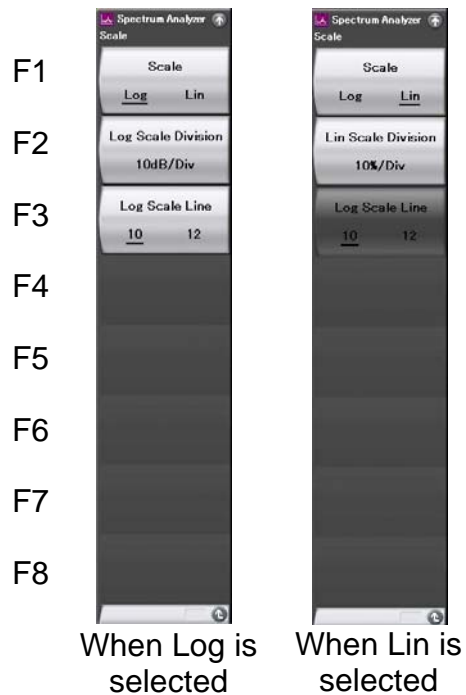

Figure 2.4.3-1 Scale function menu

Table 2.4.3-1 Scale function menu

Menu Display	Function
Scale (Log/Lin)	Selects the scale mode (Log/Lin).
Log Scale Division	Sets the scale range (Log scale range).
Lin Scale Division	Sets the scale range (Lin scale range).
Log Scale Line (10/12)	Selects the number of scale lines during log scale.









(1) Setting the Log scale

The log scale can be selected from the following:

0.1, 0.2, 0.5, 1.0, 2.0, 5.0, 10.0, 20.0 dB/Div

Example: To set Log Scale Division to 20 dB/Div and number of scale lines to 12

<Procedure>

1. Press .
2. Press  (Scale).
3. Press  (Scale) and select Log.
4. Press  (Log Scale Division).
5. After pressing  , press  (dB/Div) to set the Log Scale Division.
6. Press  (Log Scale Line) and set the number of scale lines by selecting 12.







(2) Setting the Lin scale

The Lin scale can be selected from the following:

1, 2, 5, 10%/Div

Example: To set Lin Scale Division to 5%/Div

<Procedure>

1. Press .
2. Press  (Scale).
3. Press  (Scale) and select Lin.
4. Press  (Lin Scale Division).
5. After pressing , press  (%/Div) to set Lin Scale Division.

2.4.4 Setting reference level unit









The level display unit for the Log scale mode can be set. In the case of Lin scale, the level display unit is fixed to V.

Reference level display unit

dBm, dB μ V, dBmV, V, W, dB μ V (emf), dB μ V/m

Example: To set the reference level to 10 dBmV

<Procedure>

1. Press .
2. Press  (Scale).
3. Press  (Scale) and select Log.
4. Press  to return to the previous menu.
5. Press  (Log Scale Unit) and then press  (dBmV).
6. After pressing  , press  (dBmV) to set the reference level unit.

If V (W) is selected and a measurement result is more than 99.999 GV(GW), 99.999 GV(GW) is displayed.

2.4.5 Setting reference level offset

The waveform trace can be displayed with an arbitrary offset value added.

Setting range and resolution for reference level offset

Setting range: -100 to 100 dB

Resolution: 0.01 dB

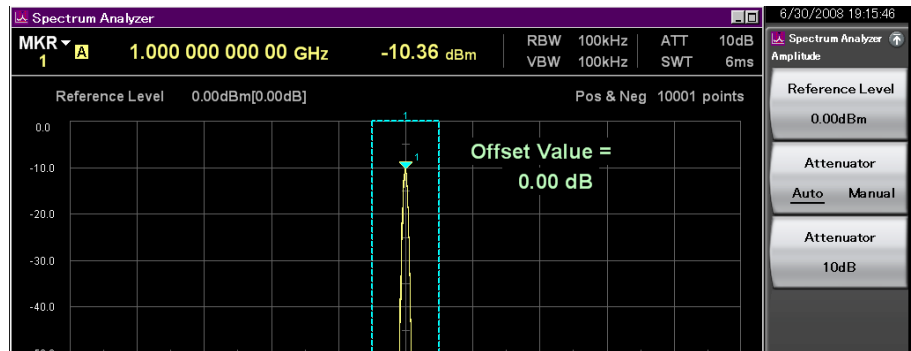

Set offset value to +10 dB

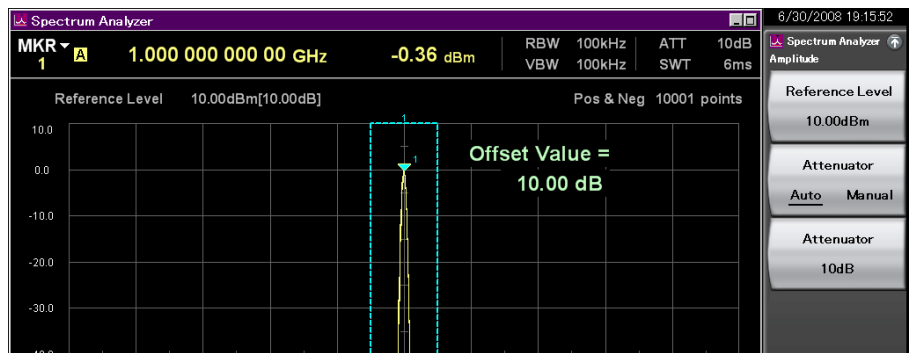

Figure 2.4.5-1 Adding an offset value

Example: To set the reference offset value to 10 dB

<Procedure>

1. Press **Amplitude**.
2. Press **F7** (Offset) and select On.
3. Press **F8** (Offset Value).
4. After pressing **1** **0**, press **F1** (dB) to set the reference level offset value.

2.4.6 Pre-amp



Note:

This function can be set only when Option 008 6GHz Pre-amp is installed.

The level sensitivity can be increased by setting Pre-amp to On.

Example: To set Pre-amp to On

<Procedure>

1. Press .
2. Press  (Pre-Amp) to set to On.

2.4.7 Setting impedance



Sets 50 Ω /75 Ω of input impedance. The default value is 50 Ω .

This setting is effective when the vertical axis is voltage units (dB μ V, dBmV, V, dB μ V (emf), dB μ V/m); it is not effective when the units are power (dBm, W). The actual input impedance of the equipment is 50 Ω . If the impedance is set to 75 Ω , numeric conversion is performed for the 75- Ω termination and it is reflected in the voltage-units display.

When using a 75/50 Ω converter, set the impedance to 75 Ω . The converter loss can be corrected using the Correction function and reference level offset setting.

Example: To set impedance to 75 Ω

<Procedure>

1. Press .
2. Press . After page 2 of the Amplitude function menu is displayed, press  (Impedance) to set to 75 Ω .

2.4.8 Microwave Preselector Bypass



Note:

This function is available when installing Option 067 Microwave Preselector Bypass.

The frequency characteristics can be improved at 6 GHz or more of the preselector band when setting preselector Bypass to On.

Example: To set Preselector Bypass to On

<Procedure>

1. Press .
2. Pressing  displays the page 2 of Frequency or Amplitude function menu.
3. Pressing F8 (Micro Wave Preselector Bypass) sets Preselector Bypass to On.

2.5 Setting RBW/VBW

The resolution bandwidth (RBW) and video bandwidth (VBW) can be selected either automatically or arbitrarily.

Pressing **F4** (BW) on the main function menu, or pressing **BW** displays the BW function menu.



Figure 2.5-1 BW key

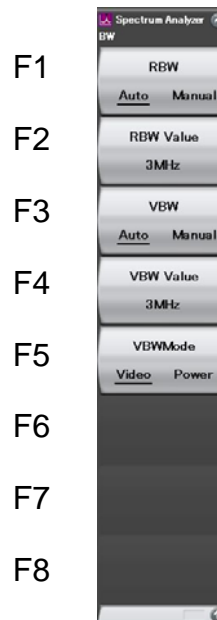







Figure 2.5-2 BW function menu

Table 2.5-1 BW function menu

Menu Display	Function
RBW (Auto/Manual)	Selects automatic or manual setting of the resolution bandwidth (RBW).  2.5.1 "Setting resolution bandwidth (RBW)"
RBW Value	Selects the resolution bandwidth (RBW).  2.5.1 "Setting resolution bandwidth (RBW)"
VBW (Auto/Manual)	Selects automatic or manual setting of the video bandwidth (VBW).  2.5.2 "Setting video bandwidth (VBW)"
VBW Value	Sets the video bandwidth (VBW).  2.5.2 "Setting video bandwidth (VBW)"
VBWMode (Video/Power)	Selects display level smoothing through the video bandwidth (VBW).  2.5.3 "Setting Video VBW/Power VBW"

2.5.1 Setting resolution bandwidth (RBW)

(1) Auto

The resolution bandwidth is automatically set according to the frequency span setting.

(2) Manual

Select an arbitrary resolution bandwidth (RBW). When monitoring two adjacent signals, the frequency resolution can be increased by reducing the resolution bandwidth (RBW). This has also the effect of reducing the noise level.

The resolution bandwidth (RBW) value can be selected from among the following:

30 Hz, 100 Hz, 300 Hz, 1 kHz, 3 kHz, 10 kHz, 30 kHz, 50 kHz, 100 kHz, 300 kHz, 1 MHz, 3 MHz, 5 MHz, 10 MHz, 20 MHz, 31.25 MHz
(31.25 MHz is available only with 0 span.)

Note:

For RBW 31.25 MHz, it is not a Gauss filter but a flat-top characteristic filter. If Couple Time/Frequency Domain is set to Off, this parameter specifies a separate value for frequency-axis measurement and time-axis measurement.

When Couple Time/Frequency Domain is set to Off, each parameter is specified in accordance with the already-specified frequency axis or time axis measurement.

Resolution bandwidth (RBW) setting

Example: To set the resolution bandwidth (RBW) to 10 kHz.

<Procedure>

1. Press **BW**.
2. Press **F2** (RBW Value).
3. After pressing **1** **0**, press **F3** (kHz) and set the resolution bandwidth (RBW).

2.5.2 Setting video bandwidth (VBW)

(1) Auto

The video bandwidth is set to the same as the resolution bandwidth (RBW) or the nearest value. When the detection mode (Detection) is “RMS,” “Auto” is set to off.

(2) Manual

By setting the video bandwidth to a value that is smaller than the resolution bandwidth (RBW), noise averaging is made more efficient. When the detection mode (Detection) is “RMS,” “Manual” is set to off.

The video bandwidth (VBW) value can be selected from the following:





1 Hz, 3 Hz, 10 Hz, 30 Hz, 100 Hz, 300 Hz, 1 kHz, 3 kHz, 5 kHz, 10 kHz, 30 kHz, 100 kHz, 300 kHz, 1 MHz, 3 MHz, 10 MHz, Off

When Couple Time/Frequency Domain is set to Off, each parameter is specified in accordance with the already-specified frequency axis or time axis measurement.

Video bandwidth (VBW) setting

Example: To set the video bandwidth (VBW) to 10 kHz

<Procedure>

1. Press .
2. Press  (VBW Value).
3. After pressing  , press  (kHz) and set VBW.

2.5.3 Setting Video VBW/Power VBW

The Spectrum Analyzer function allows selection of either Video VBW or Power VBW as the video filter for the better and smooth screen display.

Two VBM Modes

Video:

Performs smoothing and averaging with a video filter after logarithmic compression (logarithmic mean).

Power:

Performs smoothing and averaging with a video filter before logarithmic compression (antilog mean). Video VBW indicates similar measurement values as those obtained with a conventional spectrum analyzer, but in the case of signals that fluctuate importantly over time, such as burst waves, a large error margin results. When measuring such signals, select Power for the VBW mode.

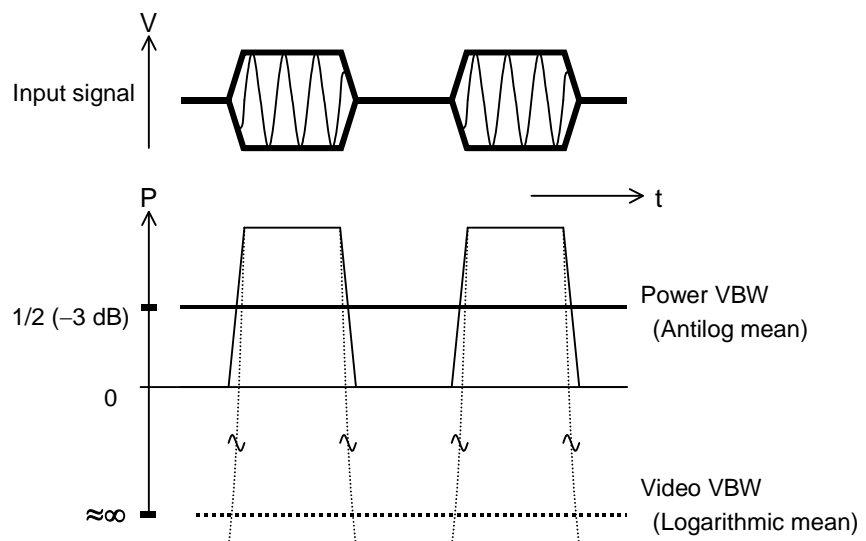

Figure 2.5.3-1 Power VBW and Video VBW

Example: To set VBW Mode to Power

<Procedure>

1. Press **BW**.
2. Press **F5** (VBW Mode) and select Power.

Chapter 3 *Display Mode Selection*

This chapter describes the trace, storage mode, and wave detection mode.

3.1	Setting Storage Mode	3-2
3.1.1	Storage mode types	3-4
3.1.2	Averaging function	3-5
3.1.3	Max Hold/Min Hold function	3-6
3.1.4	Setting wave detection mode	3-7
3.1.5	Displaying and updating Trace	3-9
3.2	Setting Limit Line	3-10
3.2.1	Setting Limit function parameters	3-11
3.2.2	Setting Limits	3-12
3.2.3	Setting Limit1 to 6	3-13
3.2.4	Edit parameters	3-16
3.2.5	Limit Envelope Function	3-21
3.2.6	Saving a Limit file	3-24
3.2.7	Loading a Limit file	3-26
3.3	Setting Time/Sweep	3-29
3.3.1	Setting sweep time	3-31
3.3.2	Setting trace point	3-32
3.4	Save on Event	3-33
3.4.1	Setting Save on Event	3-33
3.4.2	Waveform files for Save on Event	3-35

3.1 Setting Storage Mode

Pressing **F6** (Trace) on the main function menu, or pressing **Trace** displays the Trace function menu.



Figure 3.1-1 Trace key

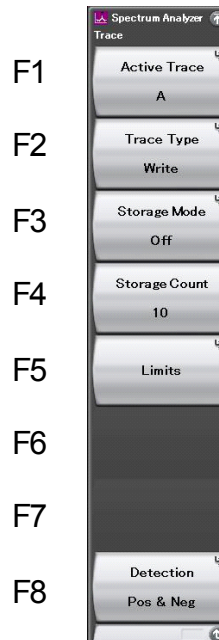







Figure 3.1-2 Trace function menu

Table 3.1-1 Trace function menu

Menu Display	Function
Active Trace	Selects trace to be set. Trace Type and Storage Mode can be set for each trace.
Trace Type	Used for setting related to update and display of trace data.  3.1.5 Displaying/Updating Trace
Storage Mode	Sets the storage mode type.  3.1.1 Storage Mode Types
Storage Count	Sets the storage count.  3.1.2 Averaging Function
Limits	Sets the limit line.  3.2 Setting Limit Line
Detection	Sets the detection mode to Pos&Neg, Positive, Sample, Negative, or RMS.  3.1.4 Setting wave detection mode

3.1.1 Storage mode types

The following storage modes can be selected for trace A, trace B, trace C, trace D, trace E, and trace F.

Table 3.1.1-1 Storage Mode Types

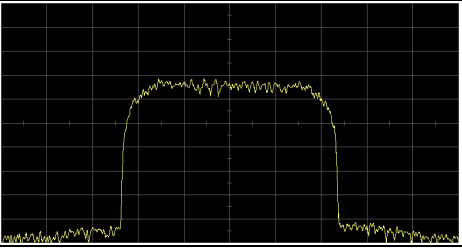
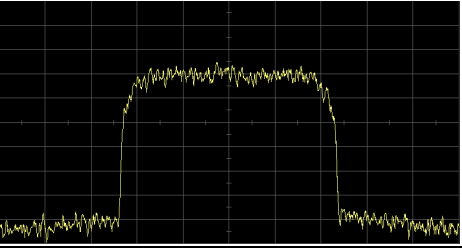
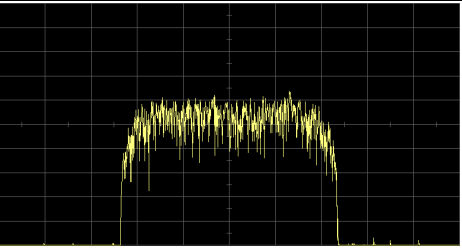
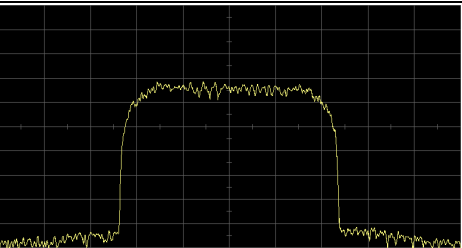
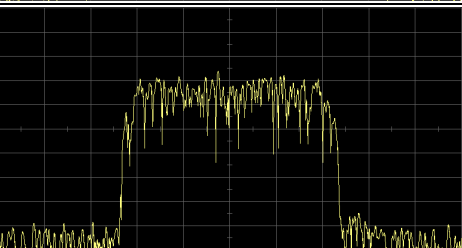
Mode	Display	Description	Display Example
Lin Average	Lin	In the Log display mode, averaging is executed for linear values, and the result is displayed logarithmically.	
Max Hold	Max	At each sweep, the previous and new trace data of each horizontal axis point are compared and the larger of the two is displayed.	
Min Hold	Min	At each sweep, the previous and new trace data of each horizontal axis point are compared and the smaller of the two is displayed.	
Average	Avg	At each sweep, averaging calculations are done for each horizontal axis point, and the results are displayed. These results are used for improvement of the S/N ratio.	
Off	Off	At each sweep, the trace data are updated and displayed. These data are used for normal measurement.	

For storage mode, see Figure 3.1.4-2. It is displayed in Trace Parameter.



3.1.2 Averaging function

This function displays the averaged trace results.

Example: To set trace A to Average and the storage count to 100

<Procedure>











1. Press .
2. Press  (Active Trace) and then press  (A).
3. Press  (Storage Mode) and select  (Average).
4. Press  (Storage Count).
5. After pressing   , press  (Set) to set the storage count.

Table 3.1.2-1 shows the calculation method for averaging.

Table 3.1.2-1 When averaging exponent = N

Sweep Count	Measurement Value M (n)	Displayed Value
1	M (1)	$Y (1) = M (1)$
2	M (2)	$Y (2) = Y (1) + \frac{M (2) - Y (1)}{2}$
3	M (3)	$Y (3) = Y (2) + \frac{M (3) - Y (2)}{3}$
...
N - 1	M (N - 1)	$Y (N - 1) = Y (N - 2) + \frac{M (N - 1) - Y (N - 2)}{N - 1}$
N	M (N)	$Y (N) = Y (N - 1) + \frac{M (N) - Y (N - 1)}{N}$
N + 1	M (N + 1)	$Y (N + 1) = Y (N) + \frac{M (N + 1) - Y (N)}{N}$
N + 2	M (N + 2)	$Y (N + 2) = Y (N + 1) + \frac{M (N + 2) - Y (N + 1)}{N}$
...

For storage times, see Figure 3.1.4-2. It is displayed in Trace Parameter.



Display except for Spectrum Emission Mask















Display in % for Spectrum Emission Mask

3.1.3 Max Hold/Min Hold function

This function holds and displays the maximum value (Max Hold) or minimum value (Min Hold) of the trace data.

Example: To set trace A to Max Hold, trace B to Min Hold, and simultaneous display

<Procedure>

1. Press .
2. Press  (Active Trace) and then press  (A).
3. Press  (Trace Type) and then press  (Write).
4. Press  (Storage Mode) and then press  (Max Hold).
5. Press  (Active Trace) and then press  (B).
6. Press  (Trace Type) and then press  (Write).
7. Press  (Storage Mode) and then press  (Min Hold).

3.1.4 Setting wave detection mode

The wave detection mode can be selected from the modes listed in Table 3.1.4-1. When Couple Time/Frequency Domain is set to Off, each parameter is specified in accordance with the already-specified frequency axis or time axis measurement.

Table 3.1.4-1 Wave detection modes

Wave Detection Mode	Description
Pos&Neg	Displays line linking maximum value and minimum value between sample points.
Positive	Displays maximum value between sample points.
Negative	Displays minimum value between sample points.
Sample	Displays instantaneous value between sample points.
RMS	Displays power of 2 average value (effective value) between sample points.

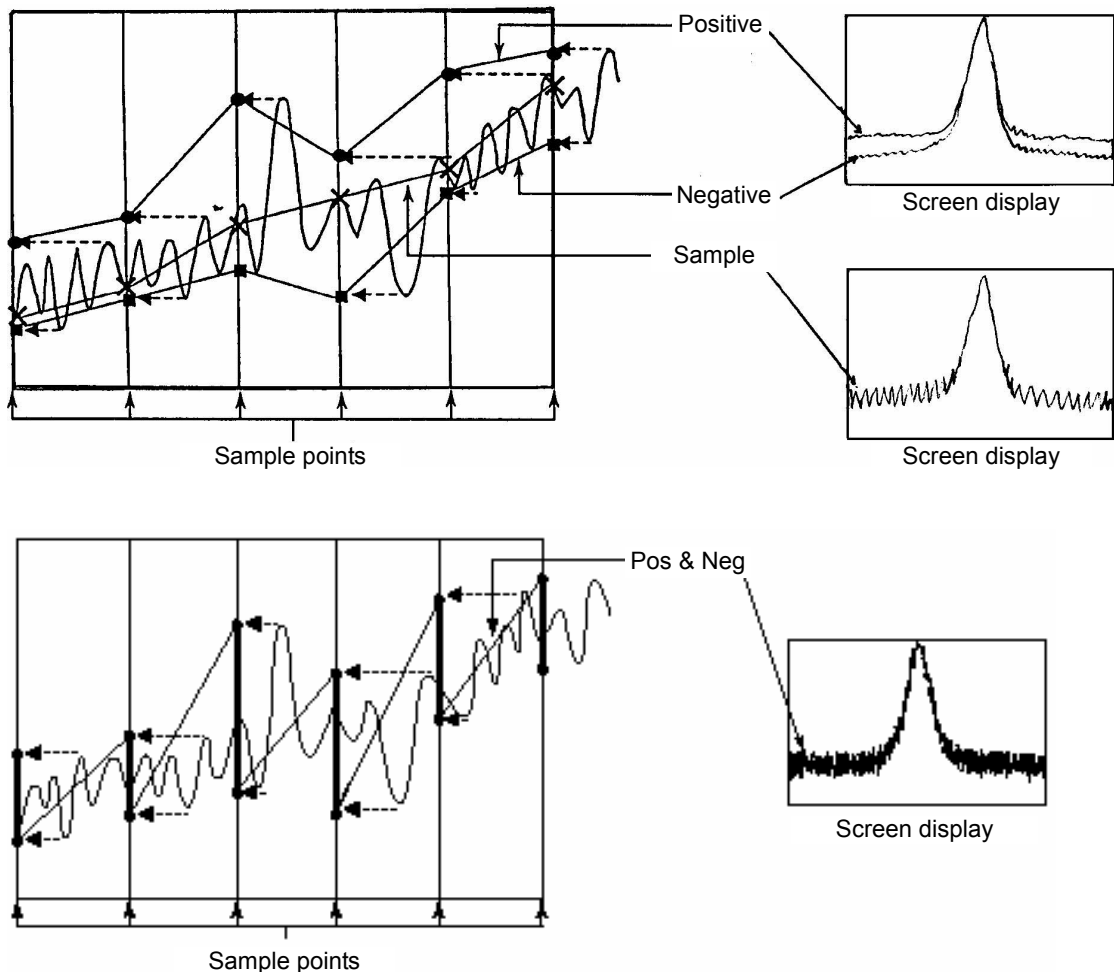
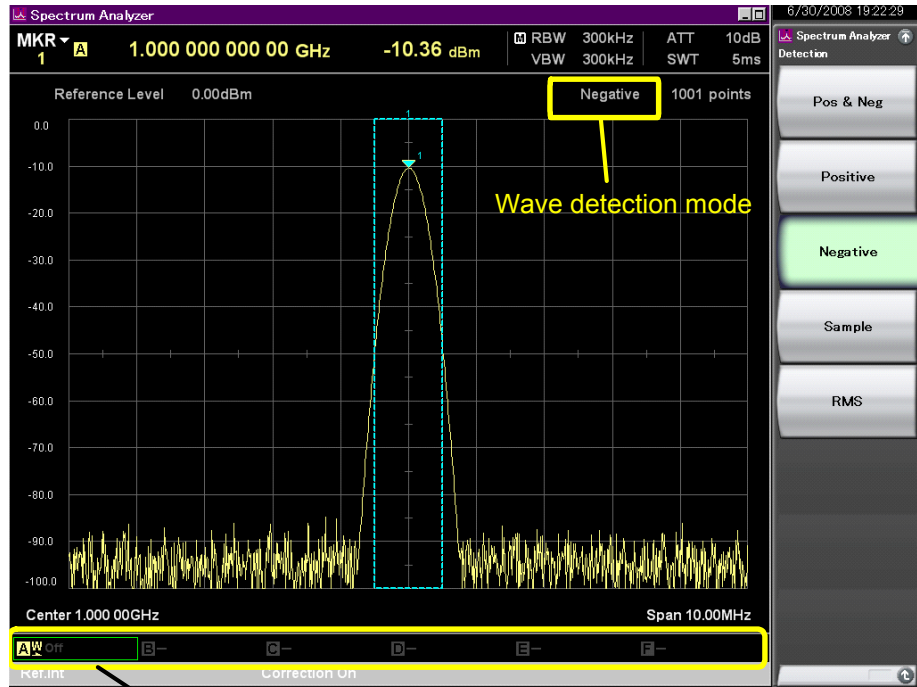

Figure 3.1.4-1 Screen display differences according to wave detection mode

Example: To set the wave detection mode to Negative

<Procedure>

1. Press **Trace**.
2. Press **F8** (Detection) and then press **F3** (Negative).



Trace Parameter

Figure 3.1.4-2 Wave detection mode selection

3.1.5 Displaying and updating Trace

You can configure Trace Type display settings here. Table 3.1.5-1 lists the available options.

Table 3.1.5-1 Trace Type Writing Modes

Trace Type Writing Modes	Display	Description
Write	W	Updates the display per measurement.
View	V	Keeps the current display; it does not update the display per measurement.
Blank	–	No trace is displayed.

For trace type writing mode, see Figure 3.1.4-2. It is displayed in Trace Parameter.



3.2 Setting Limit Line

You can evaluate trace data by drawing Limit Line.

Notes:

- The limit line function is not available when Measure function is set to ON.
- Limit Test (evaluation of trace data) is not performed when, on the Amplitude function menu, the Scale menu is set to **Lin**. The result of Limit Test is displayed as “*** LIMITn”.

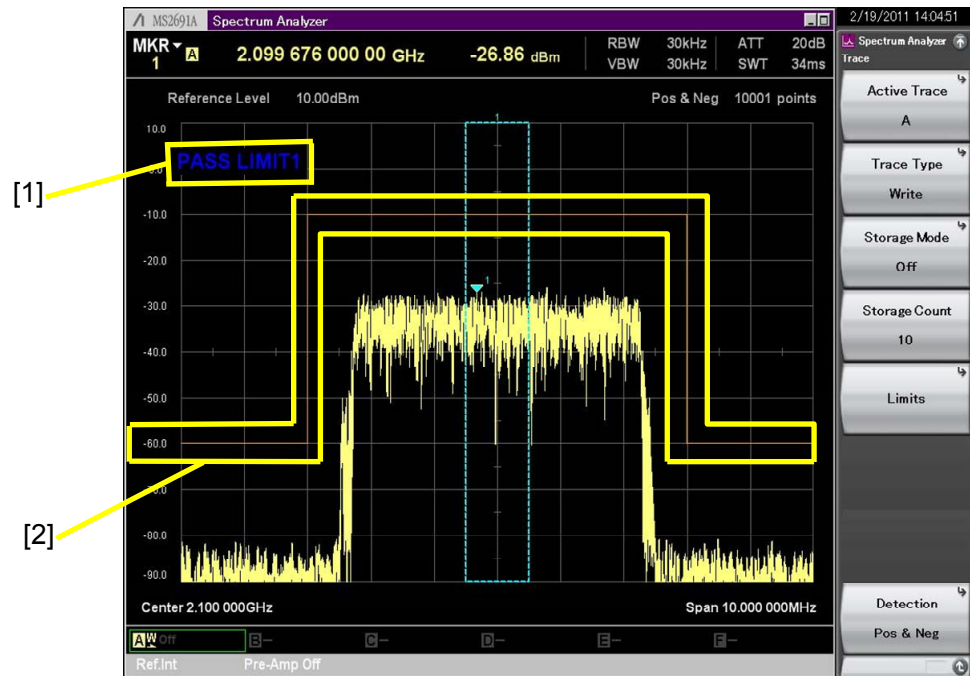

Figure 3.2-1 Display items for the Limit function

Table 3.2-1 Display items for the Limit function

No.	Display	Description
[1]	Limit Test	Displays a Pass/Fail judgment by determining whether or not data is within Limit Line.
[2]	Limit Line	Displays Limit Line.

3.2.1 Setting Limit function parameters

Pressing **F5** (Trace) in the main function menu or pressing **Trace** displays the Trace function menu. Selecting **F5** (Limits) on the Trace function menu displays the Limit function menu.

Example: To draw -20 dBm Limit Line between 1 and 2 GHz in order to determine data as Fail when it exceeds Limit Line

<Procedure>

1. Press **Trace**.
2. Press **F5** (Limits).
3. Press **F7** (Limit1).
4. Press **→** to display page 2. Press **F1** (Limit Line Type (Frequency)) and select **Abs**.
5. Press **F2** (Limit Line Type (Amplitude)) and select **Abs**.
6. Press **→** to display page 1. Press **F1** (Type) to set it to Upper.
7. Press **F2** (Limit Display) to set it to On.
8. Press **F3** (Limit Test) to set it to On.
9. Press **F6** (Edit) and then press **F1** (Point).
10. Press **1** to set Point to Point1.
11. When **F3** (Frequency) is not displayed, press **F2** (Add Point).
12. Press **F3** (Frequency).
13. After pressing **1**, press **F1** (GHz) to set Frequency.
14. Press **F4** (Amplitude).
15. Press **-/+** **2** **0** and then press **F1** (dBm) to set Amplitude.
16. Press **F2** (Add Point).
17. Press **F3** (Frequency).
18. After pressing **2**, press **F1** (GHz) to set Frequency.
19. Press **F4** (Amplitude).
20. Press **-/+** **2** **0** and then press **F1** (dBm) to set Amplitude.
21. Press **F5** (Connected to Previous Pt) and set it to On to connect Point1 and Point2 with a line.

3.2.2 Setting Limits







Selecting  (Limits) on the Trace function menu displays the Limits function menu. You can set six types of Limit Line.

Table 3.2.2-1 Limits function menu

Function key	Menu Display	Function
F1	Limit1	Sets Limit Line 1.  3.2.3 "Setting Limit1 to 6"
F2	Limit2	Sets Limit Line 2.  3.2.3 "Setting Limit1 to 6"
F3	Limit3	Sets Limit Line 3  3.2.3 "Setting Limit1 to 6"
F4	Limit4	Sets Limit Line 4  3.2.3 "Setting Limit1 to 6"
F5	Limit5	Sets Limit Line 5  3.2.3 "Setting Limit1 to 6"
F6	Limit6	Sets Limit Line 6  3.2.3 "Setting Limit1 to 6"
F8	Delete All Limits	Deletes all Point values of Limit Line 1 to 6.

3.2.3 Setting Limit1 to 6







Selecting  (Limit1) to  (Limit6) on the Limits function menu displays the Limit1 to Limit6 function menu.

Table 3.2.3-1 Limit1 to 6 function menus

Function key	Menu Display	Function
Page 1	Limit1 to Limit6	Press  (Limit1) to  (Limit6) on the Limits function menu.
F1	Type	Sets the Limit Line type. Upper: Upper limit (Default) Lower: Lower limit
F2	Limit Display	Sets whether to show or hide Limit Line. On: Display Off: Hide (Default)
F3	Limit Test	Sets whether or not to make a judgment by Limit Line. On: Makes a judgment. Off: Does not make a judgment. (Default)
F4	Margin (On/Off)	Sets whether to display the Margin line. This line is determined by adding Offset to the Limit Line. On: Display Off: Hide (Default)
F5	Margin Value	Sets the Offset value to be added with the Margin line. Range: -40.00 to 0.00 (Upper) 0.00 to 40.00 (Lower) Resolution: 0.01 dB Rotary knob resolution: 0.1 dB Step key resolution: 1 dB Default: 0 dB
F6	Edit	Sets individual Points of Limit Line.  3.2.4 "Edit Parameter"
F7	Envelope	Displays the Envelope-Limit x function menu.  3.2.5 "Limit Envelope Function"
F8	Test Trace*	Sets the test target Trace. Options: A,B,C,D,E,F Default:A

*: When one of the Limit1 to Limit6 function menus is selected, the setting of the Active Trace (F1) on the Trace function menu is set automatically.

Table 3.2.3-1 Limit1 to 6 function menus (Cont'd)

Function key	Menu Display	Function
Page 2	Limit1 to Limit6	Press (Limit1) to (Limit6) on the Limits function menu and then press to display page 2.
F1	Limit Line Type (Frequency)	Sets the mode of setting the frequency axis of the Limit Line. Abs: Absolute value of the frequency Rel: Relative value with respect to the Center Frequency (Default)
F2	Limit Line Type (Amplitude)	Sets the mode of setting the level axis of the Limit Line. Abs: Absolute level (dBm) (Default) Rel: Relative value with respect to the Reference Level (dB)
F4	Save Limit x	Displays the Save Limit function menu. Table 3.2.6-2 Save Limit function menu
F5	Recall Limit x	Displays the Recall Limit1 to 6 function menu. Table 3.2.7-3 Recall Limit1 to 6 function menu
F7	Mirror Limit	Sets whether to mirror (On) or not (Off: Default) the settings for the right half to the left half. This menu is available only when the Limit Line Type (Frequency) menu is set to Rel.

(1) Setting a display format of Limit Line

Example: To display the judgment by Limit Line by displaying Limit1 as Upper Limit and displaying Limit Line

<Procedure>

1. Press .
2. Press (Limits).
3. Press (Limit1).
4. Press (Type) to set it to Upper.
5. Press (Limit Display) to set it to On.
6. Press (Limit Test) to set it to On.









Details for Limit Test

- When Type is Upper and data exceeds Limit Line, the test result will be Fail.
- When Type is Lower and data is below Limit Line, the test result will be Fail.

(2) Margin function

Example: To display a Margin line by adding the Limit Line with -20 dB

<Procedure>

1. Press .
2. Press  (Limits).
3. Press  (Limit1).
4. Press  (Margin) to set it to On.
5. Press  (Margin Value).
6. Press    and then press  (dB) to set Margin Value.

3.2.4 Edit parameters

Selecting  (Edit) on the Limit1 to 6 function menu displays the Edit-Limit x function menu.

Table 3.2.4-1 Edit-Limit x function menu

Function key	Menu Display	Function
F1	Point	Sets the Limit Point you want to edit.
F2	Add Point	Adds a Limit Point with the same frequency and level as the selected Limit Point, on the right of the selected Limit Point.
F3	Frequency*	Sets the Frequency of Limit Point.
F4	Amplitude*	Sets the level of Limit Point.
F5	Connected to Previous Pt(On/Off)*	Sets whether to turn on or off linear interpolation between Pts (Limit Points). Pass/Fail evaluation is performed by making linear interpolation between the current Limit Point selected and the other Limit Point that is located on the nearest left of the current Limit Point.
F6	Previous Pt Level Offset*	Sets the offset value from the current Limit point for connecting Pts (Limit Points) with a line.
F7	Delete Point	Deletes the selected Limit Point.
F8	Delete Limit	Deletes all Limit Points of Limit x.

*: The F3 to F6 function menus are not displayed, when the number of Limit Points is 0.

(1) Setting Point







Point

Setting range:	1 to Limit Points (Max: 100)
Minimum resolution:	1
Rotary knob resolution:	1
Step key resolution:	1

(2) Setting Frequency

Example: To set Frequency to 1 GHz

<Procedure>

1. Press .
2. Press  (Limits).
3. Press  (Limit1).
4. Press  (Edit).
5. Press  (Frequency Offset).
6. After pressing , press  (GHz) to set Frequency Offset.

Frequency

When the Limit Line Type (Frequency) menu is set to **Abs.**

Setting range:	0 to 325 GHz
Default:	Start Frequency
Minimum resolution:	1 Hz
Rotary knob resolution:	1/10000 of the frequency span
Step key resolution:	Step Size

When the Limit Line Type (Frequency) menu is set to **Rel.**

Setting range:	-100 to 100 GHz
Default:	0 Hz
Minimum resolution:	1 Hz
Rotary knob resolution:	1/10000 of the frequency span
Step key resolution:	Step Size









 2.3.2 "Setting frequency span" 2.3.8 "Setting step size"**Notes:**

- When a point's Frequency value is higher than the other points' value and this relationship reverses, the order of points automatically changes.
- When the Limit Line Type (Frequency) is switched, a value exceeding the setting range may be read.

(3) Setting Amplitude

Example: To set Amplitude to -10 dBm

<Procedure>

1. Press .
2. Press  (Limits).
3. Press  (Limit1).
4. Press  (Edit).
5. Press  (Amplitude).
6. Press    and then press  (dBm) to set Amplitude.

Amplitude

When Limit Line Type (Amplitude) is **Abs.**

Setting range:	-300 to 300 dBm
Default:	Reference Level
Minimum resolution:	0.01 dBm
Rotary knob resolution:	1 dBm
Step key resolution:	10 dBm

When Limit Line Type (Amplitude) is **Rel:**

Setting range:	-300 to 300 dB
Default:	0 dB
Minimum resolution:	0.01 dB
Rotary knob resolution:	1 dB
Step key resolution:	10 dB

Note:

When the Limit Line Type (Amplitude) is switched, a value exceeding the setting range may be read.

(4) Connected to Previous Pt

Pass/Fail evaluation between Limit Points is performed by making linear interpolation between the current Limit Point and the other Limit Point that is located on the nearest left of the current Limit Point. Also, linear interpolation can be made with a margin added to.

Linear Interpolation: On

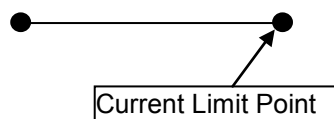

Linear Interpolation: Off



(5) Previous Pt Level Offset

Linear interpolation between Limit Points is performed with respect to “previous Limit Point” and “Offset Point (○) from the current Limit Point”. Limit evaluation will be made according to the Limit Points (●), without including the Offset Point (○).

Linear Interpolation Without Offset

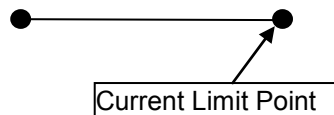

Linear Interpolation With Offset of 3 dB

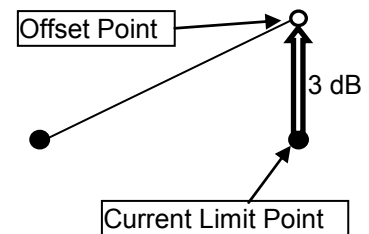



Previous Pt Level Offset

Setting range:	-300.00 to 300.00 dB
Default:	0 dB
Minimum resolution:	0.01 dB
Rotary knob resolution:	1 dB
Step key resolution:	10 dB







(6) Creating a new Limit Line

<Procedure>

1. Press  (Edit).
2. Press  (Add Point).
3. Set the Frequency.
4. Set the Amplitude.
5. Press  (Connected to Previous Pt) and set to On/Off.
6. Set the Previous Pt Level Offset.
7. Repeat steps 3 to 6 until the Limit Points are set.

(7) Adding a new Limit Point to an existing Limit Line

<Procedure>

1. Press  (Edit).
2. Press  (Point).
3. Rotate the rotary knob until the point to add a Limit Point is selected.
4. Press  (Add Point).
5. Press  (Frequency) and set the frequency.
6. Press  (Amplitude) and set the level.
7. Press  (Connected to Previous Pt) and set to On.
8. Press  (Previous Pt Level Offset) and set the offset.

3.2.5 Limit Envelope Function

Selecting **F7** (Envelope) on the Limit1 to 6 function menu displays the Envelope-Limit x function menu.

Set the values of the following: **F4** (Points), **F5** (Offset) and **F6** (Shape). Then, clicking **F1** (Create Envelope) automatically creates Limit Point(s) and Limit Line from the Trace data of the measurement results.

Note:

Pressing **F1** (Create Envelope) or **F2** (Update Envelope Amplitude) clears all Limit Points set in 3.2.4 “Edit parameters”. Then, Limit Points are arranged at regular intervals in the on-screen span, according to the number and shape that are respectively set at **F4** (Points) and **F6** (Shape).

Table 3.2.5-1 Envelope-Limit x function menu

Function key	Menu Display	Function
F1	Create Envelope	Automatically creates a Limit Line from the current Trace data. This menu is unavailable when the Mirror Limit menu is set to On.
F2	Update Envelope Amplitude	Automatically updates a Limit Point of the Peak Level that includes a Trace Point evaluated as “Fail”, referring to the current trace data. This menu is unavailable when the Mirror Limit menu is set to On. This menu is unavailable after editing the Limit Line when Shape is set to Square.
F4	Points	Sets the number of Envelope Points to be arranged when automatically creating a Limit Line. When the Create Envelope menu is executed, the set value applies.
F5	Offset	Sets the offset level (from the current peak Trace Point to the Limit Point). When the Create Envelope or Update Envelope menu is executed, the set value applies.
F6	Shape	Sets the shape of the Limit Line. When the Create Envelope menu is executed, the set value applies. This menu is unavailable when the Mirror Limit menu is set to On. Slope: Connects Limit Points with straight lines. (Default) Square: Connects Limit Points with vertical and horizontal lines.

Create Envelope

Example: When executing the **Create Envelope** menu with the following menu settings:

Type: Upper, Trace Points: 15, Points: 3, Offset: 5 dB, Shape: Slope

The following figure shows a Limit Line (—) and Limit Points (○) that are automatically created with respect to Trace Points (●), peak values for Trace Point values (←→) and offset values (↑).

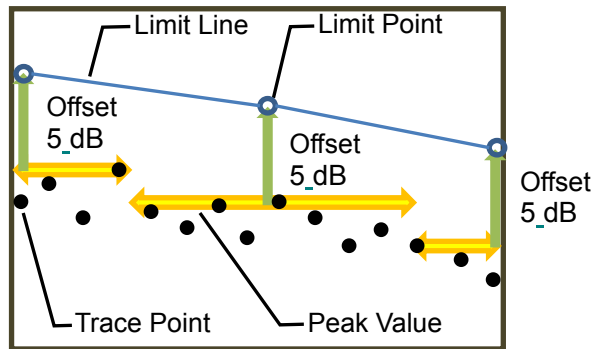

Update Envelope Amplitude

Example: When a Trace Point (●) is evaluated as “Fail” by performing the measurement with the following menu settings:

Type: Upper, Trace Points: 15, Points: 3, Offset: 5 dB, Shape: Slope

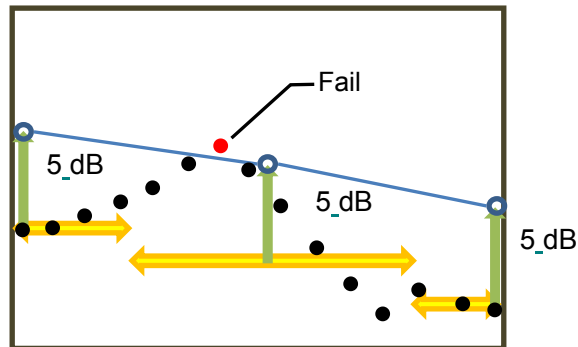

The level of the Limit Point including a Fail Trace Point is recalculated by executing the **Update Envelope Amplitude** menu.

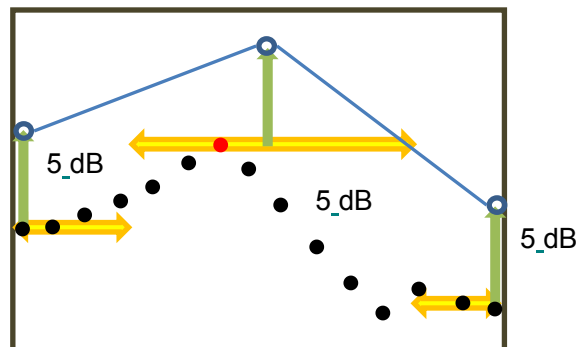

Points

Setting range: When Shape is set to Slope:
 2 to $(\text{Trace Points}-2)\times 2+2$, (Max: 100)
 When Shape is set to Square:
 2 to Trace Points, (Max: 100)

Default: 41

Resolution: 1 (Slope), 2 (Square)

Shape

When Shape is set to Slope:

The number of Limit Points (○) is equal to that of Envelope Points set by **F4** (Points). Limit Line (—) is created by connecting Limit Points (○) by straight lines.

Example: When the number of Envelope Points is 5

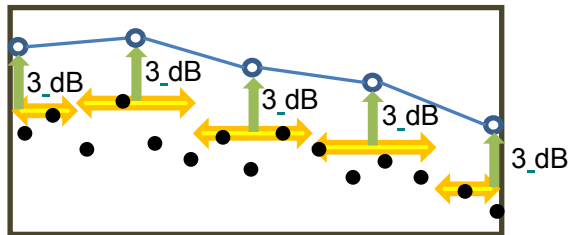

When Shape is set to Square:

The following figure shows the number of Limit Points (○) that depends on the number of Envelope Points (▲) set by **F4** (Points). Limit Line (—) is created by connecting Envelope Points (▲) by straight lines.

Example:

When the number of Envelope Points is an odd number, the number of Limit Points is obtained by the following formula:

$$(\text{The number of Envelope Points}+1)/2$$

When the number of Envelope Points is an even number, the

number of Limit Points is determined by the following formula:

$$(\text{The number of Envelope Points})/2$$

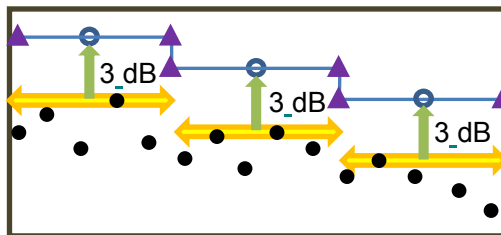

3.2.6 Saving a Limit file





The Save function menu is displayed by pressing  when the Spectrum Analyzer screen is active. For details on the functions, refer to Table 3.2.6-1.

Table 3.2.6-1 Save function menu

Function key	Menu Display	Function
F1	Device	Sets a save destination drive.
F3	Save Limit	Displays the Save Limit function menu.  Table 3.2.6-2 Save Limit function menu
F4	Save on Event	Displays the Save on Event function menu where you can specify whether or not to save Trace data upon occurrence of an event. This function is not available when Measure function is set to ON.  Table 3.4-1 Save on Event function menu
F5	Save Waveform CSV DATA	Saves the displayed waveform data (Trace).  MS2690A/MS2691A/MS2692A Signal Analyzer Operation Manual (Mainframe Operation) Chapter 3 Common Operations
F7	Save Application	Saves the parameter setting conditions of all the launched applications.  MS2690A/MS2691A/MS2692A Signal Analyzer Operation Manual (Mainframe Operation) Chapter 3 Common Operations
F8	Close	Returns to the previous function menu.

On the Save Limit function menu, you can save settings of Limit Line to a file.

Table 3.2.6-2 Save Limit function menu

Function key	Menu Display	Function
F1	Limit1	Saves the settings for Limit Line1 to a file with a specified name.
F2	Limit2	Saves the settings for Limit Line2 to a file with a specified name.
F3	Limit3	Saves the settings for Limit Line3 to a file with a specified name.
F4	Limit4	Saves the settings for Limit Line4 to a file with a specified name.
F5	Limit5	Saves the settings for Limit Line5 to a file with a specified name.
F6	Limit6	Saves the settings for Limit Line6 to a file with a specified name.

Limit1 to Limit6

Pressing the function key displays the dialog box where you can save the Limit Line settings to a file with a specified name.

Save destination for Limit Line files

< D:\¥Anritsu Corporation¥Signal Analyzer¥User Data¥Limit >

Limit Line file Name

Limit“Date”_“Sequential Number”.xml

(Sequential number from 000 to 999. Up to 1000 files can be saved in the folder.)



MS2690A/MS2691A/MS2692A Signal Analyzer
Operation Manual (Mainframe Operation)
Chapter 3 Common Operations

3.2.7 Loading a Limit file





The Recall function menu is displayed by pressing  when the Spectrum Analyzer screen is active. For details on the functions, refer to Table 3.2.7-1. On the Recall function menu, you can load and delete Limit Line files and delete Waveform files.

Table 3.2.7-1 Recall function menu

Function key	Menu Display	Function
F1	Device	Specifies the drive where files are stored.
F3	Recall Limit	Displays the Recall Limit function menu.  Table 3.2.7-2 Recall Limit function menu
F4	Recall Waveform File	Displays the Recall Waveform File function menu.  Table 3.2.7-6 Recall Waveform File function menu
F6	Recall Current Application	Displays the Parameter Save Data List. This function is used when recalling the parameter setting conditions to only the target application.  MS2690A/MS2691A/MS2692A Signal Analyzer Operation Manual (Mainframe Operation) Chapter 3 Common Operations
F7	Recall all Application	Displays the Parameter Save Data List. This function is used when recalling the parameter setting conditions to all the loaded applications.  MS2690A/MS2691A/MS2692A Signal Analyzer Operation Manual (Mainframe Operation) Chapter 3 Common Operations
F8	Close	Returns to the previous function menu.

On the Recall Limit function menu, you can select a Limit Line you want to load or delete Limit Line file(s).

Table 3.2.7-2 Recall Limit function menu

Function key	Menu Display	Function
F1	Limit1	Displays the Recall Limit1 function menu.
F2	Limit2	Displays the Recall Limit2 function menu.
F3	Limit3	Displays the Recall Limit3 function menu.
F4	Limit4	Displays the Recall Limit4 function menu.
F5	Limit5	Displays the Recall Limit5 function menu.
F6	Limit6	Displays the Recall Limit6 function menu.

Load source directory of Limit Line file

< D:\Anritsu Corporation\Signal Analyzer\User Data\Limit>

or



< D:\Anritsu Corporation\Signal Analyzer\User Data\Parameter Setting>

Limit Line file formats that can be recalled

csv, lim, xml

On the Recall Limit1 to 6 function menu, you can select Limit Line file(s) you want to load or delete.

Table 3.2.7-3 Recall Limit1 to 6 function menu

Function key	Menu Display	Function
F1	Device	Selects a device that resides in the folder where the target file is stored.
F3	Delete Files	Displays the Delete Files function menu.  Table 3.2.7-4 Delete Files function menu
F8	Recall	Displays the Recall function menu.  Table 3.2.7-5 Recall function menu

On the Delete Files function menu, you can select and delete Limit Line file(s).

Table 3.2.7-4 Delete Files function menu

Function key	Menu Display	Function
F3	Select All	Selects all files.
F7	Delete	Deletes the selected file(s).
F8	Cancel	Deselects the file(s) and returns to the Recall Limit1 to 6 function menu.

On the Recall function menu, you can load the selected Limit Line file.

Table 3.2.7-5 Recall function menu

Function key	Menu Display	Function
F7	Set	Loads the selected file.
F8	Cancel	Deselects the file and returns to the Recall Limit1 to 6 function menu.

On the Recall Waveform File function menu, you can select Waveform files you want to delete.

Table 3.2.7-6 Recall Waveform File function menu

Function key	Menu Display	Function
F1	Device	Selects a device that resides in the folder where the target file is stored.
F3	Delete Files	Displays the list of Waveform files stored and displays the Delete Files function menu.  Table 3.2.7-7 Delete Files function menu

On the Delete Files function menu, you can select and delete Waveform file(s).

Table 3.2.7-7 Delete Files function menu

Function key	Menu Display	Function
F3	Select All	Selects all files.
F7	Delete	Deletes the selected file(s).
F8	Cancel	Deselects the file(s) and returns to the Recall Waveform File function menu.

3.3 Setting Time/Sweep

Pressing **F8** (Time/Sweep) on the main function menu, or pressing **Time/Sweep** displays the Time/Sweep function menu.



Figure 3.3-1 Time/Sweep key

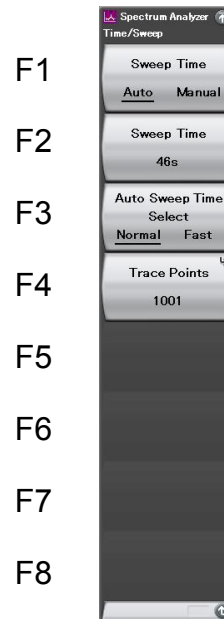





Figure 3.3-2 Time/Sweep function menu

Table 3.3-1 Time/Sweep function menu

Menu Display	Function
Sweep Time (Auto/Manual)	Sets the Auto mode/Manual mode for the sweep time.  3.3.1 "Setting sweep time"
Sweep Time	Sets the sweep time.  3.3.1 "Setting sweep time"
Auto Sweep Time Select (Normal/Fast)	Sets the Normal mode/Fast mode when the sweep time is set to Auto.  3.3.1 "Setting sweep time"
Trace Points	Sets the number of trace points.  3.3.2 "Setting trace point"

3.3.1 Setting sweep time





Set the sweep time. When Auto is set, the optimum value is set automatically. Each parameter is specified in accordance with the already-specified frequency axis or time axis measurement.

Setting range and resolution for Sweep Time

Setting range:	2 ms to 1000 s (in frequency domain) 1 μ s to 1000 s (in time domain)
Resolution	In Frequency Domain 1 ms (2 to 999 ms) 0.1 s (1 to 9.9 s) 1 s (10 to 1000 s)
	In Time Domain 1 μ s (1 to 999 μ s) 0.1 ms (1 to 9.9 ms) 1 ms (1 to 999 ms) 0.1 s (1 to 9.9 s) 1 s (1 to 1000 s)

Example: To set Sweep Time value to 20 s



<Procedure>

1. Press .
2. Press  (Sweep Time).
3. After pressing  , press  (s) to set the Sweep Time.

When the sweep time is set to Auto, Normal mode (normal sweep) / Fast mode (fast sweep) can be set.

Example: To set Fast mode by setting Sweep Time to Auto

<Procedure>

1. Press .
2. Press  (Sweep Time) and select Auto.
3. Press  (Auto Sweep Time Select) and select Fast to set the Fast mode.

3.3.2 Setting trace point







Trace point refers to the number of waveform data points. When Couple Time/Frequency Domain is set to Off, each parameter is specified in accordance with the already-specified frequency axis or time axis measurement. The following numbers of trace points can be selected.

Table 3.3.2-1 Trace Point Setting Range



Condition	Range
Span > 500 MHz	1001, 2001, 5001, 10001, 30001
100 MHz < Span ≤ 500 MHz	101, 201, 251, 401, 501, 1001, 2001, 5001, 10001, 30001
300 Hz ≤ Span ≤ 100 MHz AND Sweep Time > 10 s	101, 201, 251, 401, 501, 1001, 2001, 5001, 10001, 30001
300 Hz ≤ Span ≤ 100 MHz AND Sweep Time ≤ 10 s	11, 21, 41, 51, 101, 201, 251, 401, 501, 1001, 2001, 5001, 10001, 30001
Span = 0 Hz AND Sweep Time > 10 s	101, 201, 251, 401, 501, 1001, 2001, 5001, 10001, 30001
Span = 0 Hz AND Sweep Time ≤ 10 s	11, 21, 41, 51, 101, 201, 251, 401, 501, 1001, 2001, 5001, 10001, 30001

Example: To set the number of trace points to 2001.

<Procedure>

1. Press .
2. Press  (Trace Points).
3. Press     and then press  (Set) to set the number of trace points.

3.4 Save on Event

The Save on Event function menu is displayed by pressing  and  (Save on Event) when the Spectrum Analyzer screen is active. For details on the functions, refer to Table 3.4.1-1.

3.4.1 Setting Save on Event

The Save on Event function saves a waveform upon occurrence of any of the trigger events set by  (Event Type). Continuous file save operations can be performed.

Notes:

- When the Storage Mode is set to other than **Off**, trace data is saved upon occurrence of one of the events specified by the Event Type menu after the number of storages reaches the Storage Count.
- Save operation stops when the free HDD space falls below 1 MB.

Table 3.4.1-1 Save on Event function menu

Function key	Menu Display	Function
F1	Save on Event	Sets whether to turn on or off the Save on Event function. On: Turns on the function. Off: Turns off the function. (Default)
F2	Event Type	Sets events that trigger a file save operation. Limit Fail: Saves a waveform if a Limit evaluation result is Fail. (Default) Limit Pass: Saves a waveform if a Limit evaluation result is Pass. Margin Fail: Saves a waveform if an evaluation result including Margin is Fail. Margin Pass: Saves a waveform if an evaluation result including Margin is Pass. Sweep Complete: Saves a waveform whenever measurement is performed, regardless of the Limit evaluation result.
F3	Save then Stop	Sets whether to perform the Save on Event function only once or perform it continuously. On: Performs only once. Off: Continuously performs. (Default)
F5	File Name	Sets the Filename that is internal data of a Folder.csv file to be saved. Default: LIM

File Name

This menu is used to set the Filename (underlined part of the following) that is internal data of a Waveform file to be saved as Folder.csv when performing the Save on Event function.

Filename,Date,999.500001 MHz,999.501819 MHz,...,1000.500001 MHz

LIM20140416163123000_R.spa,4/16/2014 4:31:23 PM,-98.292000,-98.268000,...,-103.104000

LIM20140416163134000_R.spa,4/16/2014 4:31:34 PM,-102.664000,-102.688000,...,-106.108000

:

If omitted, the following is automatically set.

When Event Type is other than Sweep Complete: LIM

When Event Type is Sweep Complete: EOS

3.4.2 Waveform files for Save on Event

This section describes Waveform files to be saved when the Save on Event function is turned on.

Save destination and load source for Waveform files

After the parameters are set, a folder is created by the name including a timestamp of measurement start. Then, a csv file containing multiple data sets is created and stored in the folder.

Save destination for Waveform files

Example: When starting measurement on April 16 at 15:29, a file save destination is as follows:

```
<D:\¥Anritsu Corporation¥Signal Analyzer¥User Data¥Waveform¥04161529_1>
```

The number of the end of "04161529_1" is incremented automatically in order of "04161529_1", "04161529_2", and "04161529_3." It will be set to "04161530_1" if it will become 15:30.

Waveform file name

Folder.csv

Waveform file format

Example: Event Type: Other than Sweep Complete, Detection: RMS

Filename,Date,999.500001 MHz,999.501819 MHz,...,1000.500001 MHz

LIM20140416163123000_R спа,4/16/2014 4:31:23 PM,-98.292000,-98.268000,...,-103.104000

LIM20140416163134000_R спа,4/16/2014 4:31:34 PM,-102.664000,-102.688000,...,-106.108000

:

LIM20140416164324000_R спа,4/16/2014 4:43:24 PM,-101.460000,-103.128000,...,-106.500000

Example: Event Type: Other than Sweep Complete, Detection: Pos&Neg

Filename,Date,999.500001 MHz,999.501819 MHz,...,1000.500001 MHz

LIM20140416163123000_P спа,4/16/2014 4:31:23 PM,-98.292000,-98.268000,...,-103.104000

LIM20140416163123000_N спа,4/16/2014 4:31:23 PM,-98.294000,-98.269000,...,-103.105000

LIM20140416163134000_P спа,4/16/2014 4:31:34 PM,-102.664000,-102.688000,...,-106.108000

LIM20140416163134000_N спа,4/16/2014 4:31:34 PM,-102.666000,-102.689000,...,-106.109000

:

LIM20140416164324000_P спа,4/16/2014 4:43:24 PM,-101.460000,-103.128000,...,-106.500000

LIM20140416164324000_N спа,4/16/2014 4:43:24 PM,-101.480000,-103.129000,...,-106.700000

Example: Event Type: Sweep Complete, Detection: RMS

Filename,Date,999.500001 MHz,999.501819 MHz,...,1000.500001 MHz

EOS20140416163123000_R спа,4/16/2014 4:31:23 PM,-98.292000,-98.268000,...,-103.104000

EOS20140416163134000_R спа,4/16/2014 4:31:34 PM,-102.664000,-102.688000,...,-106.108000

:

EOS20140416164324000_R спа,4/16/2014 4:43:24 PM,-101.460000,-103.128000,...,-106.500000

Meaning of description in file format

_P: Positive detection, _N: Negative detection, _R: RMS detection,

_S: Sample detection

Chapter 4 Marker Function

This chapter describes the marker functions.

4.1	Setting Marker.....	4-2
4.1.1	Setting normal marker	4-5
4.1.2	Setting delta marker	4-5
4.1.3	Setting zone marker	4-6
4.1.4	Setting marker trace	4-7
4.1.5	Setting active marker.....	4-8
4.1.6	Setting Fixed marker	4-8
4.1.7	Setting Type of Result Display	4-9
4.1.8	Setting Freq. Count	4-11
4.2	Setting Peak Search Function	4-13
4.2.1	Executing Peak search.....	4-17
4.2.2	Executing Next Peak search	4-17
4.2.3	Setting search resolution.....	4-17
4.2.4	Setting search threshold value	4-18
4.2.5	Executing Marker to Center Freq./ Marker to Ref. Level	4-19
4.2.6	Executing Marker Search Function	4-20
4.2.7	Executing Power Peak search	4-21
4.2.8	Executing Next Power Peak search.....	4-21
4.2.9	Executing Min search	4-22
4.2.10	Executing Next Min search.....	4-22
4.2.11	Marker tracking settings	4-22
4.3	Displaying Marker List	4-23

4.1 Setting Marker

Pressing **F5** (Marker) on the main function menu, or pressing **Marker** displays the Marker function menu.

The Marker function menu consists of two pages, which can be toggled by pressing **→**.



Figure 4.1-1 Marker key

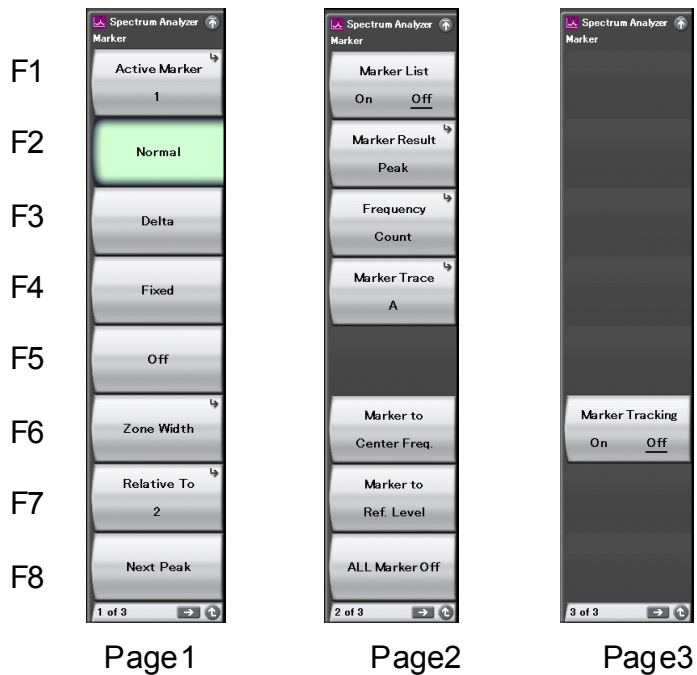

















Figure 4.1-2 Marker function menu

Table 4.1-1 Marker function menu

Menu	Function
Active Marker	Sets the active marker.  4.1.5 "Setting active marker"
Normal	Sets the marker mode to Normal.  4.1.1 "Setting normal marker"
Delta	Sets the marker mode to Delta.  4.1.2 "Setting delta marker"
Fixed	Sets the marker mode to Fixed.  4.1.6 "Setting fixed marker"
Off	Sets the marker display to Off.  4.1.1 "Setting normal marker"
Zone Width	Opens the Zone Width function menu. Set the frequency width for the zone marker.  4.1.3 "Setting zone marker"
Relative To	Sets the reference marker when the active marker is set to Delta.  4.1.2 "Setting delta marker"
Next Peak	Searches for the second biggest peak after the active marker, and moves the marker so that the marker becomes the center frequency of the zone marker.  4.2.2 "Setting Next Peak search"
Marker List (On/Off)	Sets the marker list display to On/Off.  4.3 "Displaying Marker List"
Marker Result	Opens the Marker Result function menu. Set the display type of the marker value.  4.1.7 "Setting Type of Result Display"
Marker Trace	Selects the trace to display the marker.  4.1.4 "Setting marker trace"
Marker to Center Freq.	Sets the presently set marker frequency to the center frequency of the trace.  4.2.5 "Executing Marker to Center Freq. /Marker to Ref. Level"
Marker to Ref. Level	Sets the presently set marker level to the reference level of the trace.  4.2.5 "Executing Marker to Center Freq. /Marker to Ref. Level"
All Marker Off	Sets all the markers to Off.  4.1.1 "Setting normal marker"
Marker Tracking	Conducts sweep after adjusting the center frequency of trace to that of the active marker frequency.  4.2.11 "Marker tracking settings"

Zone Width function menu

Pressing  (Zone Width) on the Marker function menu displays the Zone Width function menu.

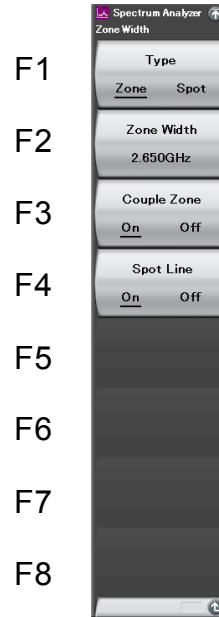





Figure 4.1-3 Zone Width function menu



Table 4.1-2 Zone Width function menu

Menu	Function
Type (Zone/Spot)	Switches between the spot marker and the zone marker.  4.1.3 “Setting zone marker”
Zone Width	Sets the zone marker width of the frequency domain.  4.1.3 “Setting zone marker”
Couple Zone (On/Off)	Sets the Zone Width common setting On/Off. When enabled, the Type and Zone Width settings are shared among all markers. When disabled, a unique setting is possible for each marker.  4.1.3 “Setting zone marker”
Spot Line (On/Off)	Sets the line display of the spot marker to On/Off.  4.1.3 “Setting zone marker”

4.1.1 Setting normal marker



Normal markers are displayed as ▼ and display the frequency (time) and level on the screen.

<Procedure>

1. Press .
2. Press  (Normal) to display the normal markers.
3. Press  (Off) to stop displaying the markers.

Example: To set all the markers to Off.



<Procedure>

1. Press .
2. Press  to display the second page of the Marker function menu and then press  (ALL Marker Off) to set all the markers to Off.

4.1.2 Setting delta marker





The frequency and level at the marker are displayed as values relative to the reference point (marker set by Relative To). If the marker that is set by Relative To is set to Off when this function is executed, the marker is set to a Fixed marker and is displayed as □ on the trace. After that, the relative values of Current marker (▼) and Fixed marker (□) are displayed.

<Procedure>

1. Press .
2. Press  (Delta) and set delta marker.

Example: To set Relative To of marker 1 to marker 3.

<Procedure>

1. Press .
2. Press  (Active Marker) and then press  (Marker1) to set the active marker to 1.
3. Press  (Relative To) and then press  (Marker3) to set Relative To to 3.

4.1.3 Setting zone marker

The area enclosed by the dashed lines in Figure 4.1.3-1 is called a zone marker. The current marker exists within this zone marker and moves to the maximum level point within the range indicated by the zone marker. The frequency (or time) and level at the current marker are displayed on the top part of the screen.

The zone marker can be moved by pressing then operating the rotary knob or step key. The center frequency of the zone marker can also be directly specified from the numeric keypad.

In the frequency domain mode, the zone marker width can be set to an arbitrary value. Spot marker without width can be also set. In the time domain mode, only spot markers can be set.

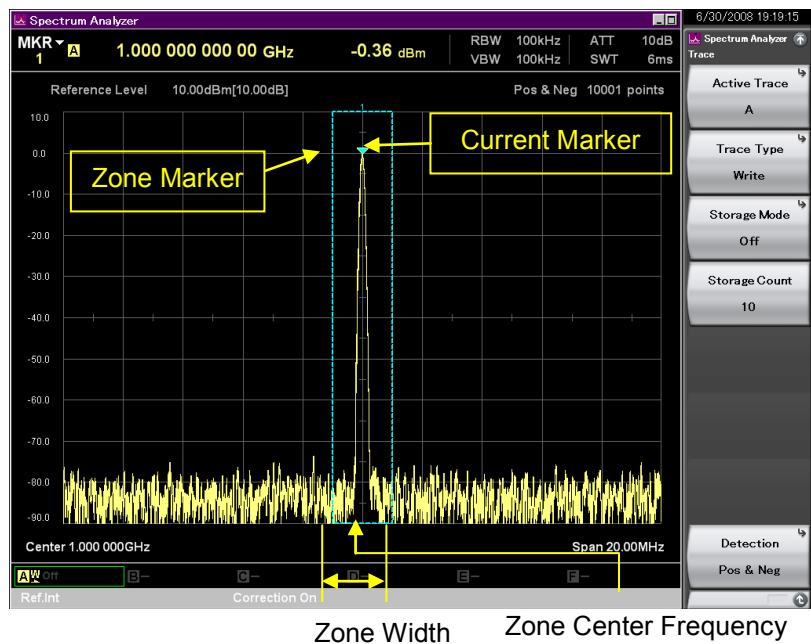

Figure 4.1.3-1 Zone marker and current marker

Example: To set the zone marker width to 10 MHz

<Procedure>

1. Press **Marker**.
2. Press **F6** (Zone Width) to open the Zone Width function menu.
3. After pressing **1** **0**, press **F2** (MHz) and set the zone marker width.

Example: To set the spot marker.

<Procedure>

1. Press **Marker**.
2. Press **F6** (Zone Width) to open the Zone Width function menu.
3. Press **F1** (Type) to select Spot. A spot marker will be set at the point of the center frequency of the zone marker.

Note:

When Marker Result (see 4.1.7) is set to Integration or Density, Type is fixed to Zone, Spot cannot be selected.

Example: To set the line display of the spot marker to Off.

1. Press **Marker**.
2. Press **F6** (Zone Width) to open the Zone Width function menu.
3. Press **F4** (Spot Line) to set Off.

Example: To set Couple Zone to On.

1. Press **Marker**.
2. Press **F6** (Zone Width) to open the Zone Width function menu.
3. Press **F3** (Couple Zone) and select On to set the marker widths in a lump sum.

4.1.4 Setting marker trace

The Spectrum Analyzer function can display multiple traces simultaneously. The traces for marker display can be selected by selecting a marker trace.

Example: To set the marker to trace C

<Procedure>



1. Press **Marker**.
2. Press **F4** (Marker Trace) and select C.

4.1.5 Setting active marker

Select an active marker. You can set the position of the active marker by using the rotary knob and step key.

Example: To set the active marker to 2.

<Procedure>





1. Press .
2. Press  (Active Marker).
3. Press  (Marker 2) to set the active marker to 2.

4.1.6 Setting Fixed marker

The Fixed marker is displayed as  on the screen. It is fixed on the screen and has a fixed value.

Example: To set marker 3 to Fixed marker.

<Procedure>

1. Press .
2. Press  (Active Marker) and then press  to set the active marker to 3.
3. Press  (Fixed) to set to the Fixed marker.

4.1.7 Setting Type of Result Display

The Marker Result function is used to select a type of a marker result.

Marker Result function menu

Press **F2** (Marker Result) on page 2 of the Marker function menu to display the Marker Result function menu.

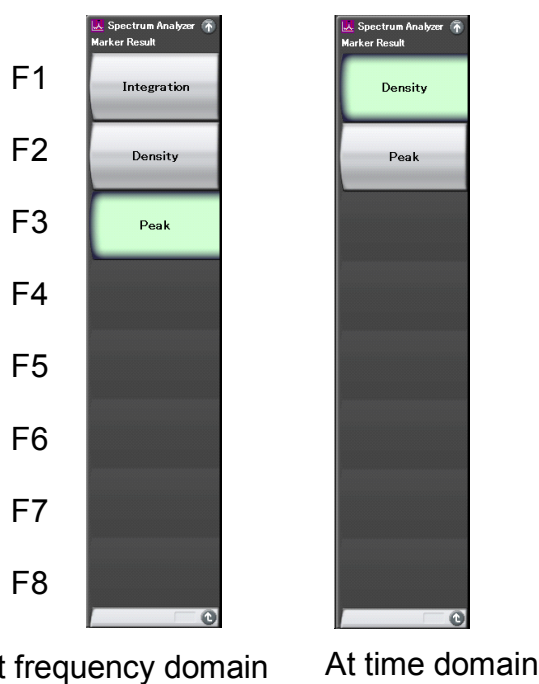

Figure 4.1.7-1 Marker Result function menu

Table. 4.1.7-1 Marker Result function menu

Menu	Function
Integration	Displays the total power in the zone band. It is displayed in the bandwidth of power/marker.
Density	Displays the power per 1 Hz in the zone band. It is displayed in power/Hz units.
Peak	Displays the peak power in the zone. Displays the peak power indicated by the current marker.

This function allows you to select the power (total power, total density, and peak power) displayed in the zone marker.

Example: To display the power per 1 Hz in the zone band.

<Procedure>

1. Press **Marker**.
2. Press **→** to move to page 2 of the Marker function menu, and then press **F2** (Marker Result).
3. Press **F2** (Density) to set to Density.

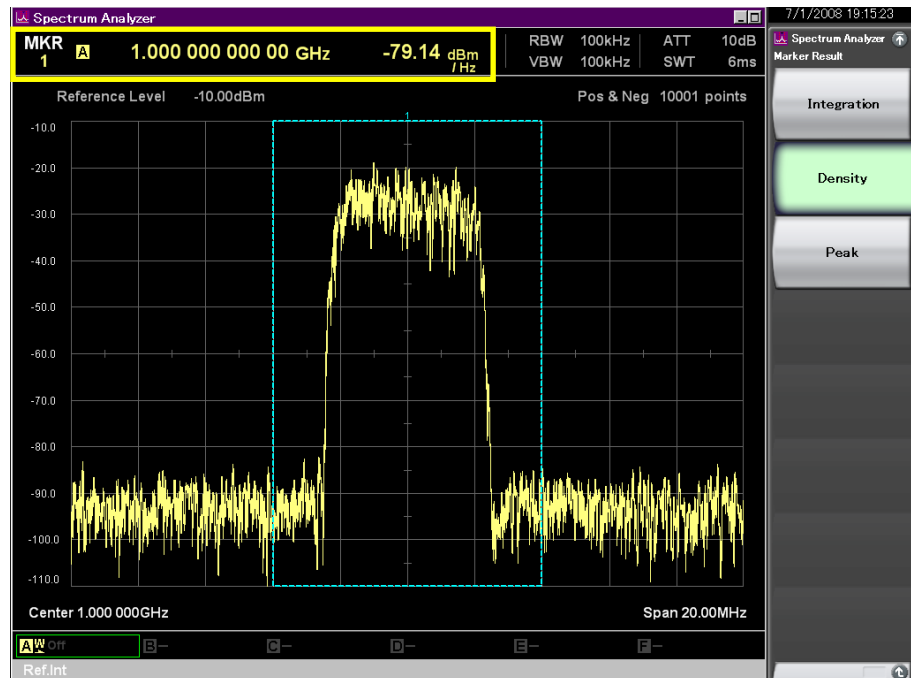

Figure 4.1.7-2 Displaying Power Density

4.1.8 Setting Freq. Count

The Freq.Count function menu is used to set up frequency counter measurement.

Freq. Count function menu

Press **F3** (Freq.Count) in page 2 of Marker function menu to display the Freq.Count function menu.

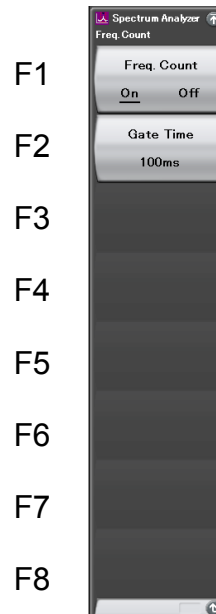

Figure 4.1.8-1 Freq. Count function menu

Table 4.1.8-1 Freq. Count function menu

Function keys	Menu Display	Function
F1	Freq. Count (On Off)	Sets whether to enable or disable frequency counter measurement.
F2	Gate Time	Sets how long to perform frequency counter measurement.

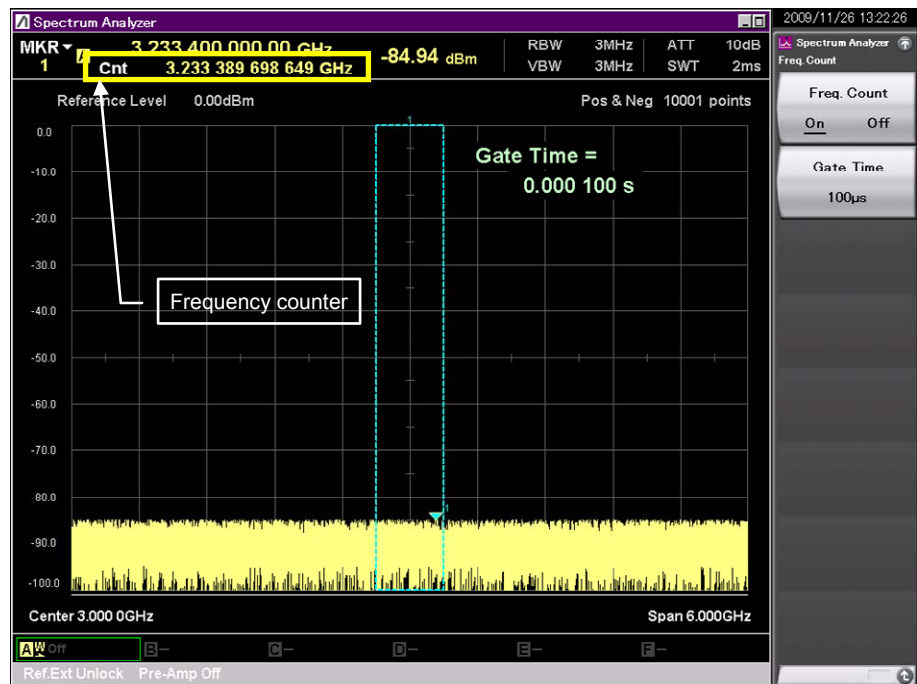

Figure 4.1.8-2 Frequency counter

4.2 Setting Peak Search Function

Four types of peak search function are available, Peak, Next Peak, Min, and Next Min search.

Peak Search function menu

Pressing **F1** (Peak Search) on page 2 of the main function menu, or pressing **Peak Search** displays the Peak Search function menu.



Figure 4.2-1 Peak Search key

4
Marker Function

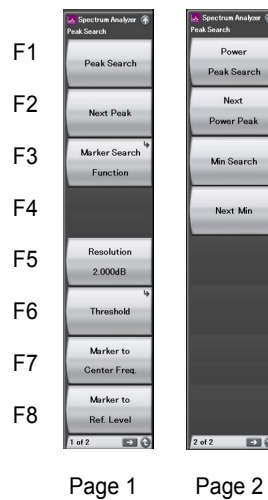











Figure 4.2-2 Peak Search function menu

Table 4.2-1 Peak Search function menu

Menu Display	Function
Peak Search	<p>Moves the marker so that the maximum level point in the measurement band becomes the center frequency of the zone marker.</p> <p> 4.2.1 “Executing Peak search”</p>
Next Peak	<p>Searches for the next peak of the active marker and moves the marker so that it becomes the center frequency of the zone marker.</p> <p> 4.2.2 “Setting next Peak search”</p>
Marker Search Function	<p>Opens the Marker Search function menu. Set the markers in the order of frequency or level .</p> <p> 4.2.6 “Executing Marker Search Function”</p>
Resolution	<p>Sets the resolution for Next Peak and Next Min search.</p> <p> 4.2.3 “Setting search resolution”</p>
Threshold	<p>Sets a threshold value to limit the level points to be searched for.</p> <p> 4.2.4 “Setting search threshold value”</p>
Marker to Center Freq.	<p>Sets the active marker frequency to the center frequency.</p> <p> 4.2.5 “Executing Marker to Center Freq./Marker to Ref. Level”</p>
Marker to Ref. Level	<p>Sets the active marker level to the reference level.</p> <p> 4.2.5 “Executing Marker to Center Freq./Marker to Ref. Level”</p>
Power Peak Search	<p>Moves the active marker to the position where the peak power of the zone width of the active marker becomes maximum in the measurement band.</p> <p> 4.2.7 “Executing Power Peak search”</p>
Next Power Peak	<p>Searches for the next largest peak power in the zone width compared to the total power of the zone width of the active marker in the measurement band and moves the active marker</p> <p> 4.2.8 “Executing Next Power Peak search”</p>
Min Search	<p>Moves the marker so that the minimum level point in the measurement band becomes the center frequency of the zone marker.</p> <p>4.2.9 “Executing Min search”</p>
Next Min	<p>Searches for the next dip of the active marker and moves the marker so that it becomes the center frequency of the zone marker.</p> <p>4.2.10 “Executing Next Min search”</p>

Threshold function menu

Pressing **F4** (Threshold) on the Peak Search function menu displays the Threshold function menu.

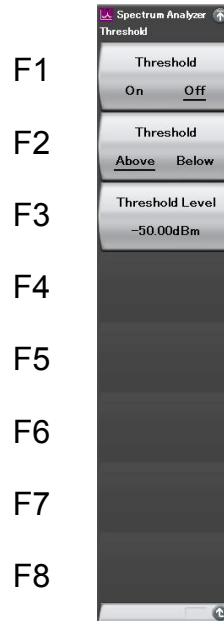





Figure 4.2-3 Threshold function menu

Table 4.2-2 Threshold function menu

Menu Display	Function
Threshold (On/Off)	Switches on/off the detection threshold value function for Peak, Next Peak, Min, and Next Min search.  4.2.4 "Setting search threshold value"
Threshold (Above/Below)	Selects Above (upward search)/Below (downward search) for Peak, Next Peak, Min, and Next Min search.  4.2.4 "Setting search threshold value"
Threshold Level	Sets the threshold value for Peak, Next Peak, Min, and Next Min search.  4.2.4 "Setting search threshold value"

Marker Search Function menu

Press  (Marker Search Function) on the Peak Search function menu to display the Marker Search function menu.

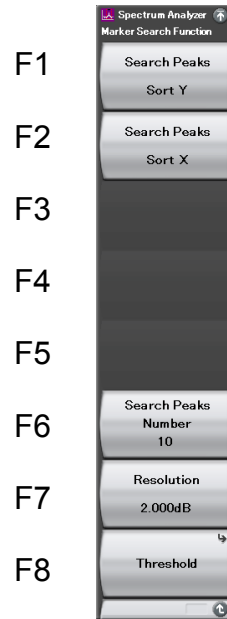







Figure 4.2-4 Marker Search function menu

Table 4.2-3 Marker Search function menu

Menu	Function
Search Peaks Sort Y	Sorts the markers by level in relation to the peaks on the trace of the number specified in Search Peaks Number.  4.2.6 "Executing Marker Search Function"
Search Peaks Sort X	Sorts the markers by frequency (time) in relation to the peaks on the trace of the number specified in Search Peaks Number.  4.2.6 "Executing Marker Search Function"
Search Peaks Number	Sets the number of searches when Search Peaks Sort Y/X is executed.  4.2.6 "Executing Marker Search Function"
Resolution	Sets the resolution of the search.  4.2.3 "Setting search resolution"
Threshold	Sets the threshold of the search.  4.2.4 "Setting search threshold value"

4.2.1 Executing Peak search

Detects the maximum level point from the trace in the display and moves the marker.

If there are several peak points, the marker moves to the point with smallest frequency (or time) (left side of scale).

The Peak search execution procedure is as follows:

<Procedure>

1. Press .
2. Press  (Peak Search) to execute Peak search.



4.2.2 Executing Next Peak search

Detects the next peak of the active marker and moves the marker.

If there are several peak points, the marker moves to the point with smallest frequency (or time) (left side of scale).

The Next Peak search execution procedure is as follows:

<Procedure>





1. Press .
2. Press  (Next Peak) and execute Next Peak search.

4.2.3 Setting search resolution

This sets the peak resolution. It is used when executing Peak, Next Peak, Min, and Next Min search. Peaks below the specified resolution are not detected.

Example: To set the search resolution value to 30 dB.

<Procedure>









1. Press .
2. Press  (Resolution).
3. After pressing  , press  (dB) and set the search resolution.

4.2.4 Setting search threshold value

Specify the threshold value with the Peak detection level. This also become the threshold value for the Min search. The threshold value is displayed on the screen, and search upward or downward from this level can be specified.

Example: To set the search threshold value to –30 dBm or more.

<Procedure>

1. Press .
2. Press  (Threshold).
3. Press  (Threshold) and switch to On.
4. Press  (Threshold Level), then press    and press  (dBm).
5. Press  (Threshold) and select “Above.”

4.2.5 Executing Marker to Center Freq./Marker to Ref. Level

The center frequency and reference level of the trace can be adjusted to match the frequency and level of the active marker.

- Marker to Center Freq. Sets the marker frequency to the center frequency.
(Effective only when frequency span > 0)
- Marker to Ref. Level Sets the marker level to the reference level.

Example: To set the marker frequency to the center frequency

<Procedure>

1. Press **Marker**.
2. Press **F1** (Marker to Center Freq.) on page 2 of the Marker function menu, and set the marker frequency.

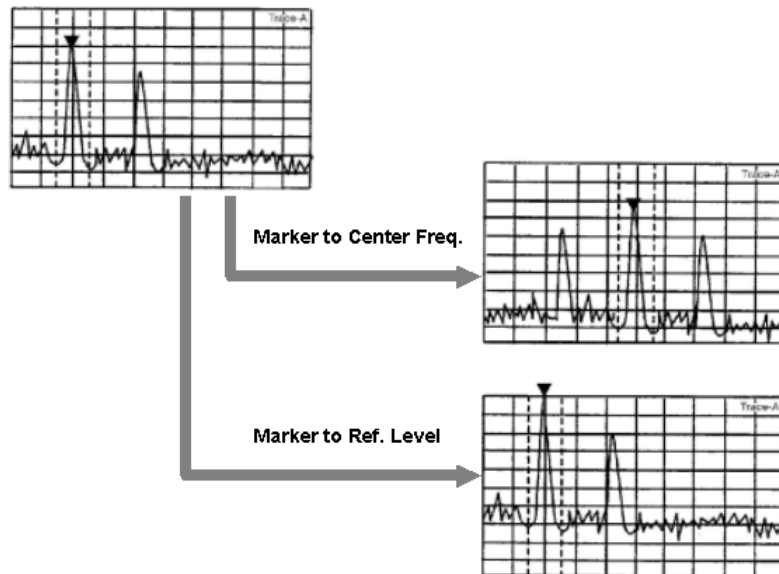

Figure 4.2.5-1 Marker to Center Freq. or Marker to Ref. Level execution

4.2.6 Executing Marker Search Function

Sorts the markers set by Search Peaks Number by frequency (time) or level.

Note:

Marker Search Function can be executed when Marker Result is set to Peak.



Example: To sort three markers by level.

<Procedure>

1. Press **Peak Search**.
2. Press **F6** (Search Peaks Number) after pressing **F3** (Marker Search Function), and then press **3** to set the number of markers to 3.
3. Press **F1** (Search Peaks Sort Y) to sort the markers by level.

Example: To sort the markers by frequency.

<Procedure>

1. Press **Peak Search**.
2. Press **F3** (Marker Search Function).
3. Press **F2** (Search Peaks Sort X) to sort the markers by frequency.

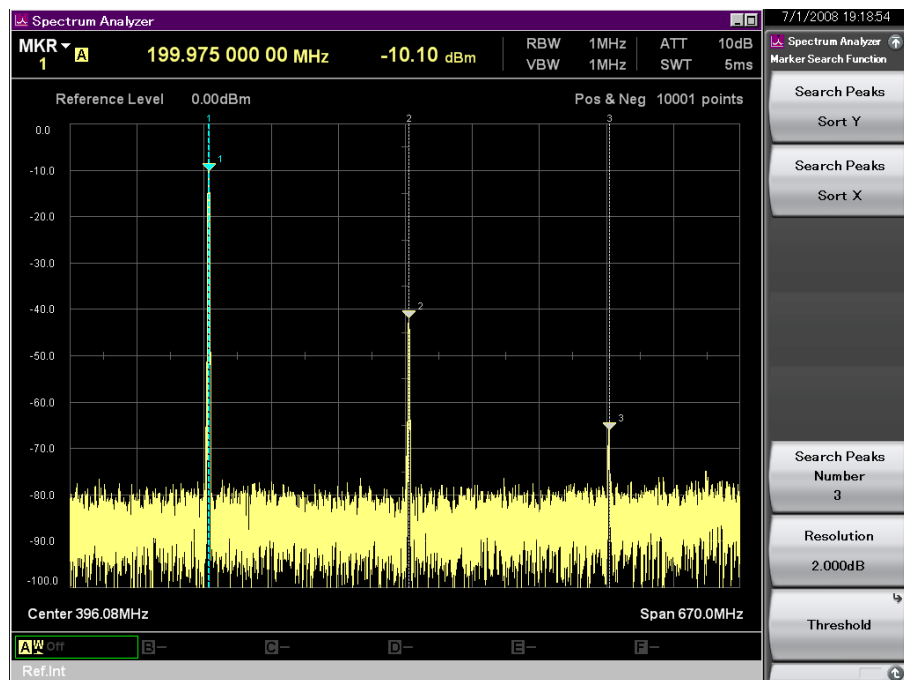

Figure 4.2.6-1 Sorting markers by level

4.2.7 Executing Power Peak search

This command moves the active marker to the position where the peak power of the zone width of the active marker becomes maximum in the measurement band.

If there are several peak points, the marker moves to the point with lowest frequency (left side of scale).

This function is not available when in the time domain mode.



Note:

When executing this function when Marker Result is Peak, Marker Result is set to Integration automatically.

 4.1.7 "Setting Type of Result Display"

Execute Power Peak search as follows:

<Procedure>

1. Press .
2. Press  to display Page 2 of the Peak Search function menu.
3. Press  (Power Peak Search) to conduct Power Peak search.

4.2.8 Executing Next Power Peak search

This command searches for the next largest peak power in the zone width compared to the total power of the zone width of the active marker in the measurement band and moves the active marker.

If there are several peak points, the marker moves to the point with lowest frequency (left side of scale).

This function is not available when in the time domain mode.



Note:

When executing this function when Marker Result is Peak, Marker Result is set to Integration automatically.

 4.1.7 "Setting Type of Result Display"

Execute Power Peak search as follows:

<Procedure>



1. Press .
2. Press  to display Page 2 of the Peak Search function menu.
3. Press  (Next Power Peak) to conduct Next Power Peak search.

4.2.9 Executing Min search

This command moves the marker so that the minimum level point in the measurement band becomes the center frequency of the zone marker.

Execute Min search as follows:

<Procedure>



1. Press .
2. Press  to display Page 2 of the Peak Search function menu.
3. Press  (Min Search) to conduct Min search.

4.2.10 Executing Next Min search

This command searches for the next dip of the active marker and moves the marker so that it becomes the center frequency of the zone marker.

Execute Next Min search as follows:

<Procedure>

1. Press .
2. Press  to display Page 2 of the Peak Search function menu.
3. Press  (Next Min) to conduct Next Min search.

4.2.11 Marker tracking settings

This allows you to conduct sweep after adjusting the center frequency of trace to that of the active marker frequency.

Example: To enable marker tracking function

<Procedure>

1. Press .
2. To configure the settings, press  (Marker Tracking) on page 3 of Marker function menu.

4.3 Displaying Marker List

Displays the marker result list. The marker frequency and power are displayed on the list.

Example: To set the marker display to On.

<Procedure>

1. Press **Marker**.
2. After pressing **→** to move to page 2 of the Marker function menu, press **F1** (Marker List) to set to On.

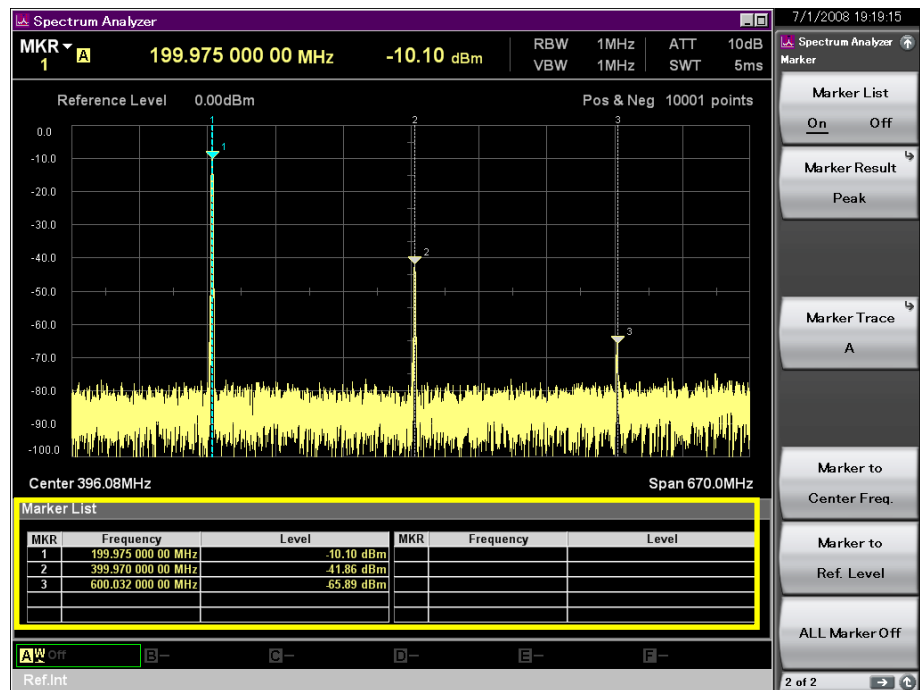

Figure 4.3-1 Displaying marker list

Table 4.3-1 Descriptions of marker list display items

Item	Description
MKR	Displays the marker number. When a number is displayed, it indicates a marker number. When Δ is displayed, it indicates the level or frequency difference between the active marker and the marker set by Relative To. When □ is displayed, it indicates a Fixed marker.
Frequency	Displays the marker frequency.
Level	Displays the marker level. The result selected in Marker Result is displayed in the units specified in Scale Unit. When Δ is displayed, the level of the active marker is displayed as a value relative to the marker set by Relative To.

4
Marker Function

Chapter 5 Trigger Function and Gate Function

This chapter describes the trigger function and the gate function.

5.1	Setting Trigger Function	5-2
5.1.1	Trigger sweep	5-4
5.2	Setting Gate Function	5-7
5.2.1	Gate sweep	5-7
5.2.2	Gate View	5-11

5.1 Setting Trigger Function

Pressing **F7** (Trigger/Gate) from the main function menu, or pressing **Trigger/Gate** displays the Trigger function menu.

The Trigger function menu consists of two pages, which can be toggled by pressing **→**.



Figure 5.1-1 Trigger/Gate key

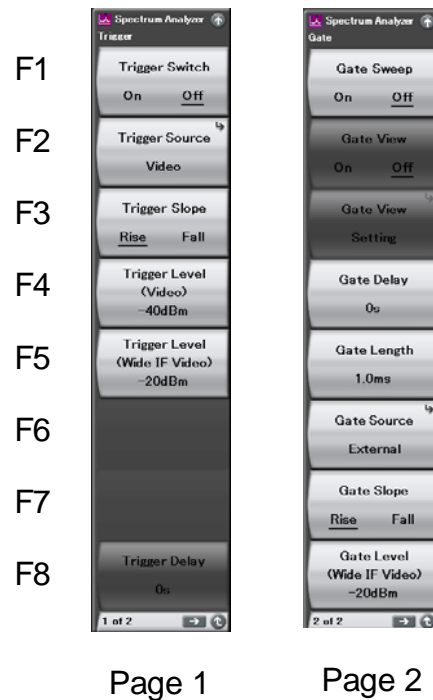















Figure 5.1-2 Trigger function menu

Table 5.1-1 Trigger function menu

Menu Display	Function
Trigger Switch (On/Off)	Enables the trigger function.  5.1.1 "Trigger sweep"
Trigger Source	Selects the trigger source.  5.1.1 "Trigger sweep"
Trigger Slope (Rise/Fall)	Selects the trigger detection method (rise or fall).  5.1.1 "Trigger sweep"
Trigger Level (Video)	Sets the trigger level for the video trigger.  5.1.1 "Trigger sweep"
Trigger Level (Wide IF Video)	Sets the trigger level for the wide IF video trigger.  5.1.1 "Trigger sweep"
Trigger Delay	Sets the trigger delay time.  5.1.1 "Trigger sweep"
Gate Sweep (On/Off)	Enables the gate function.  5.2.1 "Gate sweep"
Gate View (On/Off)	Displays the gate view.  5.2.2 "Gate view"
Gate View Setting	Configures settings related to the gate view.  5.2.2 "Gate view"
Gate Delay	Sets the gate delay.  5.2.1 "Gate sweep"
Gate Length	Sets the gate length.  5.2.1 "Gate sweep"
Gate Source	Selects the gate source.  5.2.1 "Gate sweep"
Gate Slope (Rise/Fall)	Selects the gate detection method (rise or fall).  5.2.1 "Gate sweep"
Gate Level (Wide IF Video)	Sets the trigger level for the wide IF video trigger during gate sweep.  5.2.1 "Gate sweep"

5.1.1 Trigger sweep

Trigger sweep executes sweep using the specified trigger condition as the start point. A delay time until sweep start can be set through trigger delay. Trigger delay can be set only in the time domain mode.

The trigger source can be selected from the following:

- Video trigger
- Wide IF video trigger
- External trigger
- SG marker trigger
- BBIF









Setting range and resolution for trigger level (video)

Setting range:	-150 to +50 dBm	(Log scale)
	0 to 100%	(Lin scale)
Resolution:	1 dBm	(Log scale)
	1%	(Lin scale)

(1) Video trigger

Trigger sweep starts in synchronization with the rise or fall of the waveform. A trigger level indicator showing the trigger level is displayed on the screen.

Example: To set the trigger level to +40 dBm, and trigger slope to Rise
<Procedure>

1. Press .
2. Press  (Trigger Source) and then press  (Video).
3. Press  to return to the previous menu.
4. Press  (Trigger Level (Video)).
5. After pressing  , press  (dBm) to set the trigger level.
6. Press  (Trigger Slope) and select Rise.

(2) Wide IF video trigger

An IF signal with a wide passing band of about 50 MHz is detected, and sweep starts in synchronization with either the rise or fall of the detected signal.











Setting range and resolution for trigger level (wide IF video trigger)

Setting range: -60 to +50 dBm

Resolution: 1 dBm

Example: To set the trigger level to -30 dBm and trigger slope to Fall

<Procedure>





1. Press .
2. Press  (Trigger Source) and then press  (Wide IF Video).
3. Press  to return to the previous menu.
4. Press  (Trigger Level (Wide IF Video)).
5. After pressing   , press  (dBm) to set the trigger level.
6. Press  (Trigger Slope) and select Fall.

(3) External trigger

Sweep starts in synchronization with the rise or fall of the signal input via the Trigger Input connector.

Example: To set the trigger source to external and trigger slope to Rise

<Procedure>

1. Press .
2. Press  (Trigger Source) and select  (External).
3. Press  to return to the previous menu.
4. Press  (Trigger Slope) and select Rise.





(4) SG marker trigger

Note:

This function can be set only when Option 020 Vector Signal Generator (hereinafter, referred to as “Option 020”) is installed.

Sweep starts in synchronization with the rise or fall of the marker signal output of the Option 020. This function allows measurement in synchronization with the output signal of the Option 020. For the marker signal settings, refer to the MS2690A/MS2691A/MS2692A Option 020 Vector Signal Generator Operation Manual (Operation).

<Procedure>

1. Press .
2. Press  (Trigger Source) and then press  (SG Marker).
3. Press  to return to the previous menu.
4. Press  (Trigger Slope) and select either Rise or Fall.





(5) BBIF trigger

Note:

This function is unavailable when the Option 040 Baseband Interface Unit (hereafter Option 040) is not installed or the software package is Ver.6.00.00 or later.

Sweep starts in synchronization with the rise or fall of the trigger signal output of the Option 040. For the settings of BBIF trigger signals, refer to “MX269041A Digital I/F Control Software for DigRF2.5G/3G Operation Manual (BBIF Operation)”.

<Procedure>

1. Press .
2. Press  (Trigger Source) and then press  (BBIF).
3. Press  to return to the previous menu.
4. Press  (Trigger Slope) and select either Rise or Fall.

5.2 Setting Gate Function

5.2.1 Gate sweep

Gate sweep executes sweep only for the length of time specified with the gate length. The sweep start point is determined by adding a delay time specified with the gate delay to the time when the trigger condition is met.

The gate source can be selected from the following:

- Wide IF video trigger
- External trigger
- SG marker trigger
- BBIF

Setting range and resolution for gate delay

Setting range: 0 to 1 s

Resolution: 20 ns

Setting range and resolution for gate length

Setting range: 50 μ s to 1 s





















Resolution: 20 ns

(1) Wide IF video trigger

An IF signal with a wide passing band of approximately 50 MHz is detected and sweep starts in synchronization with either the rise or fall of that signal.

Example: To set the gate delay to 100 ns, gate length to 500 μ s, and gate level to -30 dBm

<Procedure>

1. Press .
2. Press  (Gate Sweep) from page 2 of the Trigger function menu, and select "On."
3. Press  (Gate Source) and press  (Wide IF Video).
4. Press  to return to the previous menu.
5. Press  (Gate Delay), press   , and then press  (ns).
6. Press  (Gate Length), press   , and then press  (μ s).
7. Press  (Gate Level (Wide IF Video)), press   , and then press  (dBm).

Setting range and resolution for gate level (wide IF video trigger)

Setting range: -60 to +50 dBm















Resolution: 1 dBm

(2) External trigger

Sweep is executed only for the gate length time, using the rise or fall of the signal input to the External Input connector as the start point.

Example: To set the gate delay to 100 μ s, gate length to 300 μ s, and gate slope to Fall

<Procedure>

1. Press .
2. Press  (Gate Source) from page 2 of the Trigger function menu, and then press  (External).
3. Press  to return to the previous menu.
4. Press  (Gate Delay), press   , and then press  (μ s) and set the gate delay.
5. Press  (Gate Length), press   , and then press  (μ s) and set the gate length.
6. Press  (Gate Slope) and select Fall.

(3) SG marker trigger















Note:

This function can be set only when Option 020 is installed.

Gate sweep starts in synchronization with the rise or fall of the marker signal output of the Option 020. Measurement can be done in synchronization with the output signal through this function. For the marker signal settings, refer to the MS2690A/MS2691A/MS2692A Option 020 Vector Signal Generator Operation Manual (Operation).

Example: To set the gate delay to 200 μ s, gate length to 100 ms, and gate slope to Rise.

<Procedure>

1. Press .
2. Press  (Gate Source) from page 2 of the Trigger function menu, and then press  (SG Marker).
3. Press  to return to the previous menu.
4. Press  (Gate Delay), press   , and then press  (μ s) and set the gate delay.
5. Press  (Gate Length), press   , and then press  (ms) and set the gate length.
6. Press  (Gate Slope) and select Rise.

(4) BBIF trigger















Note:

This function is unavailable when the Option 040 is not installed or the software package is Ver.6.00.00 or later.

Using a BBIF trigger enables the starting of a gate sweep synchronized with the rising or falling of the trigger output signal from Option 040. For the settings of BBIF trigger signals, refer to “MX269041A Digital I/F Control Software for DigRF2.5G/3G Operation Manual (BBIF Operation)”.

Example: To set the gate delay to 100 ms, gate length to 100 ms, and gate slope to Rise.

<Procedure>

1. Press .
2. Press  (Gate Source) on page 2 of the Trigger function menu, and then press  (BBIF).
3. Press  to return to the previous menu.
4. Press  (Gate Delay), press   , and then press  (μ s) to set the gate delay.
5. Press  (Gate Length), press   , and then press  (ms) to set the gate length.
6. Press  (Gate Slope) and select Rise.

5.2.2 Gate View

This section describes the gate view. An assistant view (the gate view) for setting up the gate sweep segment is displayed on the lower part of the screen when Gate View is set to On. By using the gate view, you can set up the gate sweep segment while checking the spectrum.

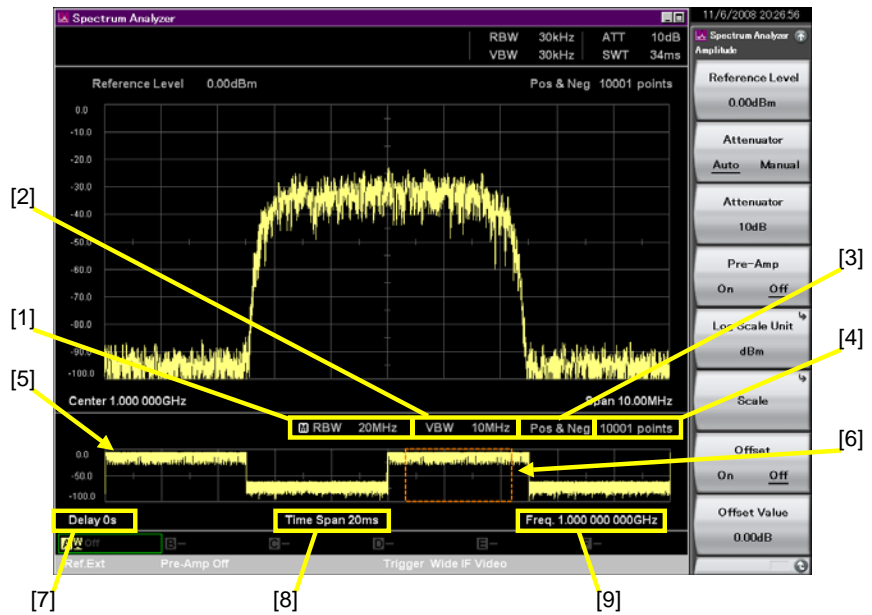

Figure 5.2.2-1 Gate View

Table 5.2.2-1 Displayed items for Gate View

No.	Item	Descriptions
[1]	RBW	Displays the resolution bandwidth (RBW).
[2]	VBW	Displays the video bandwidth (VBW).
[3]	Detection mode	Displays the detection mode.
[4]	Number of trace points	Displays the number of trace points.
[5]	Time domain waveform	Displays the time domain waveform.
[6]	Gate sweep segment	Displays the gate sweep segment as an orange dashed line.
[7]	Trigger delay	Displays the trigger delay.
[8]	Time span	Displays the time span (sweep time).
[9]	Center Frequency	Displays the center frequency.

Pressing **F3** (Gate View Setting) on page 2 of the Trigger function menu displays the Gate View Setting function menu.

This menu consists of two pages that are toggled by pressing **→**.

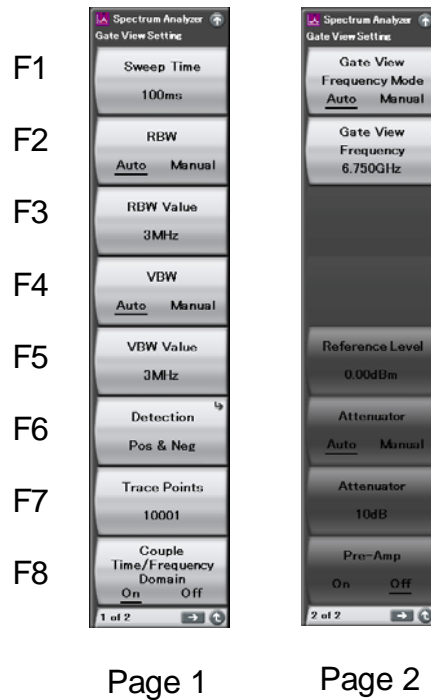

Figure 5.2.2-2 Gate View Setting function menu

Table 5.2.2-2 Gate View Setting function menu

Menu Display	Function
Sweep Time	Sets the sweep time. The specified time is the display time span for the gate view, not the segment in which the gate sweep is executed. For details about the gate sweep segment, see Section 5.2.1 “Gate Sweep.”
RBW (Auto/Manual)	Selects auto setting or manual setting for the resolution bandwidth (RBW). 3 MHz is set for RBW when the auto setting is selected. The setting of RBW Value is set for the resolution bandwidth when the manual setting is selected.
RBW Value	Sets the resolution bandwidth (RBW). Select any one of the followings: 30 Hz, 100 Hz, 300 Hz, 1 kHz, 3 kHz, 10 kHz, 30 kHz, 100 kHz, 300 kHz, 1 MHz, 3 MHz, 5 MHz, 10 MHz, 20 MHz, 31.25 MHz

Table 5.2.2-2 Gate View Setting function menu (Cont'd)



Menu Display	Function
VBW (Auto/Manual)	<p>Selects auto setting or manual setting for the video bandwidth (VBW).</p> <p>The value that is the same as or closest to the resolution bandwidth (RBW) is set when Auto (the auto setting) is selected.</p> <p>The setting of VBW Value is set for the video bandwidth (VBW) when Manual (the manual setting) is selected.</p> <p>This menu item is disabled when Detection is set to RMS.</p>
VBW Value	<p>Sets the video bandwidth (VBW).</p> <p>This menu item is disabled when Detection is set to RMS. VBW Mode can be set on the BW function menu.</p> <p> 2.5.3 "Setting Video VBW/Power VBW"</p>
Detection	Sets the detection mode.
Trace Point	Sets the number of trace points.
Couple Time/Frequency Domain	<p>Sets whether to couple the time domain parameters and frequency domain parameters.</p> <p> 2.3.7 "Setting Whether To Couple Time Domain Parameters and Frequency Domain Parameters"</p>
Gate View Frequency Mode (Auto/Manual)	<p>Selects auto setting or manual setting for the center frequency.</p> <p>The center frequency for the frequency domain is set when Auto (the auto setting) is selected.</p> <p>The setting of Gate View Frequency is set when Manual (the manual setting) is selected.</p>
Gate View Frequency	Sets the center frequency.
Reference Level	<p>Sets the reference level when Spurious Emission is set to On.</p> <p>The reference level for the frequency domain is set and this menu item is disabled when Spurious Emission is set to Off.</p>
Attenuator (Auto/Manual)	<p>Selects the auto setting or manual setting for the attenuator when Spurious Emission is set to On.</p> <p>The attenuator setting mode (Auto or Manual) for the frequency domain is selected and this menu item is disabled when Spurious Emission is set to Off.</p>

Table 5.2.2-2 Gate View Setting function menu (Cont'd)

Menu Display	Function
Attenuator	Sets the attenuator when Spurious Emission is set to On. The attenuator for the frequency domain is set and this menu item is disabled when Spurious Emission is set to Off.
Pre-Amp (On/Off)	Sets Pre-Amp function On/Off when Spurious Emission is set to On. The Pre-Amp On/Off setting for the frequency domain is set and this menu item is disabled when Spurious Emission is set to Off. Moreover, this menu item is also disabled when the Option 008 6GHz Preamplifier is not installed.

Chapter 6 Preselector Tuning Function

This chapter describes the preselector tuning function of the MS2691A/MS2692A.

6.1 Preselector Tuning Function.....6-2

6.1 Preselector Tuning Function

Note:

This function can be executed only in the MS2691A/MS2692A.
This cannot be set when MS2692A-067 is installed and Preselector Bypass is set to On.

The MS2691A/MS2692A uses a preselector to remove unwanted responses such as image response and multiple responses, so that only the true signal is represented on the screen display. The preselector is a tunable bandpass filter that follows the reception frequency of the analyzer. To perform correct adjustment with the preselector, it is necessary to perform adjustment of the peaking bias.

The MS2691A/MS2692A being adjusted prior to shipping, peaking bias adjustment is not required for normal use. However, if the tuning frequency is incorrect, the reception level decreases, so a function for adjusting the tuning frequency of the preselector (preselector tuning function) is provided to enable obtainment of the highest possible response.

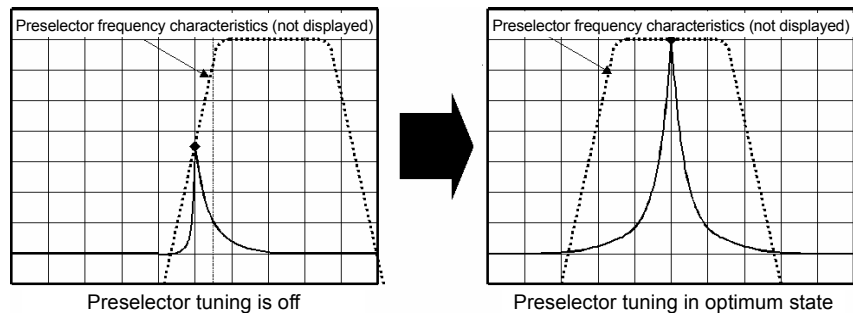

Example: To execute the preselector tuning function automatically

<Procedure>

1. Press **F6** (Accessory) from page 2 of the main function menu, and then press **F7** (Preselector).
2. Press **F1** (Preselector Auto Tune).

Example: To execute the preselector tuning function manually

<Procedure>

1. Press **F6** (Accessory) from page 2 of the main function menu, and then press **F7** (Preselector).
2. Press **F2** (Manual) and use the rotary knob or the cursor keys to display the maximum signal level.
3. To return the setting to the factory default, press **F3** (Preselector Tune Preset).

Chapter 7 *Measure Function*

This chapter describes the Measure function of the Spectrum Analyzer function.

7.1	Selecting Measure Function	7-2
7.2	Adjacent Channel Leakage Power Measurement (ACP)	7-4
7.3	Burst Average Power Measurement.....	7-12
7.4	Channel Power Measurement (Channel Power)	7-15
7.5	Occupied Bandwidth Measurement (Occupied Bandwidth)	7-17
7.6	Spectrum Emission Mask Measurement (Spectrum Emission Mask)	7-20
7.7	Spurious Emission Measurement.....	7-31
7.8	Two-tone Third Order Intermodulation Distortion	7-48

7.1 Selecting Measure Function

Pressing **F2** (Measure) on page 2 of the main function menu, or pressing **Measure** displays the Measure function menu.





Figure 7.1-1 Measure key



Figure 7.1-2 Measure function menu

Table 7.1-1 Measure function menu

Menu Display	Function
Page 1	Measure
ACP	Measures the leakage power of the adjacent channels.
Channel Power	Measures a power of the specified Frequency Band. Sets channel center frequency, channel bandwidth, and filter.
OBW	Measures Occupied bandwidth. Sets dB value by Method, % power of N% method, and X dB method.
Burst Average Power	Measures the average power within a burst.
Spectrum Emission Mask	Executes the Spectrum Emission Mask measurement. Sets the frequency domain standard line and judges quality relative to the standard.
Spurious Emission	Executes the Spurious Emission measurement.
Page 2	Measure
TOI	Measured the two-tone third order intermodulation distortion  7.8 Two-tone third order intermodulation distortion
Standard	Automatically sets the parameters according to the communication method, through specification of the input signal communication method. When the function menu of a measure function is entered when other than OFF is selected, the parameters are loaded automatically according to the communication method. Automatic parameter setting is not done.  Appendix C "Standard Parameter List"

7.2 Adjacent Channel Leakage Power Measurement (ACP)

Pressing **F1** (ACP) on the Measure function menu displays the ACP function menu.

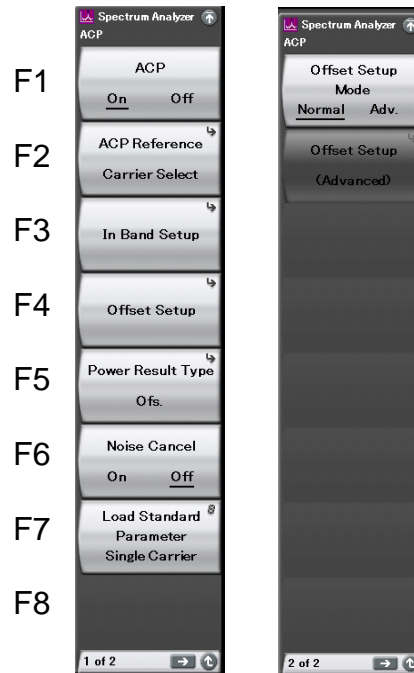



Figure 7.2-1 ACP function menu

7.2 Adjacent Channel Leakage Power Measurement (ACP)

Table 7.2-1 ACP function menu

Menu Display	Function
ACP (On/Off)	The other Measure functions are set to off when ACP is set to On.
ACP Reference	<p>Sets the reference power.</p> <p>Span Total: Uses the integral power on the entire screen as a reference.</p> <p>Carrier Total: Uses the total value of all carrier power as a reference.</p> <p>Both Sides of Carriers: The carrier power of the largest carrier number is used as a reference for the upper offset, while the carrier power of the smallest carrier number is used as reference.</p> <p>Carrier Select: Carrier number used as a reference when the reference of the relative level display for Adjacent Channel Power measurement is set to Carrier.</p>
In Band Setup	Configures settings for In Band.
Offset Setup	Configures settings for the Offset Channel. Use when Offset Setup Mode is Normal.
Power Result Type (Carrier/Ofs/all.)	Switches the power result display. Carrier power is displayed when Carrier is selected, Offset Channel power is displayed when Ofs. is selected and both Carrier power and Offset Channel power are displayed when All is selected.
Noise Cancel (On/Off)	<p>Sets the noise canceling function On/Off.</p> <p>Measures the internal noise of this instrument and deducts the noise from the measurement result, when executed.</p> <p>This function is available only when Standard Parameter is set.</p> <p>Note: The internal noise may not be measured properly when the internal signal is high.</p>
Load Standard Parameter	<p>When “Standard” is set to other than “Off,” the measurement parameters are read according to the selected communication method.</p> <p> Appendix C “Standard Parameter List”</p>
Offset Setup Mode	<p>Set either the Normal or Adv. mode with different Offset setting contents.</p> <p>When Adv. is selected, the measurement results graph display changes because the settable Offset increases.</p>
Offset Setup (Advanced)	<p>This performs Offset Channel related settings.</p> <p>It can be used when the Offset Setup Mode is Adv.</p>

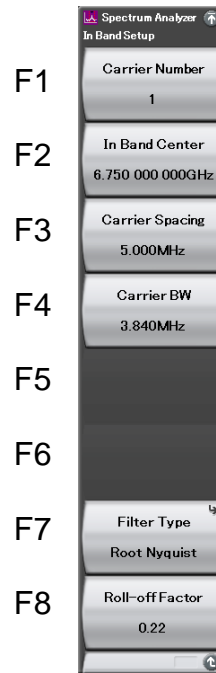



Figure 7.2-2 In Band Setup function menu

Table 7.2-2 In Band Setup function menu

Menu Display	Function
Carrier Number	Sets the number of carriers.
In Band Center	Sets the center frequency of In Band.
Carrier Spacing	Sets an interval between carriers.
Carrier BW	Sets a bandwidth of a carrier.
Filter Type	Sets a filter type of a carrier. Selects a type from Rect, Nyquist, and Root Nyquist.
Roll-off Factor	Sets a roll-off factor. Available only when Nyquist or Root Nyquist is selected in Filter Type.

7.2 Adjacent Channel Leakage Power Measurement (ACP)

The Offset Setup function menu consists of two pages. Press  to change the page.

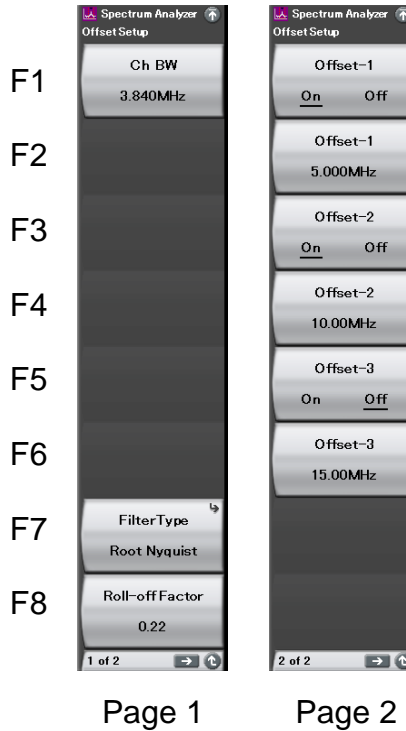

Figure 7.2-3 Offset Setup function menu

Table 7.2-3 Offset Setup function menu

Menu Display	Function
Ch BW	Sets a bandwidth of Offset Channel.
Filter Type	Sets a filter type of Offset Channel. Selects a type from Rect, Nyquist, and Root Nyquist.
Roll-off Factor	Sets a roll-off factor. Available only when Nyquist or Root Nyquist is selected in Filter Type.
Offset-1 (On/Off)	Sets On/Off of Offset Channel 1.
Offset-1	Sets Offset frequency of Offset Channel 1.
Offset-2 (On/Off)	Sets On/Off of Offset Channel 2.
Offset-2	Sets Offset frequency of Offset Channel 2.
Offset-3 (On/Off)	Sets On/Off of Offset Channel 3.
Offset-3	Sets Offset frequency of Offset Channel 3.

The Offset Setup (Advanced) function menu consists of 8 pages that are toggled by pressing .



Figure 7.2-4 Offset Setup (Advanced) function menu

Table 7.2-4 Offset Setup (Advanced) function menu

Menu display	Function
Edit Offset Number	Selects the Offset Number to be edited. 1 through 8 can be selected.
Offset (On/Off)	Enables/disables the selected Offset Channel.
Offset	Sets the offset frequency of selected Offset Channel.
Ch BW	Sets the bandwidth of selected Offset Channel.
Filter Type	Sets the filter type of the selected Offset Channel. Rectangular, Nyquist, Root Nyquist can be selected.
Roll-off Factor	Sets the roll-off factor of the selected Offset Channel. This is available only when Nyquist or Root Nyquist is selected for the Filter Type.

The display items for the measurement results when Power Result Type is set to Offset are described below.

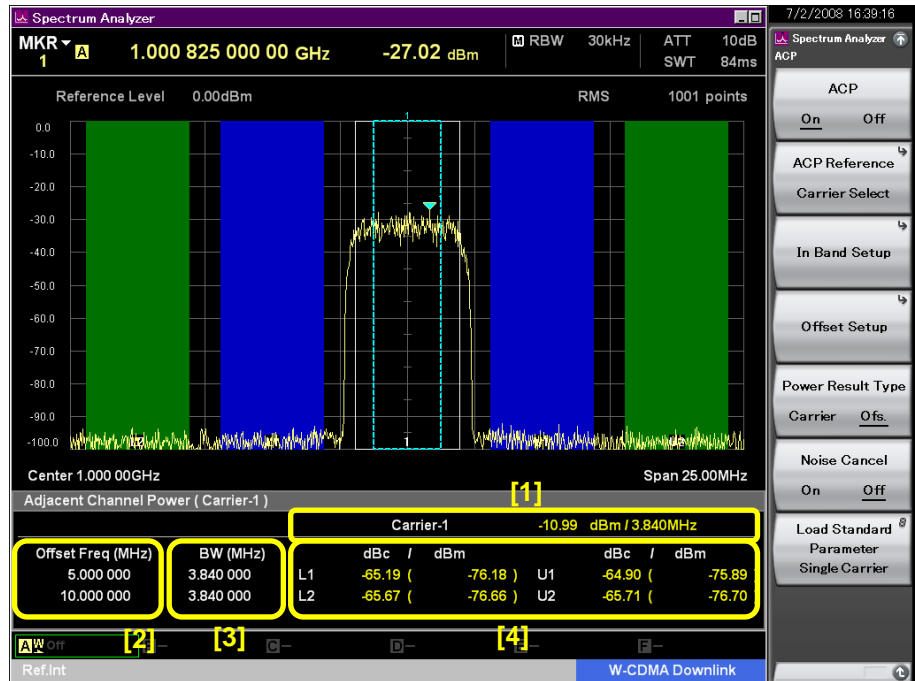

Figure 7.2-5 Display items for measurement result

Table 7.2-5 Display items for measurement result

No.	Display	Description
[1]	Span Total/ Carrier Total Carrier-X/	Displays the integral power in the screen display band when “ACP Reference” is “Span Total,” or the integral power in Carrier when “ACP Reference” is “Carrier Total.” Displays the selected carrier power when “ACP Reference” is “Carrier Select”. Displays the carrier power on both sides when “ACP Reference” is “Both Sides of Carriers”.
[2]	Offset Freq (MHz)	Displays the offset frequency setting value.
[3]	BW (MHz)	Displays the channel bandwidth setting value.
[4]	L1/L2/U1/U2	Displays the power of the Offset Channel bandwidth using Offset-1 to -3 as the center and the relative values in relation to the reference power selected in ACP reference. Also displays in parentheses the absolute power of the Offset channel bandwidth with Offset-1 to -3 as the center.

7.2 Adjacent Channel Leakage Power Measurement (ACP)

The display items for the measurement results when Power Result Type is set to Carrier are described below.

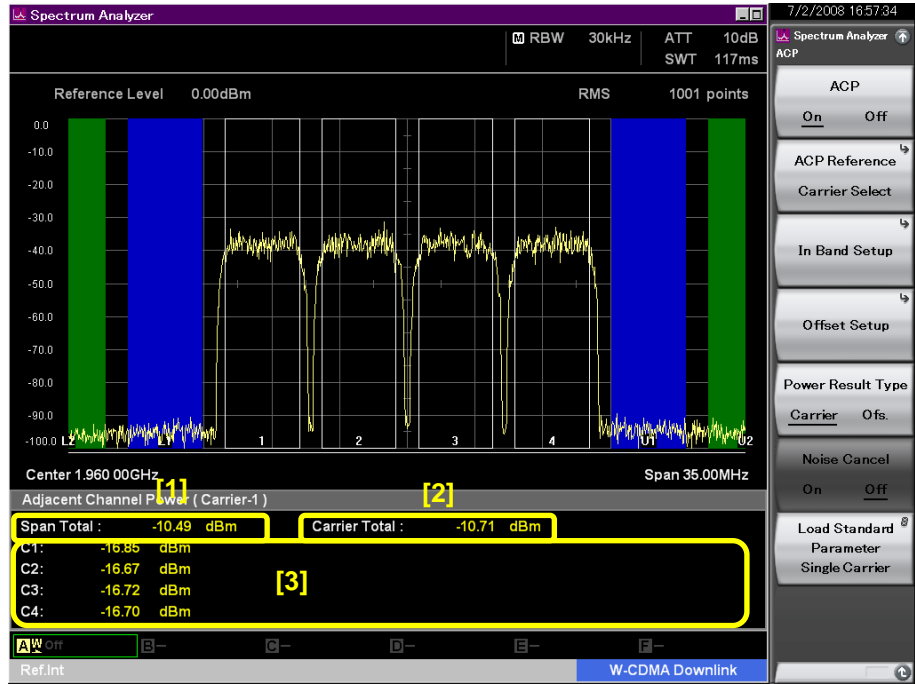

Figure 7.2-6 Display items for the measurement results

Table 7.2-6 Display items for the measurement results

No.	Display	Description
[1]	Span Total	Displays the integral power in the screen display band. Displays the power irrespective of the setting of the ACP reference.
[2]	Carrier Total	Displays the integral power of the carrier set in Carrier Number. Does not display the power when ACP Reference is set to Span Total.
[3]	Cx (x: Carrier Number)	Displays each power of all the carriers set in Carrier Number. Does not display the power when ACP Reference is set to Span Total.

7.3 Burst Average Power Measurement

Pressing **F7** (Burst Average Power) on the Measure function menu displays the Burst Average Power function menu.



Figure 7.3-1 Burst Average Power function menu

Table 7.3-1 Burst Average Power function menu

Menu Display	Function
Burst Average Power (On/Off)	The other Measure functions are set to Off when Burst Average Power is set to On.
Start Time	Sets the start position (time) of the measurement interval.
Stop Time	Sets the stop position (time) of the measurement interval.
Noise Cancel (On/Off)	<p>Sets the noise canceling function On/Off. Measures the internal noise of the MS2690A/MS2691A/MS2692A and deducts the measured noise from the measurement result, when executed.</p> <p>This function is available only when Standard Parameter is set.</p> <p>Note: The internal noise may not be measured properly when the internal signal is high.</p>
Load Standard Parameter	<p>When “Standard” is set to other than Off, the measurement parameters are read according to the communication method selected in Standard.</p> <p> Appendix C “Standard Parameter List”</p>

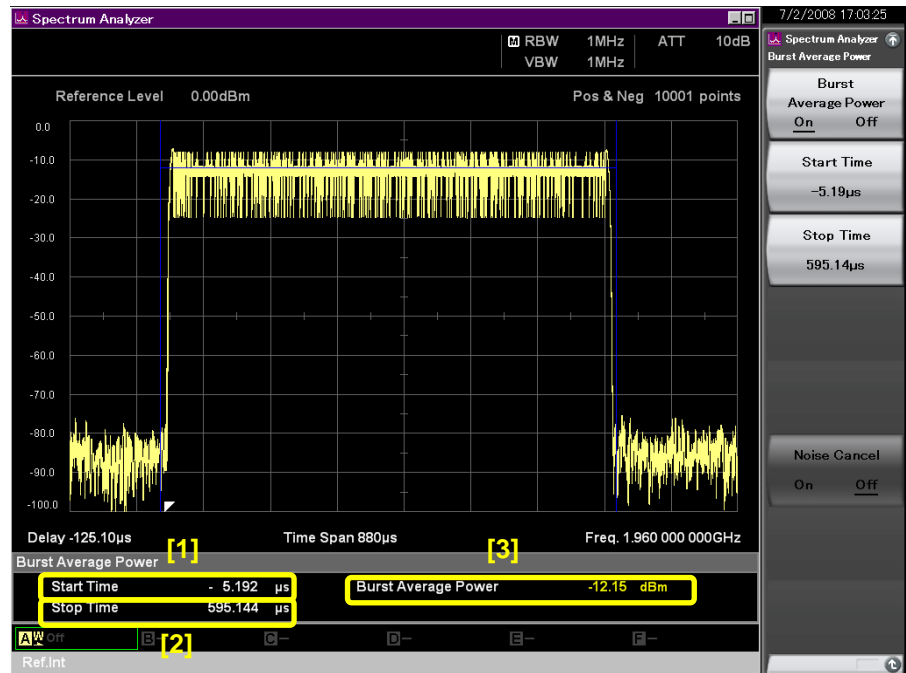

Figure 7.3-2 Display items for measurement result

Table 7.3-2 Display items for measurement result

No.	Display	Description
[1]	Start Time	Displays the start position (time) of the measurement interval.
[2]	Stop Time	Displays the stop position (time) of the measurement interval.
[3]	Burst Average Power	Displays the average power of the interval specified with Start Time and Stop Time.

7.4 Channel Power Measurement (Channel Power)

Press **F2** (Channel Power) on the Measure function menu to display the Channel Power function menu.

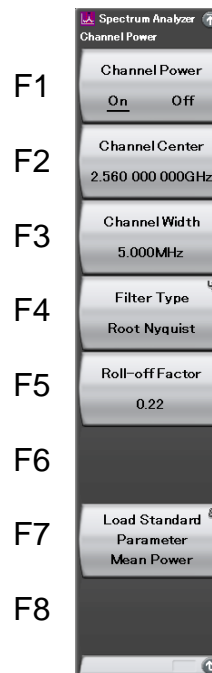

Figure 7.4-1 Channel Power function menu

Table 7.4-1 Channel Power function menu

Menu Display	Function
Channel Power (On/Off)	The other Measure functions are set to Off when Channel Power is set to On.
Channel Center	Sets the channel center frequency.
Channel Width	Sets the channel bandwidth.
Filter Type	Sets a filter type. Selects from Rect., Nyquist, and Root Nyquist.
Roll-off Factor	Sets a roll-off factor. Available only when Nyquist or Root Nyquist is selected in Filter Type.
Load Standard Parameter	When Standard is set to other than Off, the measurement parameters are read according to the communication method selected in Standard. Appendix C "Standard Parameter List"

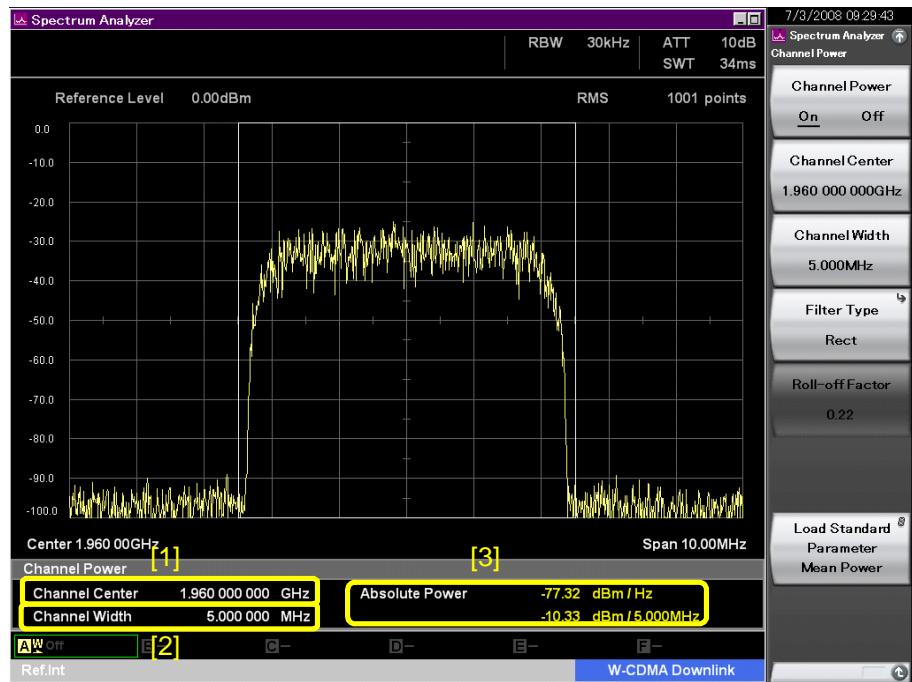

Figure 7.4-2 Display items for measurement results

Table 7.4-2 Display items for measurement results

No.	Display	Description
[1]	Channel Center	Displays the setting value of the channel center frequency.
[2]	Channel Width	Displays the setting value of the channel bandwidth.
[3]	Absolute Power	Displays the absolute power per 1 Hz within the channel band and the integral power within the channel band.

7.5 Occupied Bandwidth Measurement (Occupied Bandwidth)

Press **F3** (Occupied Bandwidth) on the Measure function menu to display the Occupied Bandwidth function menu.

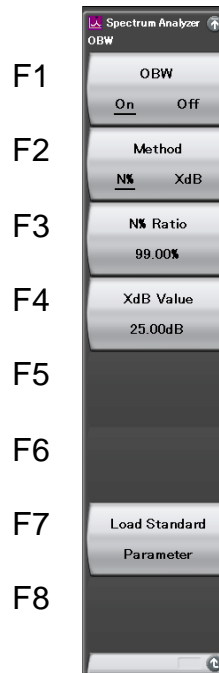



Figure 7.5-1 Occupied Bandwidth function menu

Table 7.5-1 Occupied Bandwidth function menu

Menu Display	Function
OBW (On/Off)	The other Measure functions are set to Off when OBW is set to On.
Method (N%/XdB)	<p>Selects a measurement method. Selects X dB Down mode or N% of Power mode.</p> <ul style="list-style-type: none"> • X dB Down mode OBW is the width between the two points down by X dB from the peak of the trace data. • N% of Power mode The total power of the trace data on the screen is 100%, and OBW is the width between the two points which have power corresponding to N%.
N% Ratio	Enters % power in the N% of Power mode.
XdB Value	Enters dB value in the X dB Down mode.
Load Standard Parameter	<p>When “Standard” is set to other than “Off,” the measurement parameters are read according to the communication method selected in Standard.</p> <p> Appendix C “Standard Parameter List”</p>

7.5 Occupied Bandwidth Measurement (Occupied Bandwidth)

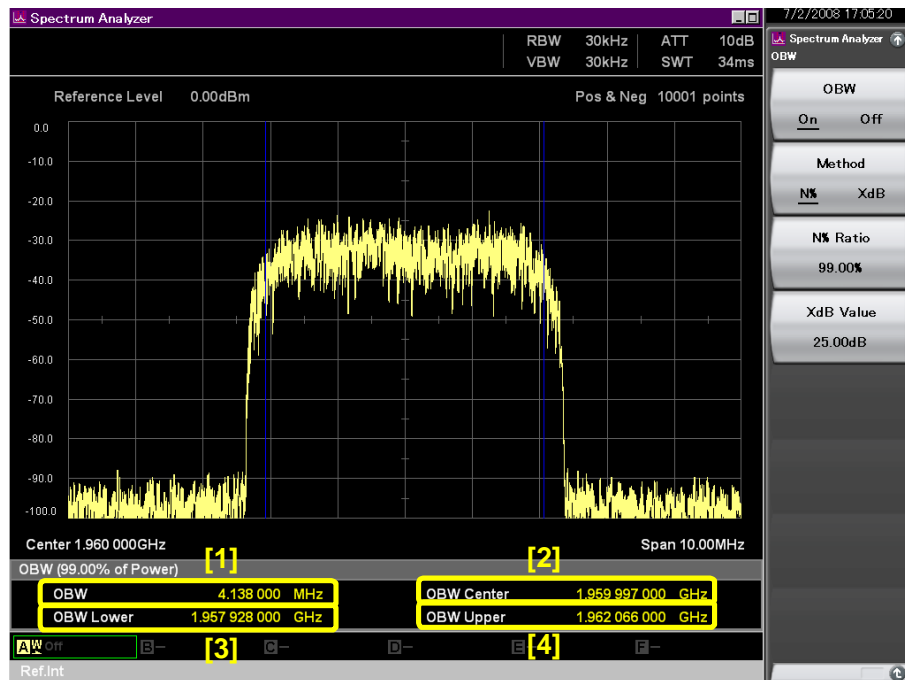



Figure 7.5-2 Display items for measurement results

Table 7.5-2 Display items for measurement results

No.	Display	Description
[1]	OBW	Displays the occupied bandwidth.
[2]	OBW Center	Displays the center frequency of the occupied bandwidth.
[3]	OBW Lower	Displays the frequency on the left of the occupied bandwidth.
[4]	OBW Upper	Displays the frequency on the right of the occupied bandwidth.

7.6 Spectrum Emission Mask Measurement (Spectrum Emission Mask)

On the Measure function menu, pressing  (Spectrum Emission Mask) displays the Spectrum Emission Mask function menu.

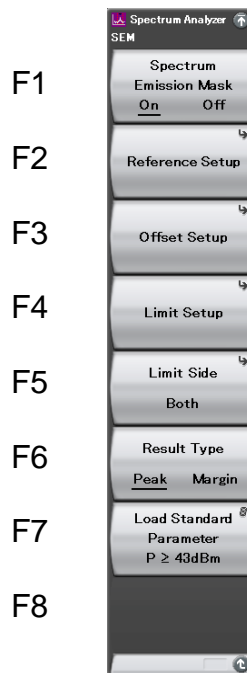





Figure 7.6-1 Spectrum Emission Mask function menu

Table 7.6-1 Spectrum Emission Mask function menu

Menu	Function
Spectrum Emission Mask (On/Off)	The other Measure functions are set to Off when Spectrum Emission Mask is set to On.
Reference Setup	Sets the reference carrier.
Offset Setup	Sets the offset.
Limit Setup	Sets the limit line.
Limit Side	<p>Selects the side of the limit line to judge.</p> <p>Both Makes a judgment on both sides.</p> <p>Lower Makes a judgment only in a frequency lower than the reference.</p> <p>Upper Makes a judgment in a frequency higher than the reference.</p> <p>The measurement result is initialized (“***” is displayed in Result) when this parameter is changed while measurement stops. At this time, the limit line is not displayed at the set position because the limit line refers to the measurement result. In order to update the limit line, press  to perform measurement again.</p>
Result Type	<p>Switches the display of the level result for each offset.</p> <p>Peak Displays with the absolute power.</p> <p>Margin Displays with the relative power of the reference line and measurement value.</p>
Load Standard Parameter	<p>When Standard is set to other than Off, loads the measurement parameter according to the communication method selected in Standard.</p> <p> Appendix C “Standard Parameter List”</p>

The Reference Setup function menu consists of three pages. Press  to change the page.

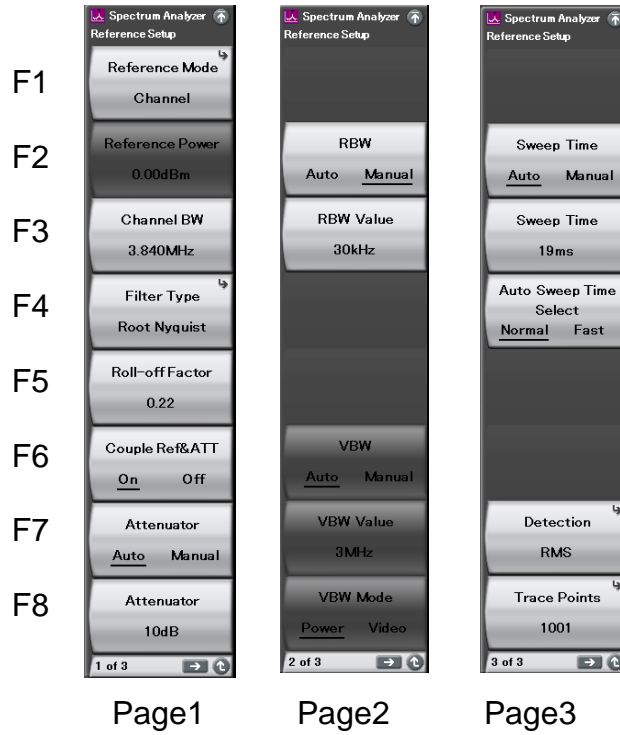



Figure 7.6-2 Reference Setup function menu

Table 7.6-2 Reference Setup function menu

Menu	Function
Reference Mode	<p>Selects how to calculate the reference power.</p> <p>Channel Uses the integral power within the range set in Channel BW for reference.</p> <p>Peak Uses the peak power within the range set in Channel BW for reference.</p> <p>Fix Uses the value set in Reference Power for reference.</p>
Reference Power	Sets the reference power when Reference Mode is set to Fix.
Channel BW	Sets the bandwidth when measuring the reference power.
Filter Type	Sets the filter type when measuring the reference power. Selects a type from Rect, Nyquist, and Root nyquist.
Roll-off Factor	Sets the roll-off factor. Valid only when Filter Type is set to Nyquist or Root nyquist.
Couple Ref & ATT	Setting here for Reference Level and Attenuator is shared in Offset Setup.
Attenuator Auto/Manual	Switches auto/manual setting of attenuator when measuring the reference power.
Attenuator	Sets the attenuator when measuring the reference power.
RBW Auto/Manual	Switches auto/manual setting of RBW when measuring the reference power.
RBW Value	Sets RBW when measuring the reference power.
VBW Auto/Manual	Switches auto/manual setting of VBW when measuring the reference power.
VBW Value	Sets VBW when measuring the reference power.
VBW Mode	Sets a VBW type when measuring the reference power.
Sweep Time Auto/Manual	Switches auto/manual setting of Sweep Time when measuring the reference power.
Sweep Time	Sets Sweep Time when measuring the reference power.
Auto Sweep Time Select	Selects a setting method when Sweep Time is set to Auto.
Detection	Sets a detection method when measuring the reference power.
Trace Points	Sets the trace point when measuring the reference power.

The Offset Setup function menu consists of four pages. Press  to change the page.

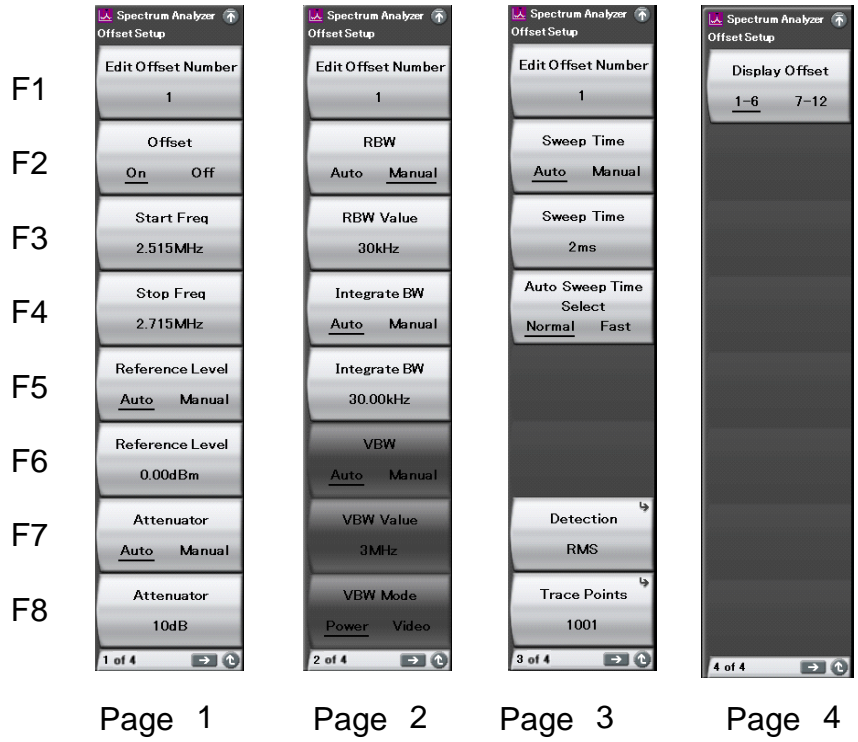



Figure 7.6-3 Offset Setup function menu

Table 7.6-3 Offset Setup function menu

Menu	Function
Edit Offset Number	Selects Offset to be set.
Offset On/Off	Sets On/Off of Offset.
Start Freq	Sets the start frequency of Offset. Sets the offset value from Center Freq.
Stop Freq	Sets the stop frequency of Offset. Sets the offset value from Center Freq.
Reference Level Auto/Manual	Selects Auto/Manual of the reference level. When Auto is selected, it will be the same value as the reference level when measuring the reference power.
Reference Level	Sets the reference level when measuring the offset.
Attenuator Auto/Manual	Switches Auto/Manual setting of the attenuator when measuring Offset.
Attenuator	Sets the attenuator when measuring Offset.
RBW Auto/Manual	Switches Auto/Manual setting of RBW when measuring Offset.
RBW Value	Sets RBW when measuring Offset.
Integrate BW Auto/Manual	Sets the resolution bandwidth when creating the trace data. It will be the same value as RBW, when Auto is selected.
Integrate BW	<p>Sets the measurement bandwidth to integrate the trace data swept by the specified RBW. This function has the following features.</p> <p>Able to perform a measurement with a resolution band width other than the selectable RBW.</p> <p>Able to gain a better selectivity in order to realize the specified band width by a small RBW.</p>
VBW Auto/Manual	Switches auto/manual setting of VBW when measuring Offset.
VBW Value	Sets VBW when measuring Offset.
VBW Mode	Sets the type of VBW when measuring Offset.
Sweep Time Auto/Manual	Switches auto/manual setting of Sweep Time when measuring Offset.
Sweep Time	Sets Sweep Time when measuring Offset.
Auto Sweep Time Select	Selects the setting method when Sweep Time is set to Auto.
Detection	Sets the detection type when measuring Offset.
Trace Points	Sets the trace point when measuring Offset.
Display Offset	<p>Selects the offset to be displayed on screen.</p> <ul style="list-style-type: none"> • 1-6: Displays offset 1 to 6. • 7-12: Displays offset 7 to 12.

On the Spectrum Emission Mask function menu, pressing  (Limit Setup) displays the Limit Setup function menu.

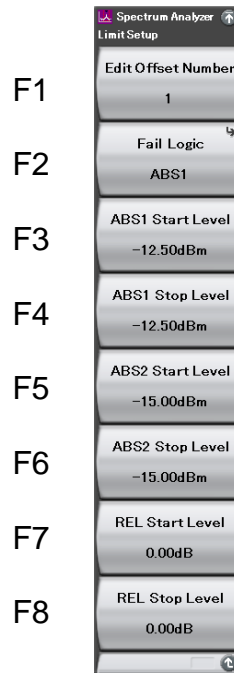

Figure 7.6-4 Limit Setup function menu

Table 7.6-4 Limit Setup function menu

Menu	Function
Edit Offset Number	Selects the offset to be set.
Fail Logic	<p>Specifies how to judge Pass/Fail.</p> <p>ABS1 Executes a judgment with the absolute level upper 1.</p> <p>REL Executes a judgment with the relative level upper.</p> <p>ABS1 and REL Executes “AND judgment” with the absolute level upper 1 and relative level upper.</p> <p>ABS1 or REL Executes “OR judgment” with the absolute level upper 1 and the relative level upper.</p> <p>ABS1 and ABS2 Executes “AND judgment” with the absolute level upper 1 and the absolute level upper 2.</p> <p>(ABS1 and REL) and ABS2 Executes “AND judgment” with the absolute level upper 1 and the relative level upper.</p> <p>Executes “AND judgment” with the result and the absolute level upper 2.</p> <p>(ABS1 or REL) and ABS2 Executes “OR judgment” with the absolute level upper 1 and the relative level upper. Executes “AND judgment” with the result and the absolute level upper 2.</p> <p>Off Does not judge.</p> <p>“AND judgment” is a method to put the two reference lines together and judge the lower level as the reference line. “OR judgment” is a method to combine the two reference lines and judge the higher level as being the reference line.</p>
ABS1 Start Level	Sets the absolute level upper limit 1 of the offset start frequency.
ABS1 Stop Level	Sets the absolute level upper limit 1 of the offset stop frequency.
ABS2 Start Level	Sets the absolute level upper limit 2 of the offset start frequency.
ABS2 Stop Level	Sets the absolute level upper limit 2 of the offset stop frequency.
REL Start Level	Sets the relative level upper limit of the offset start frequency.
REL Stop Level	Sets the relative level upper limit of the offset stop frequency.

The display items for the measurement results are described below.

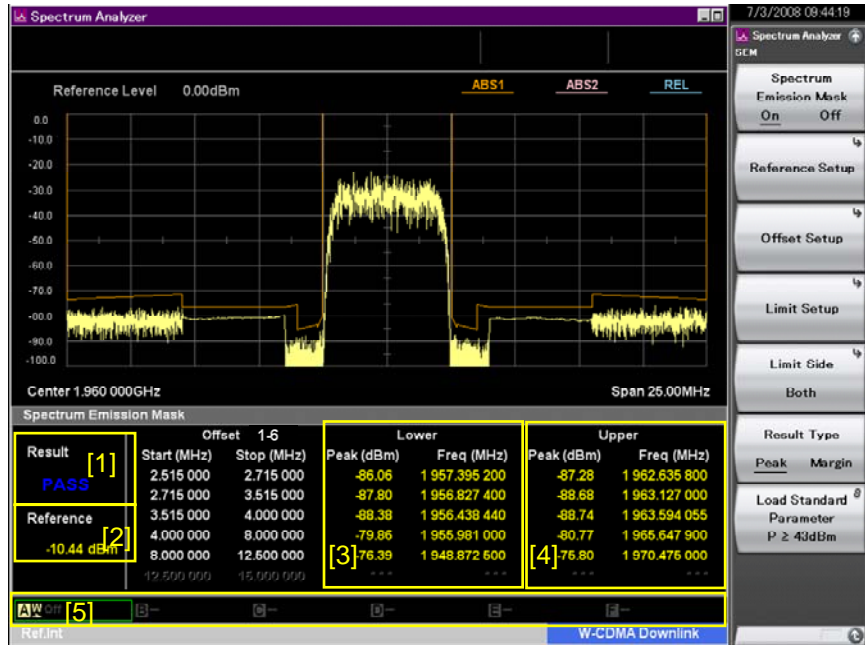



Figure 7.6-5 Display items for Measurement results

Table 7.6-5 Display items for measurement results

No.	Display	Description
[1]	Result	Displays the result of Pass/Fail judgment. "PASS" is displayed, if all the results are Pass. If not, "FAIL" will be displayed.
[2]	Reference	Displays the reference power.
[3]	Lower	Displays the result of the offset on the left of the reference. When the limit line is set, displays the frequency in which (limit line - measurement value) is the smallest. When Result Type is set to Peak, displays the level (measurement value), and when it is set to Margin, displays the margin (limit line minus measurement value).
[4]	Upper	Displays the result of the offset on the right of the reference. When the limit line is set, displays the frequency in which (limit line - measurement value) is the smallest. When Result Type is set to Peak, displays the level (measurement value), and when it is set to Margin, displays the margin (limit line minus measurement value).

7.6 Spectrum Emission Mask Measurement (Spectrum Emission Mask)

Table 7.6-5 Display items for measurement results (Cont'd)

[5]	Trace parameter	Displays storage mode, storage times, and trace type writing mode. Displays storage times in % for Spectrum Emission Mask  3.1.2 Averaging function
-----	-----------------	--

The measurement result is initialized (***) is displayed in Result) when a parameter that requires recapture is changed while measurement stops. At this time, the limit line is not displayed at the set position because the limit line refers to the measurement result. In order to update the limit line, press  to perform measurement again.

When Integrate BW (IBW) is set to Manual, the data measured by RBW, Sweep Time, Detection, and Trace Point set in the Offset menu is integrated by the width of IBW. Therefore, although the result is displayed in the range from Start Freq to Stop Freq on the screen, the actual sweep is performed in the range from Start Freq - IBW/2 to Stop Freq + IBW/2.

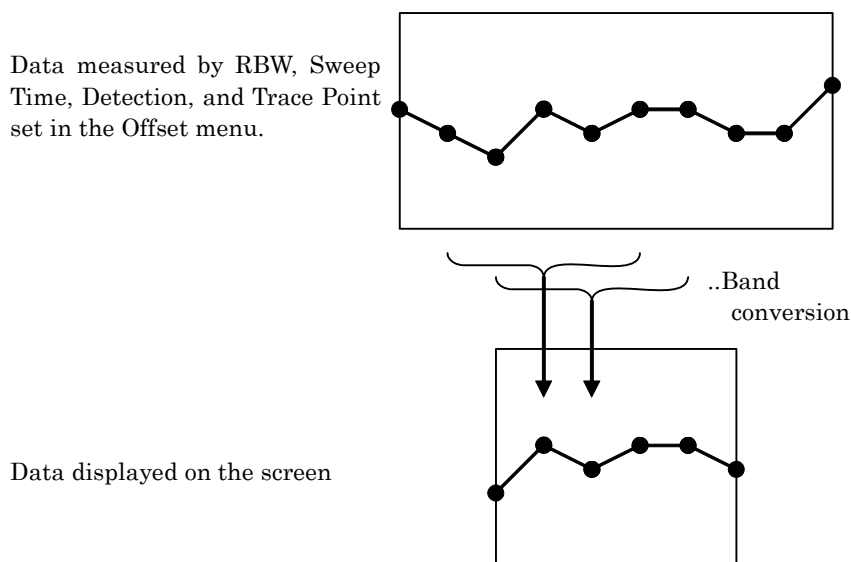

Figure 7.6-6 Band conversion (IBW)

An error occurs between the IBW setting value and the actual integral width, according to the frequency resolution of trace point. The error (Error [Hz]) is calculated by the following formula:

$$|Error| \leq \frac{StopFreq - StartFreq}{\left\{ OddF \left(TracePoint \cdot \frac{StopFreq - StartFreq}{IBW + (StopFreq - StartFreq)} \right) \right\} - 1}$$

Note that OddF(x) indicates a function to return the biggest odd number of a figure, the number being no greater than x.

You can decrease the error of IBW by increasing Trace Point. For example, in Start Freq = 4 MHz, Stop Freq = 8 MHz, Trace Point = 1001, IBW = 1 MHz, the error (Error [Hz]) of IBW is:

$$|Error| \leq 5013 \text{ [Hz]}$$

If Trace Point is 10001:

$$|Error| \leq 501 \text{ [Hz]}$$

Furthermore, when measuring a line spectrum, set IBW to greater than or equal to 3×RBW to reduce errors due to the type of RBW.

7.7 Spurious Emission Measurement

Once Spurious Emission measurement has been executed, the segments set in Segment Setup are swept. After the measurement has finished, the result is displayed. Furthermore, the spurious detected by the limit line set in each segment is judged as Pass/Fail.

Pressing **F5** (Spurious Emission) on the Measure function menu displays the Spurious Emission function menu. The Spurious Emission function menu consists of 3 pages. Pressing **F5** switches the pages.

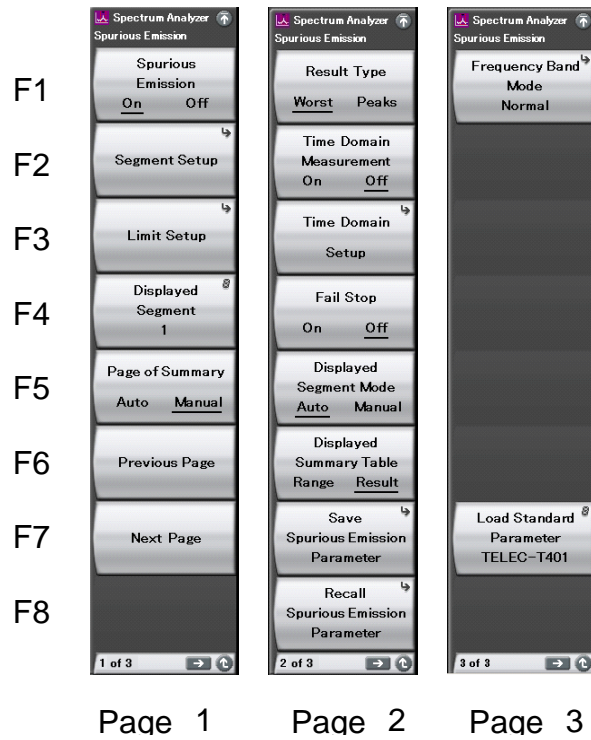



Figure 7.7-1 Spurious Emission Function Menu

Table 7.7-1 Description of Spurious Emission Function Menu

Menu Display	Function
Spurious Emission (On/Off)	When set to On, the other Measure functions are set to Off.
Segment Setup	Sets the segment to sweep.
Limit Setup	Sets the limit line.
Displayed Segment	Sets the number of the segment to display on the trace. Unable to set any segment which is set to Off in Segment Setup.
Page of Summary (Auto/Manual)	Sets the summary page auto numbering to Auto/Manual. Auto mode makes it possible to display the page on which the segment set in Displayed Segment is. This is available when Displayed Summary Table is set to Result .
Previous Page	Displays the summary on the previous page.
Next Page	Displays the summary on the next page.
Result Type (Worst/Peaks)	Selects the mode to display the spurious detected in each segment. Worst: Displays the spurious with the least margin to the limit line set in Limit Setup. Peaks: Displays the spurious detected by Search Resolution and Search Threshold set in each segment. Up to 10 segments are displayed per one segment.
Time Domain Measurement (On/Off)	Sets whether to execute the time domain main measurement for spurious power. When set to On, the setting of Result Type is fixed to Worst.
Time Domain Setup	Configures the settings for Time Domain measurement.
Fail Stop (On/Off)	When set to On, the measurement stops as soon as the spurious over the limit line has been detected.
Displayed Segment Mode (Auto/Manual)	Sets Displayed Segment Mode to Auto/Manual. When set to Auto, the setting of Displayed Segment is automatically switched in order to display the segment which is being swept.
Displayed Summary Table	Selects the contents displayed for Summary Table. <ul style="list-style-type: none"> • Result Displays measurement result. • Range Displays frequency range, RBW setting and VBW setting for each segment.

Table 7.7-1 Description of Spurious Emission Function Menu (Cont'd)

Menu Display	Function
Save Spurious Emission Parameter	Saves the parameters of Spurious Emission measurement. Register 1 to 8 are available to save the parameters. The date and time when the parameters were saved are displayed with a parameter which contains the parameter. *** is displayed with the register which does not contain the parameter.
Recall Spurious Emission Parameter	Queries the parameter for Spurious Emission measurement. Register 1 to 8 are available to save the parameters. The date and time when the parameters were saved are displayed with the parameter which contains the parameter. *** is displayed with the register which does not contain the parameter.
Frequency Band Mode	Displays the Frequency Band Mode menu.  2.3.6 “Changing frequency band”
Load Standard Parameter	When “Standard” is set to other than “Off,” the measurement parameters are read according to the selected communication method. This menu will not be displayed if parameter without Spurious Emission function is selected for Standard.  Appendix C “Standard Parameter List”

The parameters for Save Spurious Emission Parameter and Recall Spurious Emission Parameter are shown below:

Table 7.7-2 Parameters to save/query

Parameter
All the parameters (except Spurious Emission On/Off) on Spurious Emission menu
Frequency Offset On/Off
Frequency Offset Value
Reference Level Offset On/Off
Reference Level Offset Value
Frequency Band Mode
Trigger Switch
Trigger Source
Trigger Slope
Trigger Level (Video)
Trigger Level (Wide IF Video)
Gate Sweep On/Off
Gate Delay
Gate Length
Gate Source

Table 7.7-2 Parameters to save/query (Cont'd)

Parameter
Gate Slope
Gate Level (Wide IF Video)
VBW Mode
Auto Sweep Time Select
Storage Mode

Pressing **F2** (Segment Setup) on page 1 of the Spurious Emission function menu displays the Segment Setup function menu. Segment Setup function menu consists of three pages. Press **→** to switch the page.

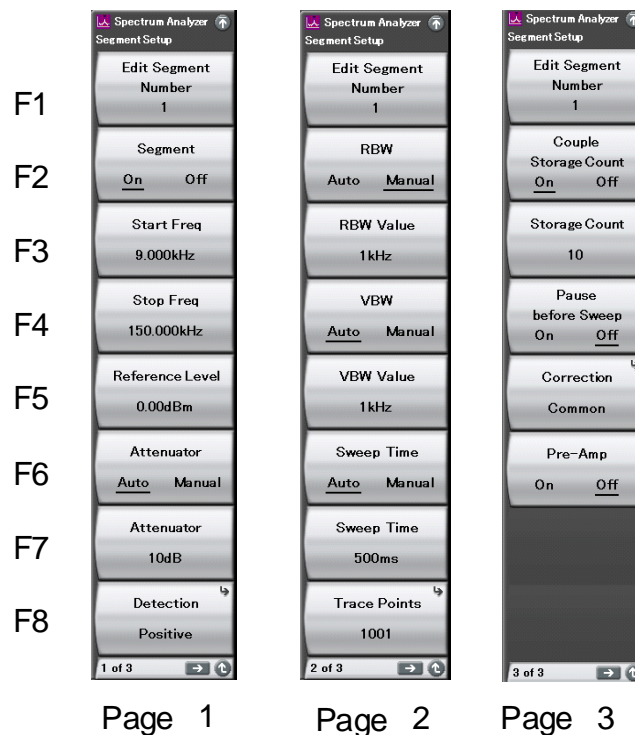

Figure 7.7-2 Segment Setup function menu

Table 7.7-3 Descriptions of Segment Setup function menu

Menu Display	Function
Edit Segment Number	Sets the segment number.
Segment	Sets the segment to On/Off.
Start Freq	Sets the start frequency.
Stop Freq	Sets the stop frequency.
Reference Level	Sets the reference level.
Attenuator (Auto/Manual)	Sets Auto/Manual for the attenuator.
Attenuator	Sets the attenuator value.
Detection	Sets the detection mode.
RBW (Auto/Manual)	Sets RBW to Auto/Manual.
RBW Value	Sets RBW value.
VBW (Auto/Manual)	Sets Auto/Manual for VBW of a segment. The setting of VBW Mode on BW function menu applies to all the segments.
VBW Value	Sets the video bandwidth. This function is invalid when the detection mode of a segment is set to RMS.
Sweep Time (Auto/Manual)	Sets Auto/Manual for the sweep time of a segment. The setting of Auto Sweep Time Select on Time/Sweep function menu applies to all the segments.
Sweep Time	Sets the sweep time.
Trace Points	Sets the trace points.
Couple Storage Count (On/Off)	Sets the shared setting of the storage count in each segment to On/Off. When set to On, the same as the storage count of the segment set in Displayed segment is set to those of all other segments.
Storage Count	Sets the storage count of a segment.
Pause before Sweep (On/Off)	Configures settings to pause before sweep of each segment. When it is set to On, the dialog box is displayed before measuring the segment, and the measurement pauses.
Correction	Sets the correction table to use in a segment.
Pre-Amp (On/Off)	Sets Pre Amp to On/Off.

Pressing **F5** (Correction) on page 7.7-2 of the Segment Setup function menu displays the Correction function menu.

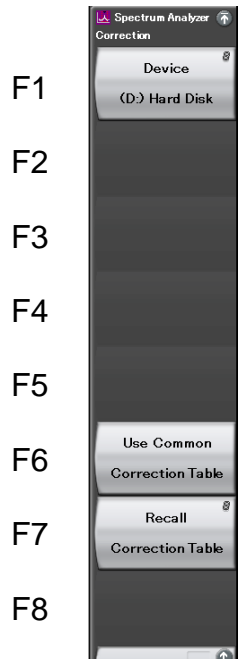

Figure 7.7-3 Correction function menu

Table 7.7-4 Descriptions of Correction function menu

Menu Display	Function
Device	Selects the drive.
Use Common Correction Table	Uses the common correction table.
Recall Correction Table	Selects the level frequency correction table used in the set segment by specifying a file.

For details of a correction table, see “3.4.10 Correction” of MS2690A/MS2691A/MS2692A Signal Analyzer Operation Manual (Main unit Operation).

Pressing **F3** (Limit Setup) on page 1 of the Spurious Emission function menu displays the Limit Setup function menu.

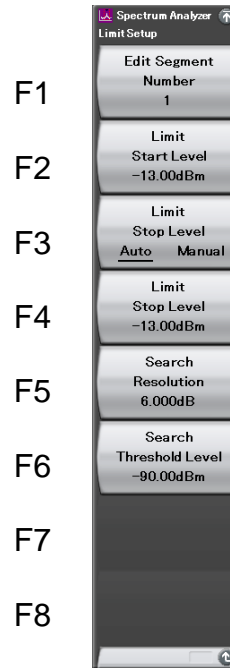



Figure 7.7-4 Limit Setup function menu

Table 7.7-5 Descriptions of Limit Setup function menu

Menu Display	Function
Edit Segment Number	Sets the segment.
Limit Start Level	Sets the absolute limit level of the start frequency in the segment.
Limit Stop Level (Auto/Manual)	Sets the absolute level limit of the stop frequency in the segment to Auto/Manual. When set to Auto, the same as the value set in Limit Start Level is set to Limit Stop Level.
Limit Stop Level	Sets the absolute level limit of the stop frequency in the segment.
Search Resolution	Sets the spurious search resolution when Result Type is set to Peaks.
Search Threshold Level	Sets the spurious search threshold when Result Type is Peaks.

Pressing  (Time Domain Setup) on page 2 of the Spurious Emission function menu displays the Time Domain Setup function menu.

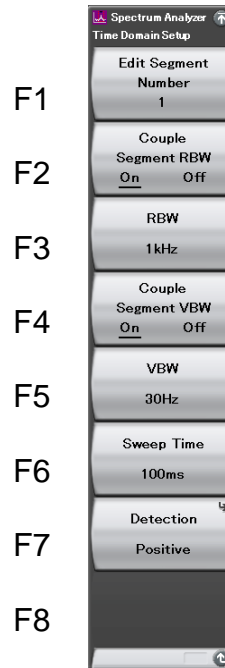
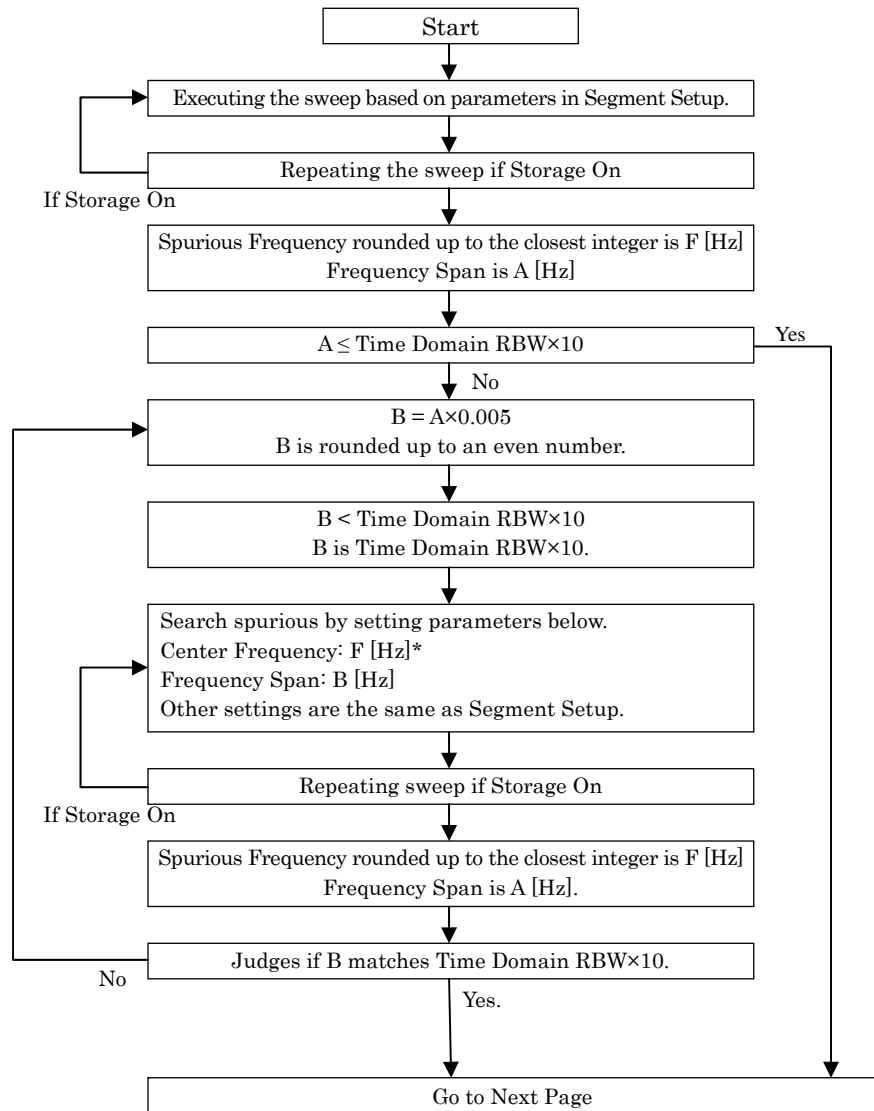

Figure 7.7-5 Time Domain Setup function menu

Table 7.7-6 Descriptions of Time Domain Setup function menu

Menu Display	Function
Edit Segment Number	Sets the segment.
Couple Segment RBW (On/Off)	Sets whether to share the RBW value set in Time Domain Setup. When set to On, the same as the value set in Segment Setup is automatically set to RBW value in Time Domain Setup.
RBW	Sets the RBW value set in Time Domain Setup.
Couple Segment VBW (On/Off)	Sets whether to share the VBW value set in Time Domain Setup. When set to On, the same as the value set in Segment Setup is automatically set to VBW value in Time Domain Setup. This function is invalid when the detection mode in Time Domain Setup is set to RMS.
VBW	Sets the VBW value set in Time Domain Setup. This function is invalid when the detection mode in Time Domain Setup is set to RMS.
Sweep Time	Sets the sweep time in Time Domain mode.
Detection	<p>Sets the detection mode of Time Domain measurement. The setting of Storage Mode on Trace function menu applies to all the segments.</p> <p>When Detection is set to Positive, the maximum value (peak power) is detected. When Storage Mode is set to other than Off, Storage Mode is set to Max Hold during Time Domain measurement.</p> <p>When Detection is set to RMS or Sample, the average power is detected. When Storage Mode is set to other than Off, it is set to Lin Average during Time Domain measurement.</p>

When Time Domain Measurement is set to On, Time Domain measurement is executed, as Figure 7.7-6 shows.



*: The sweep may go outside the Start Freq. and Stop Freq. range of the target segment, depending on B values. To prevent the problem, F is selected as below.
 If $F + (B/2)$ is above Stop Freq. of the target segment:
 $F = (\text{Stop Freq.}) - (B/2)$
 If $F - (B/2)$ is below Stop Freq. of the target segment:
 $F = (\text{Start Freq.}) + (B/2)$

Figure 7.7-6 Measurement Sequence of Time Domain measurement

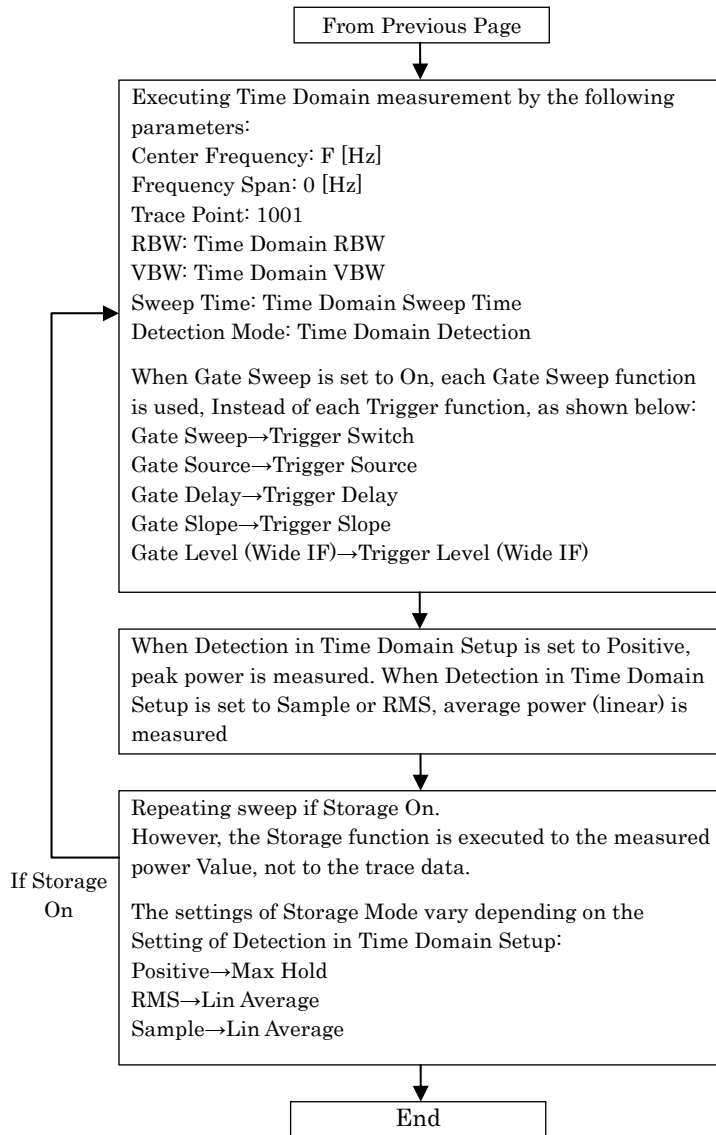

Figure 7.7-6 Measurement Sequence of Time Domain measurement (Cont'd)

Pressing **F6** (Trace) on the main function menu or **Trace** displays the Trace function menu.

During Spurious Emission measurement, the Trace function menu changes, as shown below:

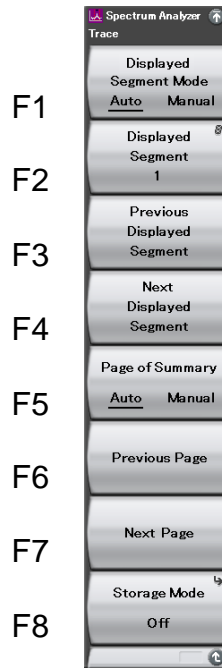

Figure 7.7-7 Trace function menu

Table 7.7-7 Descriptions of Trace function menu

Menu Display	Function
Displayed Segment Mode (Auto/Manual)	Sets Displayed Segment Mode to Auto/Manual. When set to Auto, the setting of Displayed Segment is automatically switched to display the segment which is being swept.
Displayed Segment	Sets the segment to display on the trace. A segment which is set to Off cannot be selected. This command cannot be set during measurement and when Displayed Segment Mode is set to Auto.
Previous Displayed Segment	Displays the previous segment on the trace. If this function is executed when the trace displays the segment which is set to On and whose number is the smallest, the trace displays the segment which is set to On and whose number is the biggest. This function is invalid during measurement and when Displayed Segment Mode is set to Auto.
Next Displayed Segment	Displays the next segment on the trace. If this function is executed when the trace displays the segment which is set to On and whose number is the biggest, the trace displays the segment which is set to On and whose number is the smallest. This function is invalid during measurement and when Displayed Segment Mode is set to Auto.
Page of Summary (Auto/Manual)	Turns on/off the summary page auto numbering. Auto mode makes it possible to display the page on which the segment set in Displayed Segment is. This is available when Displayed Summary Table is set to Result.
Previous Page	Displays the summary on the previous page.
Next Page	Displays the summary on the next page.
Storage Mode	Configures the settings to update/display the trace data. For details, see “3.1 Setting Storage Mode”.

Display items of the measurement results are described below:

When Result Type is set to Worst, the summary page displays the spurious with the least margin from the limit line set in Limit Setup.



Figure 7.7-8 Display items of Spurious Emission measurement result (When Result Type is set to Worst.)

Table 7.7-8 Descriptions of Display Items for Spurious Emission measurement results

No.	Item	Description
[1]	---	Displays the trace of the segment.
[2]	No, Segment, Frequency, Peak, Margin, Limit	Displays the summary page. Five measurement results are displayed per one page. One page displays the following result: No: Spurious number Segment: Segment number of the detected spurious Frequency: Frequency of the detected spurious (Hz) Peak: Power of the detected spurious (dBm) Margin: Difference between the detected spurious and the limit line (limit line minus measurement value) (dB) Limit: Value of limit line to the frequency of the detected spurious (dBm)
[3]	Result	Displays the result (Pass/Fail). Pass is displayed if all the segments are judged as Pass. If not, Fail is displayed.
[4]	Peaks/Worst	Displays the setting of Result Type.
[5]	---	A marker is displayed with the detected marker. The figure of the marker is the spurious number.

Switch Time Domain to On while the measurement is being stopped, or change the limit line after executing the measurement when Time Domain is set to On. Then the remeasurement message, "Please sweep again.", is displayed. Execute the measurement (Single) again, in order to display the result of Time Domain measurement.

Note:

When **Displayed Summary Table** is set to **Range**, the summary displays frequency range, RBW setting and VBW setting for each segment.

When Result Type is set to Peaks, the spurious detected by Search Resolution and Search Threshold set in each segment is displayed on the summary page. Up to 10 spurious can be displayed per one segment.

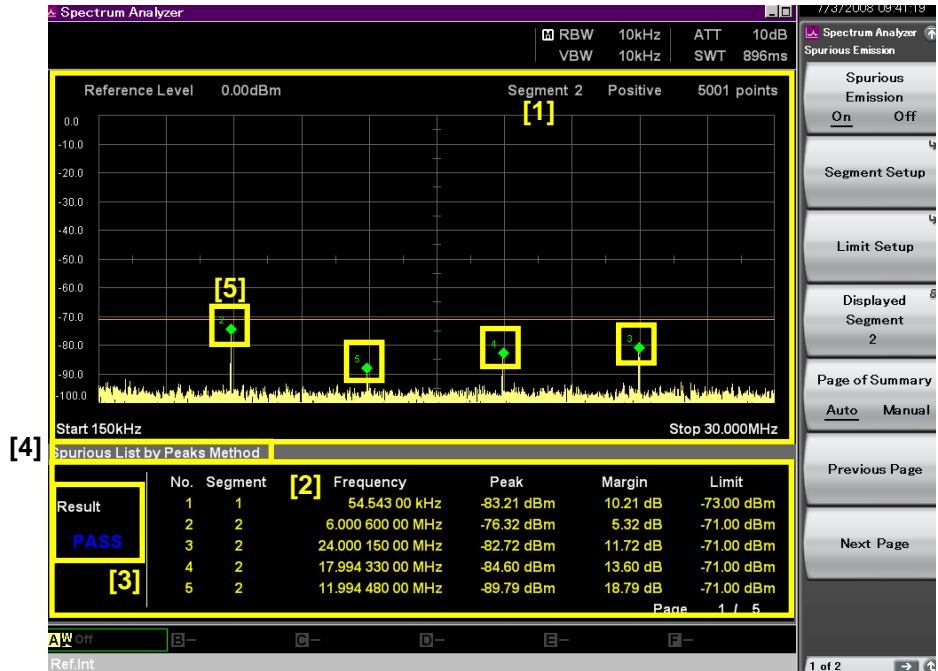

Figure 7.7-9 Display items of Spurious Emission measurement result (When Result Type is set to Peaks)

Table 7.7-9 Descriptions of Spurious Emission display items

No.	Item	Description
[1]	---	Displays the trace of the segment.
[2]	No, Segment, Frequency, Peak, Margin, Limit	Displays the summary page. Five measurement results are displayed per one page. Up to 10 spurious can be displayed per one segment. Each page displays the following result: No: Spurious number Segment: Segment number of the detected spurious Frequency: Frequency of the detected spurious (Hz) Peak: Power of the detected spurious (dBm) Margin: Difference between the detected spurious and the limit line (limit line minus measurement value) (dB) Limit: Value of limit line to the frequency of the detected spurious (dBm)
[3]	Result	Display the result (Pass/Fail). Pass is displayed if all the segments are judged as Pass. If not, Fail is displayed.
[4]	Peaks/Worst	Displays the setting of Result Type.
[5]	---	A marker is displayed with the detected marker. The figure of the marker shows the spurious number. Spurious numbers are sorted by level.

Switch Time Domain to On while the measurement is being stopped, or change the limit line after performing the measurement when Time Domain is set to On. Then the remeasurement message, "Please sweep again." is displayed. Perform the measurement (Single) again, in order to display the result of Time Domain measurement.

Note:

When **Displayed Summary Table** is set to **Range**, the summary displays frequency range, RBW setting and VBW setting for each segment.





7.8 Two-tone Third Order Intermodulation Distortion

By inputting two different frequency CW signals (desired waves), two-tone third order intermodulation distortion is generated close to the desired waves according to non-linear characteristics of DUT. Then, TOI (Third Order Intercept) is calculated from the two-tone third order intermodulation distortion. Press **→** in the Measure function menu to display page 2 of the Measure function menu. Then press **F1** (TOI) to display the TOI function menu.



Figure 7.8-1 TOI function menu

Table 7.8-1 Description of the TOI function menu

Function key	Menu display	Function
Page 1	TOI	Appears when pressing  and  (TOI) in the Measure function menu.
F1	TOI (On/Off)	Turns off the other measurement functions if set to On.
F2	Frequency Auto Tune	Executes the TOI frequency auto tune.
F3	Tone Frequency Auto Manual	Selects whether to automatically detect the tone frequency.
F4	Lower Tone Frequency <Hz>	Sets the lower tone frequency. This cannot be set when the Tone Frequency is Auto.
F5	Upper Tone Frequency <Hz>	Sets the upper tone frequency. This cannot be set when the Tone Frequency is Auto.
F6	IM3 Frequency Search On/Off	Turns on and off the function of performing a peak search in the vicinity of the frequency at which IM3, calculated from two CW signals, occurs and then considering the peak detection frequency as IM3 frequency. Peak search is performed within the frequency range in which an error can occur due to Span, RBM, and Trace Point.
Page 2	TOI	Appears when pressing  and  (TOI) in the Measure function menu.
F1	Zero Span Measurement On/Off	Selects whether to execute the zero span measurement.
F2	Zero Span Bandwidth Auto/Manual	Toggles whether to set RBW for Zero Span Measurement automatically or manually. This cannot be set when the Zero Span Measurement is Off. This is switched to Manual when the zero span bandwidth is manually edited.
F3	Zero Span Bandwidth <Bandwidth>	Sets the RBW for the zero span measurement. This cannot be set when the Zero Span Measurement is Off.
F4	Zero Span Sweep Time Auto/Manual	Toggles whether to set Sweep Time for Zero Span Measurement automatically or manually. This cannot be set when the Zero Span Measurement is Off. This is switched to Manual when the zero span sweep time is manually edited.
F5	Zero Span Sweep Time <time>	Sets the sweep time for the zero span measurement. This cannot be set when the Zero Span Measurement is Off.

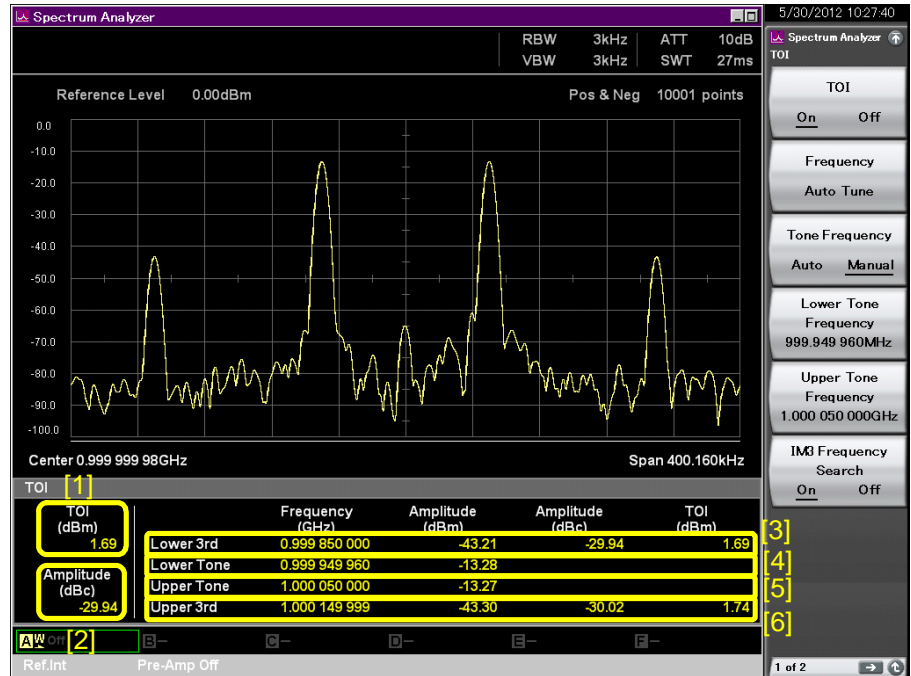

Figure 7.8-2 Display items for measurement results

Table 7.8-2 Description of display items for measurement results

No.	Item	Description
[1]	TOI (dBm)	Displays the calculated TOI. The Worst value (lower) between two calculated values (lower and upper) is displayed.
[2]	Amplitude (dBc)	Displays the level ratio of two-tone third-order intermodulation distortion to the desired wave. The Worst value (larger) between two calculated values (lower and upper) is displayed.
[3]	Lower 3rd	Two-tone third-order intermodulation distortion that occurs at the lower frequency of the desired wave. Frequency, signal level, level ratio to the desired wave, and calculated TOI are displayed.
[4]	Lower Tone	Desired wave that includes the lower frequency component. Frequency and signal level are displayed.
[5]	Upper Tone	Desired wave that includes the upper frequency component. Frequency and signal level are displayed.
[6]	Upper 3rd	Two-tone third-order intermodulation distortion that occurs at the upper frequency of the desired wave. Frequency, signal level, level ratio to the desired wave, and calculated TOI are displayed.

Chapter 8 Other Functions

This chapter describes the other functions of the Spectrum Analyzer function.

8.1	Selecting Other Function.....	8-2
8.2	Setting Title.....	8-3
8.3	Deleting Warmup Message	8-4
8.4	Setting Uncal Message	8-5
8.5	Adjusting Internal Reference Frequency Signal	8-5
8.6	Input Source for Reference Frequency Signal	8-7

8.1 Selecting Other Function

Pressing  (Accessory) on page 2 of the main function menu displays the Accessory function menu.

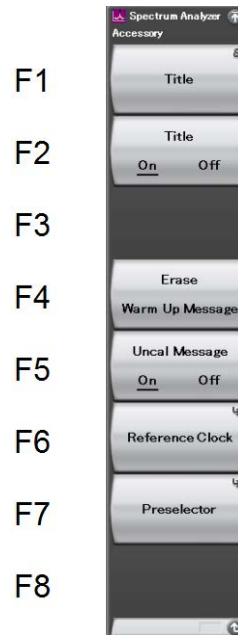







Figure 8.1-1 Accessory function menu

Table 8.1-1 Accessory function menu

Menu Display	Function
Title	Sets the title character string.  8.2 "Setting Title"
Title (On/Off)	Switches on/off title character string display.  8.2 "Setting Title"
Erase Warm Up Message	Deletes warmup message display.  8.3 "Deleting Warmup Message"
Uncal Message (On/Off)	Switches on/off Uncal message display.  8.4 "Setting Uncal Message"
Reference Clock	Adjusts the internal reference frequency signal.  8.5 "Adjusting Internal Reference Frequency Signal"
Preselector	Performs preselector settings.  6.1 "Preselector Tuning Function"

8.2 Setting Title

A title of up to 32 characters can be displayed on the screen. (Character strings of up to 17 characters can be displayed on a function menu.)

<Procedure>

1. Press **F8** (Accessory) on page 2 of the main function menu.
2. Press **F1** (Title) to display the character string input screen. Select the characters with the rotary knob and input them by pressing **Enter**. Once input is completed, press **F7** (Set).
3. It is also possible to hide the title display by pressing **F2** (Title) and selecting “Off.”

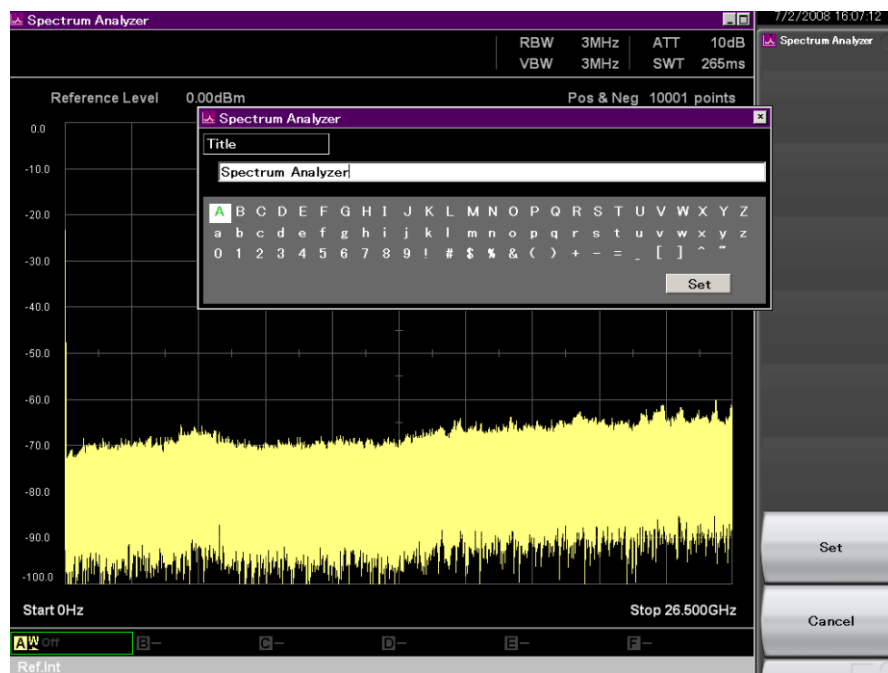





Figure 8.2-1 Setting title

8.3 Deleting Warmup Message

If the warmup message () indicating that the level and frequency are not stable is displayed upon power on, the message can be deleted.

<Procedure>

1. Press  (Accessory) on page 2 of the main function menu.
2. Press  (Erase Warm Up Message) to delete the warmup message.

8.4 Setting Uncal Message

The Spectrum Analyzer function can also execute measurements when values for which the results cannot be guaranteed are set. In this case, the Uncal message is displayed on the screen. Display of the Uncal message can be switched on/off.

<Procedure>

1. Press **F8** (Accessory) on page 2 of the main function menu.
2. Press **F5** (Uncal Message) and set either On or Off.

8.5 Adjusting Internal Reference Frequency Signal

Pressing **F8** (Reference Clock) from the Accessory function menu displays the Reference Clock function menu.

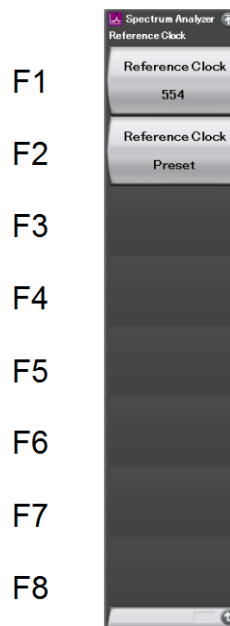





Figure 8.5-1 Reference Clock function menu

Table 8.5-1 Reference Clock function menu

Function keys	Menu Display	Function
F1	Reference Clock	Adjusts the frequency of the internal reference frequency signal.
F2	Reference Clock Preset	Resets the Reference Clock to the factory-default value.

Example: Adjusting the reference clock

<Procedure>

1. Press  (Accessory) on the page 1 of main function menu.
2. Press  (Reference Clock) and then press  (Reference Clock) to adjust the frequency of the internal reference frequency signal.

8.6 Input Source for Reference Frequency Signal

The reference frequency signal used is displayed on the screen.

Ref. Int : The internal reference frequency signal is used.

Ref. Int Unlock : The internal reference frequency signal is unlocked.
The internal hardware may be faulty.

Ref. Ext : The external reference frequency signal is used.

Ref. Ext Unlock: Not in sync with the external reference frequency signal. Check the reference signal input to the Ref Input connector.

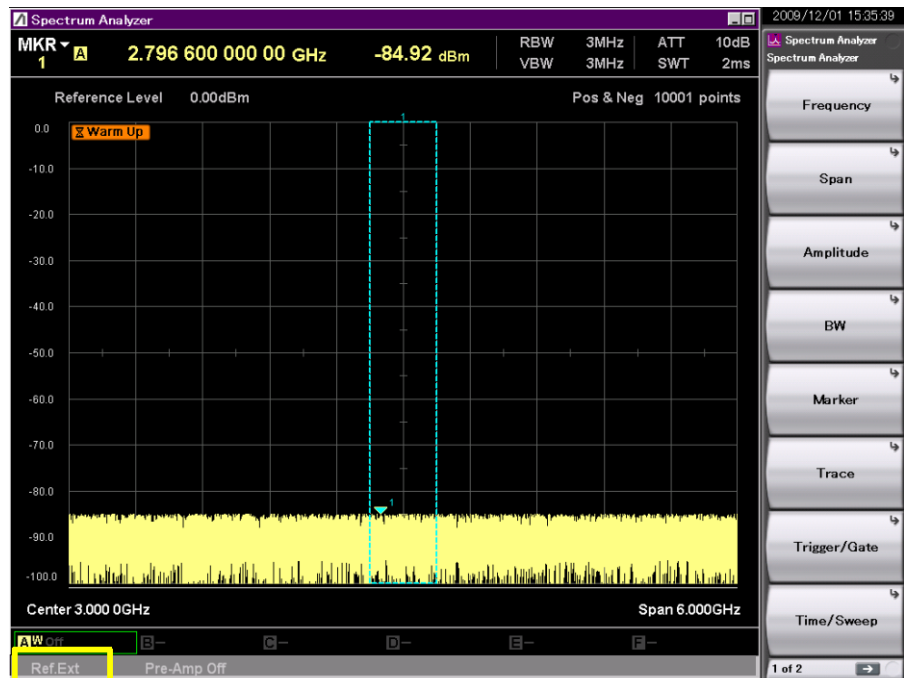

Figure 8.6-1 Input Source for Reference Frequency Signal

Appendix A Error Messages

Table A-1 Error Messages

Message	Explanation
Out of range.	The settable range is exceeded.
Not available in Frequency Domain.	This operation is invalid during frequency domain display.
Not available in Time Domain.	This operation is invalid during time domain display.
Not available if not Pre-selector lower frequency expansion option.	This operation is invalid when the preselector lower limit frequency extension option is not installed.
Not available in frequency band without the Preselector pass frequency band	This operation is invalid when a band other than the preselector band is used.
Not available if Frequency Span is set over multiple band.	This operation is invalid when the frequency span overlaps several frequency bands.
Not available in Frequency Span > 500MHz.	This operation is invalid when the frequency span exceeds 500 MHz.
Not available in Time Span < 5ms.	This operation is invalid when the time span is less than 5 ms.
Cannot Set under 4 dB with Step Key and Encoder. Please Input with Numeric Key.	An attenuator setting of less than 4 dB requires the input of numeric keys.
Not available in Lin Scale.	This operation is invalid when Scale Mode is set to "Linear."
Signal not found	No signal is input.
Search error	Search error
Marker value is invalid.	The marker value is invalid.
Not available in Marker Off.	This operation is invalid when Marker is in the Off state.
Not available in Power Marker Off.	This operation is invalid when Power Marker is in the Off state.
Not available in Power Marker On.	This operation is invalid when Power Marker is in the On state.
Not available if not Delta Marker.	This operation is invalid when Delta Marker is not in the On state.
Not available in Trace Blank.	This operation is invalid when Active Trace is in the Blank state.
Not available in RMS detection.	This operation is invalid when Detection is in the RMS state.
Not available in Trigger On.	This operation is invalid when Trigger is in the On state.
Not available in Gate On.	This operation is invalid when Gate is in the On state.
Not available in Gate Off.	This operation is invalid when Gate is in the Off state.
Not available if not Trigger/Gate On	This operation is invalid when Trigger/Gate is not in the On state.
Not available if not Pre-Amplifier option.	This operation is invalid when Option 008 6 GHz Pre-amp is not installed.

Table A-1 Error Messages (Cont'd)

Message	Explanation
Not available in SG Marker Trigger.	This operation is invalid when SG Marker Trigger is used.
Not available if not Vector Signal Generator option.	This operation is invalid when Option 020 Vector Signal Generator is not installed.
Standard Parameter isn't found.	Standard Parameter is not found.
Not available when Standard is set to OFF.	This operation is invalid when Standard is off.
Not available if not Nyquist or Root Nyquist filter.	This operation is invalid when Nyquist filter or root Nyquist filter is not selected.
Cal suspended	Calibration is suspended.
Invalid Button	Invalid key operation.
Not available because model name does not match.	Invalid operation because model name does not match.
Not available because option configuration does not match	Invalid operation because option configuration does not match.
Not available if save file name not input.	Invalid operation when save file name has not been input.
Not available over the maximum number of characters.	Invalid operation because maximum number of characters has been exceeded.
Hardware setting failure.	Hardware setting failed.
Media not found.	Media was not found.
Format error.	Media is not formatted.
File not found.	File was not found.
File Open error.	File Open failed.
File Close error.	File Close failed.
Read/Write error.	Read/Write failed.
Disk is full.	Free disc capacity is insufficient.
Not available in already saved maximum number of files in the selected device.	Invalid operation when maximum number of files has been saved to the specified device.
Undefined command header	Undefined command.
Invalid numeric data	Invalid numeric parameter.

Table A-1 Error Messages (Cont'd)

Message	Explanation
Not available in ACP and Burst Average Power Off.	The operation is invalid while ACP and Burst Average Power are set to Off.
Not available in ACP Off.	The operation is invalid while ACP is set to Off.
Not available in Burst Average Power Off.	The operation is invalid while Burst Average Power is set to Off.
Not available in Standard Off.	The operation is invalid while Standard is set to Off.
Not available when unsupported Standard Parameter is selected.	Standard Parameter does not support the noise canceling function.
Not available when Load Standard Parameter isn't executed.	It is necessary to execute Load Standard Parameter.
Not available while executing Noise Measurement.	It cannot be changed or modified during noise measurement.
Not available when ACP Reference is set to Span Total.	ACP Reference is set to Span Total.
Not available if not Reference Mode Fix.	The operation is invalid while Reference Mode is set to Fix.
Not available if not Reference Mode Channel.	The operation is invalid while Reference Mode is set to Channel.
Not available in Spectrum Emission Mask On.	The operation is invalid while Spectrum Emission Mask is set to On.
Not available in Spectrum Emission Mask Off.	The operation is invalid while Spectrum Emission Mask is set to Off.
Not available if not RMS detection.	The operation is invalid while Detection is set to RMS.
Not available in Measure On.	The operation is invalid while Measure is set to On.
The active marker cannot be set.	Active Marker cannot be set.
The target marker cannot be set.	Target Marker cannot be set.
Not available when Marker Result isn't set to Peak.	The operation is invalid while Marker Result is set to other than Peak.
Not Available in Couple Ref&ATT On.	The operation is invalid while Couple Ref&ATT is set to On.
Not available in Segment Off.	The operation is invalid while Segment is set to Off.
Cannot set all segments to Off at the same time.	You cannot set all the segments to Off at the same time.
Not available in Spurious Emission On.	The operation is invalid while Spurious Emission is set to On.
No Parameter.	There is no parameter.
Not available in Time Domain Measurement On.	The operation is invalid while Time Domain Measurement is set to On.
Not available during measurement, and Displayed Segment Mode is set to Auto.	This command is invalid during measurement and when Displayed Segment Mode is set to Auto.
Available in remote control state with Spurious Emission paused.	This command can use only when the MS2690A/MS2691A/MS2692A is set to remote control state and Spurious Emission is paused.

Table A-1 Error Messages (Cont'd)

Message	Explanation
Not available when Gate View is set to Off.	The operation is invalid when Gate View is set to Off.
Not available when all traces are set to Blank.	The operation is invalid when all traces are set to Blank.
Not available when Spurious Emission is set to Off.	The operation is invalid when Spurious Emission is set to Off.
Not available when Spectrum Emission Mask is set to On and Gate View is set to Off.	The operation is invalid when Spectrum Emission Mask is set to On and when Gate View is set to Off.
Not available when Spurious Emission is set to On and Gate View is set to Off.	The operation is invalid when Spurious Emission is set to On and when Gate View is set to Off.
Not available in Freq. Count Off.	—
Invalid character	—

Appendix B Default Value List

Frequency			
Center	3 GHz	(MS2690A)	
	6.75 GHz	(MS2691A)	
	13.25 GHz	(MS2692A)	
Start	0 Hz		
Stop	6 GHz	(MS2690A)	
	13.5 GHz	(MS2691A)	
	26.5 GHz	(MS2692A)	
Offset	Off, 0 Hz		
Step Size	1 GHz		
Span			
Span	6 GHz	(MS2690A)	
	13.5 GHz	(MS2691A)	
	26.5 GHz	(MS2692A)	
Couple Time/Frequency Domain			
	On		
Frequency Band Mode	Normal		
Amplitude			
Reference Level	0 dBm		
Attenuator	Auto, 10 dB		
Log Scale Unit	dBm		
Scale	Log		
Log Scale Division	10 dB/Div		
Log Scale Line	10		
Offset	Off, 0 dB		
Pre-amp	Off		
BW			
RBW	Auto, 3 MHz		
VBW	Auto, 3 MHz		
VBW Mode	Power		
Marker			
Active Marker	Marker1		
Marker Mode	Normal		
Zone Width	600 MHz	(MS2690A)	
	1.35 GHz	(MS2691A)	
	2.65 GHz	(MS2692A)	
Marker Trace	A		
Marker Result	Peak		
Marker Type	Zone		
Couple Zone	On		
Spot Line	On		

Appendix B Default Value List

Marker List	Off
Frequency Count	Off
Gate Time	100 ms
Relative to	Marker2 (Active Marker is 1)
	Marker3 (Active Marker is 2)
	Marker4 (Active Marker is 3)
	Marker5 (Active Marker is 4)
	Marker6 (Active Marker is 5)
	Marker7 (Active Marker is 6)
	Marker8 (Active Marker is 7)
	Marker9 (Active Marker is 8)
	Marker10 (Active Marker is 9)
	Marker1 (Active Marker is 10)

Trace

Trace-A Trace Type	Write
Trace-B Trace Type	Blank
Trace-C Trace Type	Blank
Trace-D Trace Type	Blank
Trace-E Trace Type	Blank
Trace-F Trace Type	Blank
Trace-A Storage Mode	Off
Trace-B Storage Mode	Off
Trace-C Storage Mode	Off
Trace-D Storage Mode	Off
Trace-E Storage Mode	Off
Trace-F Storage Mode	Off
Storage Count	10

Limits

Limit 1 to 6

Type	On
Limit Display	Off
Limit Test	Off
Margin	Off
Margin Value	0 dB

Edit

Point	1
Frequency	Center Frequency
Connected to Previous Pt	On
Previous Pt Level Offset	0.0 dB

Envelope

Points	41
Offset	3.0 dB

Shape	Square
Limit Line Type (Frequency)	Rel
Limit Line Type (Amplitude)	Abs
Mirror Limit	Off
Detection	Pos & Neg
Trigger/Gate	
Trigger Switch	Off
Trigger Source	Video
Trigger Slope	Rise
Trigger Level (Video)	-40 dBm
Trigger Level (Wide IF Video)	-20 dBm
Trigger Delay	0 s
Gate Sweep	Off
Gate View	Off
Gate Delay	0 s
Gate Length	1.0 ms
Gate Source	External
Gate Slope	Rise
Gate Level (Wide IF Video)	-20 dBm

Appendix B Default Value List

Gate View Setting		
Sweep Time	100 ms	
RBW	Auto, 3 MHz	
VBW	Auto, 3 MHz	
Detection	Pos & Neg	
Trace Point	10001	
Gate View Frequency	Auto, 3 GHz (MS2690A)	
	Auto, 6.75 GHz (MS2691A)	
	Auto, 13.25 GHz (MS2692A)	
Reference Level	0 dBm	
Attenuator	Auto, 10 dB	
Pre-Amp	Off	
Time/Sweep		
Sweep Time (Frequency Domain)		
	Auto, 10 ms	(MS2690A)
	Auto, 135 ms	(MS2691A)
	Auto, 265 ms	(MS2692A)
Sweep Time (Time Domain)	100 ms	
Auto Sweep Time Select	Normal	
Trace Point	10001	
Peak Search		
Resolution	2 dB	
Threshold	Off, Above	
Threshold Level	-50 dBm	
Search Peaks Number	10	
Save on Event		
Save on Event	Off	
Event Type	Limit Fail	
Save then Stop	Off	
File Name	LIM	
Accessory		
Title	On, "Spectrum Analyzer"	
Uncal Message	On	
Reference Clock	Value adjusted at factory shipping	
Preselector	Value adjusted at factory shipping	
Measure		
ACP		
On/Off	Off	

Reference	Both Sides of Carriers
Offset Ch BW	3.84 MHz
Carrier BW	3.84 MHz
In Band Center	Center Frequency
Carrier Spacing	5 MHz
Offset-1	On, 5 MHz
Offset-2	On, 10 MHz
Offset-3	Off, 15 MHz
In Band Filter Type	Root Nyquist
Offset Ch Filter Type	Root Nyquist
In Band Roll-off Factor	0.22
Offset Ch Roll-off Factor	0.22
Noise Cancel	Off
Result Type	Offset
Carrier Number	1
Burst Average Power	
On/Off	Off
Start Time	0 s
Stop Time	100 ms
Noise Cancel	Off

Appendix B Default Value List

Channel Power

On/Off	Off
Channel Center	Center Frequency
Channel Width	3.84 MHz
Filter Type	Root Nyquist
Roll-off Factor	0.22

OBW

On/Off	Off
Method	N%
N% of Ratio	99%
XdB Value	25 dB

Spectrum Emission Mask

On/Off	Off
Limit Side	Both
Result Type	Peak
Reference Mode	Channel
Reference Power	0 dBm
Channel BW	3.84 MHz
Attenuator	Auto, 10 dB
RBW Auto/Manual	Manual, 30 kHz
VBW Auto/Manual	Auto, 30 kHz
VBW Mode	Power
Sweep Time	Auto, 19 ms
Auto Sweep Time Select	Normal
Detection	RMS
Trace Point	1001
Filter Type	Root Nyquist
Roll-off Factor	0.22
Couple Ref&ATT	On
Edit Offset Number	1
Offset-1	

Offset	On
Start Freq	2.515 MHz
Stop Freq	2.715 MHz
Reference Level	Auto, 0 dBm
Attenuator	Auto, 10 dB
RBW	Manual, 30 kHz
VBW	Auto, 30 kHz
VBW Mode	Power
Sweep Time	Auto, 2 ms
Auto Sweep Time Select	Normal
Detection	RMS

	Trace Point	1001
	Integrate BW	Auto, 30 kHz
	ABS1 Start Level	-12.5 dBm
	ABS1 Stop Level	-12.5 dBm
	REL Start Level	0 dB
	REL Stop Level	0 dB
	ABS2 Start Level	-15 dBm
	ABS2 Stop Level	-15 dBm
	Fail Logic	ABS1
Offset-2	Offset	On
	Start Freq	2.715 MHz
	Stop Freq	3.515 MHz
	Reference Level	Auto, 0 dBm
	Attenuator	Auto, 10 dB
	RBW	Manual, 30 kHz
	VBW	Auto, 30 kHz
	VBW Mode	Power
	Sweep Time	Auto, 4 ms
	Auto Sweep Time Select	Normal
	Detection	RMS
	Trace Point	1001
	Integrate BW	Auto, 30 kHz
	ABS1 Start Level	-12.5 dBm
	ABS1 Stop Level	-24.5 dBm
	REL Start Level	0 dB
	REL Stop Level	0 dB
	ABS2 Start Level	-15 dBm
	ABS2 Stop Level	-15 dBm
	Fail Logic	ABS1
Offset-3	Offset	On
	Start Freq	3.515 MHz
	Stop Freq	4 MHz
	Reference Level	Auto, 0 dBm
	Attenuator	Auto, 10 dB
	RBW	Manual, 30 kHz
	VBW	Auto, 30 kHz
	VBW Mode	Power
	Sweep Time	Auto, 2 ms
	Auto Sweep Time Select	Normal
	Detection	RMS
	Trace Point	1001
	Integrate BW	Auto, 30 kHz

Appendix B Default Value List

	ABS1 Start Level	-24.5 dBm
	ABS1 Stop Level	-24.5 dBm
	REL Start Level	0 dB
	REL Stop Level	0 dB
	ABS2 Start Level	-15 dBm
	ABS2 Stop Level	-15 dBm
	Fail Logic	ABS1
Offset-4		
	Offset	On
	Start Freq	4 MHz
	Stop Freq	8 MHz
	Reference Level	Auto, 0 dBm
	Attenuator	Auto, 10 dB
	RBW	Manual, 1 MHz
	VBW	Auto, 1 MHz
	VBW Mode	Power
	Sweep Time	Auto, 2 ms
	Auto Sweep Time Select	Normal
	Detection	RMS
	Trace Point	1001
	Integrate BW	Auto, 1 MHz
	ABS1 Start Level	-11.5 dBm
	ABS1 Stop Level	-11.5 dBm
	REL Start Level	0 dB
	REL Stop Level	0 dB
	ABS2 Start Level	-13 dBm
	ABS2 Stop Level	-13 dBm
	Fail Logic	ABS1
Offset-5		
	Offset	On
	Start Freq	8 MHz
	Stop Freq	12.5 MHz
	Reference Level	Auto, 0 dBm
	Attenuator	Auto, 10 dB
	RBW	Manual, 1 MHz
	VBW	Auto, 1 MHz
	VBW Mode	Power
	Sweep Time	Auto, 2 ms
	Auto Sweep Time Select	Normal
	Detection	RMS
	Trace Point	1001
	Integrate BW	Auto, 1 MHz
	ABS1 Start Level	-11.5 dBm
	ABS1 Stop Level	-11.5 dBm

	REL Start Level	0 dB
	REL Stop Level	0 dB
	ABS2 Start Level	-13 dBm
	ABS2 Stop Level	-13 dBm
	Fail Logic	ABS1
Offset-6		
	Offset	Off
	Start Freq	12.5 MHz
	Stop Freq	15 MHz
	Reference Level	Auto, 0 dBm
	Attenuator	Auto, 10 dB
	RBW	Manual, 1 MHz
	VBW	Auto, 1 MHz
	VBW Mode	Power
	Sweep Time	Auto, 2 ms
	Auto Sweep Time Select	Normal
	Detection	RMS
	Trace Point	1001
	Integrate BW	Auto, 1 MHz
	ABS1 Start Level	-11.5 dBm
	ABS1 Stop Level	-11.5 dBm
	REL Start Level	0 dB
	REL Stop Level	0 dB
	ABS2 Start Level	-13 dBm
	ABS2 Stop Level	-13 dBm
	Fail Logic	Off

Appendix B Default Value List

Spurious Emission

On/Off	Off
Displayed Segment	1
Page of Summary	Auto
Result Type	Worst
Time Domain Measurement	Off
Fail Stop	Off
Displayed Segment Mode	Auto
Displayed Summary Table	Result

Segment-1

Segment Setup

Segment	On
Start Freq	9 kHz
Stop Freq	150 kHz
Reference Level	0 dBm
Attenuator	Auto, 10 dB
Detection	Positive
RBW	Manual, 1 kHz
VBW	Auto, 1 kHz
Sweep Time	Auto
Trace Point	1001
Couple Storage Count	On
Storage Count	10
Pause before Sweep	Off
Correction	Common
Preamp	Off

Limit Setup

Start Level	-13 dBm
Stop Level	Auto, -13 dBm
Search Resolution	6 dB
Threshold Level	-90 dBm

Time Domain Setup

Couple Segment RBW	On, 1 kHz
Couple Segment VBW	On
Sweep Time	100 ms
Detection	RMS

Segment-2

Segment Setup

Segment	On
Start Freq	150 kHz
Stop Freq	30 MHz
Reference Level	0 dBm
Attenuator	Auto, 10 dB
Detection	Positive

	RBW	Manual, 10 kHz
	VBW	Auto, 10 kHz
	Sweep Time	Auto
	Trace Point	5001
	Couple Storage Count	On
	Storage Count	10
	Pause before Sweep	Off
	Correction	Common
	Preamp	Off
	Limit Setup	
	Start Level	-13 dBm
	Stop Level	Auto, -13 dBm
	Search Resolution	6 dB
	Threshold Level	-90 dBm
	Time Domain Setup	
	Couple Segment RBW	On, 10 kHz
	Couple Segment VBW	On, 10 kHz
	Sweep Time	100 ms
	Detection	RMS
Segment-3	Segment Setup	
	Segment	On
	Start Freq	30 MHz
	Stop Freq	1 GHz
	Reference Level	0 dBm
	Attenuator	Auto, 10 dB
	Detection	Positive
	RBW	Manual, 100 kHz
	VBW	Auto, 100 kHz
	Sweep Time	Auto
	Trace Point	10001
	Couple Storage Count	On
	Storage Count	10
	Pause before Sweep	Off
	Correction	Common
	Preamp	Off
	Limit Setup	
	Start Level	-13 dBm
	Stop Level	Auto, -13 dBm
	Search Resolution	6 dB
	Threshold Level	-90 dBm
	Time Domain Setup	
	Couple Segment RBW	On, 100 kHz
	Couple Segment VBW	On, 100 kHz

Appendix B Default Value List

	Sweep Time	100 ms
	Detection	RMS
Segment-4		
	Segment Setup	
	Segment	On
	Start Freq	1 GHz
	Stop Freq	2 GHz
	Reference Level	0 dBm
	Attenuator	Auto, 10 dB
	Detection	Positive
	RBW	Manual, 1 MHz
	VBW	Auto, 1 MHz
	Sweep Time	Auto
	Trace Point	10001
	Couple Storage Count	On
	Storage Count	10
	Pause before Sweep	Off
	Correction	Common
	Preamplifier	Off
	Limit Setup	
	Start Level	-13 dBm
	Stop Level	Auto, -13 dBm
	Search Resolution	6 dB
	Threshold Level	-90 dBm
	Time Domain Setup	
	Couple Segment RBW	On, 1 MHz
	Couple Segment VBW	On, 1 MHz
	Sweep Time	100 ms
	Detection	RMS
Segment-5		
	Segment Setup	
	Segment	On
	Start Freq	2 GHz
	Stop Freq	3 GHz
	Reference Level	0 dBm
	Attenuator	Auto, 10 dB
	Detection	Positive
	RBW	Manual 1 MHz
	VBW	Auto
	Sweep Time	Auto
	Trace Point	10001
	Couple Storage Count	On
	Storage Count	10
	Pause before Sweep	Off

	Correction	Common
	Preamp	Off
	Limit Setup	
	Start Level	-13 dBm
	Stop Level	Auto, -13 dBm
	Search Resolution	6 dB
	Threshold Level	-90 dBm
	Time Domain Setup	
	Couple Segment RBW	On
	Couple Segment VBW	On
	Sweep Time	100 ms
	Detection	RMS
Segment-6	Segment Setup	
	Segment	On
	Start Freq	3 GHz
	Stop Freq	4 GHz
	Reference Level	0 dBm
	Attenuator	Auto, 10 dB
	Detection	Positive
	RBW	Manual 1 MHz
	VBW	Auto
	Sweep Time	Auto
	Trace Point	10001
	Couple Storage Count	On
	Storage Count	10
	Pause before Sweep	Off
	Correction	Common
	Preamp	Off
	Limit Setup	
	Start Level	-13 dBm
	Stop Level	Auto, -13 dBm
	Search Resolution	6 dB
	Threshold Level	-90 dBm
	Time Domain Setup	
	Couple Segment RBW	On
	Couple Segment VBW	On
	Sweep Time	100 ms
	Detection	RMS
Segment-7	Segment Setup	
	Segment	On
	Start Freq	4 GHz
	Stop Freq	5 GHz

Appendix B Default Value List

	Reference Level	0 dBm
	Attenuator	Auto, 10 dB
	Detection	Positive
	RBW	Manual 1 MHz
	VBW	Auto
	Sweep Time	Auto
	Trace Point	10001
	Couple Storage Count	On
	Storage Count	10
	Pause before Sweep	Off
	Correction	Common
	Preamp	Off
	Limit Setup	
	Start Level	-13 dBm
	Stop Level	Auto, -13 dBm
	Search Resolution	6 dB
	Threshold Level	-90 dBm
	Time Domain Setup	
	Couple Segment RBW	On
	Couple Segment VBW	On
	Sweep Time	100 ms
	Detection	RMS
Segment-8	Segment Setup	
	Segment	On
	Start Freq	5 GHz
	Stop Freq	6 GHz
	Reference Level	0 dBm
	Attenuator	Auto, 10 dB
	Detection	Positive
	RBW	Manual 1 MHz
	VBW	Auto
	Sweep Time	Auto
	Trace Point	10001
	Couple Storage Count	On
	Storage Count	10
	Pause before Sweep	Off
	Correction	Common
	Preamp	Off
	Limit Setup	
	Start Level	-13 dBm
	Stop Level	Auto, -13 dBm
	Search Resolution	6 dB
	Threshold Level	-90 dBm

	Time Domain Setup	
	Couple Segment RBW	On
	Couple Segment VBW	On
	Sweep Time	100 ms
	Detection	RMS
Segment-9	Segment Setup	
	Segment	On (For MS2690A, it is set to Off)
	Start Freq	6 GHz (For MS2690A, it is set to 1 GHz)
	Stop Freq	7 GHz (For MS2690A, it is set to 6 GHz)
	Reference Level	0 dBm
	Attenuator	Auto, 10 dB
	Detection	Positive
	RBW	Manual, 1 MHz (For MS2690A, it is set to Auto)
	VBW	Auto
	Sweep Time	Auto
	Trace Point	10001
	Couple Storage Count	On
	Storage Count	10
	Pause before Sweep	Off
	Correction	Common
	Preamp	Off
	Limit Setup	
	Start Level	-13 dBm
	Stop Level	Auto, -13 dBm
	Search Resolution	6 dB
	Threshold Level	-90 dBm
	Time Domain Setup	
	Couple Segment RBW	On
	Couple Segment VBW	On
	Sweep Time	100 ms
	Detection	RMS
Segment-10	Segment Setup	
	Segment	On (For MS2690A, it is set to Off)
	Start Freq	7 GHz (For MS2690A, it is set to 1 GHz)
	Stop Freq	8 GHz (For MS2690A, it is set to 6 GHz)

Appendix B Default Value List

Reference Level 0 dBm
Attenuator Auto, 10 dB
Detection Positive
RBW Manual, 1 MHz
(For MS2690A, it is set to Auto)
VBW Auto
Sweep Time Auto
Trace Point 10001
Couple Storage Count On
Storage Count 10
Pause before Sweep Off
Correction Common
Preamp Off

Limit Setup

Start Level -13 dBm
Stop Level Auto, -13 dBm
Search Resolution 6 dB
Threshold Level -90 dBm

Time Domain Setup

Couple Segment RBW On
Couple Segment VBW On
Sweep Time 100 ms
Detection RMS

Segment-11

Segment Setup

Segment On
(For MS2690A, it is set to Off)
Start Freq 8 GHz
(For MS2690A, it is set to 1 GHz)
Stop Freq 9 GHz
(For MS2690A, it is set to 6 GHz)
Reference Level 0 dBm
Attenuator Auto, 10 dB
Detection Positive
RBW Manual, 1 MHz
(For MS2690A, it is set to Auto)
VBW Auto
Sweep Time Auto
Trace Point 10001
Couple Storage Count On
Storage Count 10
Pause before Sweep Off
Correction Common
Preamp Off

Limit Setup

Start Level -13 dBm
 Stop Level Auto, -13 dBm
 Search Resolution 6 dB
 Threshold Level -90 dBm

Time Domain Setup

Couple Segment RBW On
 Couple Segment VBW On
 Sweep Time 100 ms
 Detection RMS

Segment-12

Segment Setup

Segment On
 (For MS2690A, it is set to Off)
 Start Freq 9 GHz
 (For MS2690A, it is set to 1 GHz)
 Stop Freq 10 GHz
 (For MS2690A, it is set to 6 GHz)
 Reference Level 0 dBm
 Attenuator Auto, 10 dB
 Detection Positive
 RBW Manual, 1 MHz
 (For MS2690A, it is set to Auto)
 VBW Auto
 Sweep Time Auto
 Trace Point 10001
 Couple Storage Count On
 Storage Count 10
 Pause before Sweep Off
 Correction Common
 Preamp Off

Limit Setup

Start Level -13 dBm
 Stop Level Auto, -13 dBm
 Search Resolution 6 dB
 Threshold Level -90 dBm

Time Domain Setup

Couple Segment RBW On
 Couple Segment VBW On
 Sweep Time 100 ms
 Detection RMS

Segment-13

Segment Setup

Appendix B Default Value List

Segment On
(For MS2690A, it is set to Off)
Start Freq 10 GHz
(For MS2690A, it is set to 1 GHz)
Stop Freq 11 GHz
(For MS2690A, it is set to 6 GHz)
Reference Level 0 dBm
Attenuator Auto, 10 dB
Detection Positive
RBW Manual, 1 MHz
(For MS2690A, it is set to Auto)
VBW Auto
Sweep Time Auto
Trace Point 10001
Couple Storage Count On
Storage Count 10
Pause before Sweep Off
Correction Common
Preamp Off

Limit Setup

Start Level -13 dBm
Stop Level Auto, -13 dBm
Search Resolution 6 dB
Threshold Level -90 dBm

Time Domain Setup

Couple Segment RBW On
Couple Segment VBW On
Sweep Time 100 ms
Detection RMS

Segment-14

Segment Setup

Segment On
(For MS2690A, it is set to Off)
Start Freq 11 GHz
(For MS2690A, it is set to 1 GHz)
Stop Freq 12 GHz
(For MS2690A, it is set to 6 GHz)
Reference Level 0 dBm
Attenuator Auto, 10 dB
Detection Positive
RBW Manual, 1 MHz
(For MS2690A, it is set to Auto)
VBW Auto
Sweep Time Auto

	Trace Point	10001	
	Couple Storage Count		On
	Storage Count	10	
	Pause before Sweep		Off
	Correction	Common	
	Preamp	Off	
	Limit Setup		
	Start Level	-13 dBm	
	Stop Level	Auto, -13 dBm	
	Search Resolution		6 dB
	Threshold Level	-90 dBm	
	Time Domain Setup		
	Couple Segment RBW		On
	Couple Segment VBW		On
	Sweep Time	100 ms	
	Detection	RMS	
Segment-15	Segment Setup		
	Segment	On	
		(For MS2690A, it is set to Off)	
	Start Freq	12 GHz	
		(For MS2690A, it is set to 1 GHz)	
	Stop Freq	12.75 GHz	
		(For MS2690A, it is set to 6 GHz)	
	Reference Level	0 dBm	
	Attenuator	Auto, 10 dB	
	Detection	Positive	
	RBW	Manual, 1 MHz	
		(For MS2690A, it is set to Auto)	
	VBW	Auto	
	Sweep Time	Auto	
	Trace Point	10001	
	Couple Storage Count		On
	Storage Count	10	
	Pause before Sweep		Off
	Correction	Common	
	Preamp	Off	
	Limit Setup		
	Start Level	-13 dBm	
	Stop Level	Auto, -13 dBm	
	Search Resolution		6 dB
	Threshold Level	-90 dBm	
	Time Domain Setup		
	Couple Segment RBW		On

Appendix B Default Value List

	Couple Segment VBW	On
	Sweep Time	100 ms
	Detection	RMS
Segment-16 to 20		
	Segment Setup	
	Segment	Off
	Start Freq	1 GHz
	Stop Freq	12.75 GHz
		(For MS2690A, it is set to 6 GHz)
	Reference Level	0 dBm
	Attenuator	Auto, 10 dB
	Detection	Positive
	RBW	Auto
	VBW	Auto
	Sweep Time	Auto
	Trace Point	10001
	Couple Storage Count	On
	Storage Count	10
	Pause before Sweep	Off
	Correction	Common
	Preamplifier	Off
	Limit Setup	
	Start Level	-13 dBm
	Stop Level	Auto, -13 dBm
	Search Resolution	6 dB
	Threshold Level	-90 dBm
	Time Domain Setup	
	Couple Segment RBW	On
	Couple Segment VBW	On
	Sweep Time	100 ms
	Detection	RMS

Segment-16 to 20

Segment Setup

Segment	Off
Start Freq	1 GHz
Stop Freq	12.75 GHz
(For MS2690A, it is set to 6 GHz)	
Reference Level	0 dBm
Attenuator	Auto, 10 dB
Detection	Positive
RBW	Auto
VBW	Auto
Sweep Time	Auto
Trace Point	10001
Couple Storage Count	On
Storage Count	10
Pause before Sweep	Off
Correction	Common
Preamplifier	Off

Limit Setup

Start Level	-13 dBm
Stop Level	Auto, -13 dBm
Search Resolution	6 dB
Threshold Level	-90 dBm

Time Domain Setup

Couple Segment RBW	On
Couple Segment VBW	On
Sweep Time	100 ms

Detection RMS

Appendix C Standard Parameter List

The parameters set by the standard functions are listed below.

C-1	ACP	C-3
	W-CDMA	C-3
	Mobile WiMAX	C-8
	LTE	C-10
	DSRC	C-54
	TD-SCDMA	C-56
	CDMA2000	C-68
	EV-DO	C-69
	TELEC-T403	C-70
	TELEC-T405	C-74
	BPSK	C-76
	GFSK	C-77
	APCO	C-86
	NXDN	C-90
C-2	Burst Average Power	C-92
	W-CDMA/Mobile WiMAX/LTE/DSRC	C-92
	TD-SCDMA/LTE TDD/CDMA2000/EV-DO	C-93
C-3	Channel Power	C-94
	W-CDMA	C-94
	Mobile WiMAX	C-95
	LTE	C-96
	LTE TDD	C-100
	DSRC	C-104
	TD-SCDMA/XG-PHS/CDMA2000/EV-DO	C-105
	ISDB-Tmm/ISDB-T	C-107
	ISDB-T _{SB}	C-108
C-4	OBW	C-109
	W-CDMA/Mobile WiMAX	C-109
	LTE	C-110
	LTE TDD	C-112
	DSRC	C-114
	TD-SCDMA/XG-PHS/CDMA2000/EV-DO	C-115
	ISDB-Tmm/ISDB-T/ISDB-T _{SB}	C-117
	TELEC-T401/TELEC-T403	C-118
	TELEC-T405	C-120
	ETSI EN 301 893	C-121
C-5	SEM	C-123
	W-CDMA	C-123
	Mobile WiMAX	C-150
	LTE/LTE TDD Downlink	C-156

Appendix C Standard Parameter List

	LTE/LTE TDD Uplink.....	C-204
	TD-SCDMA	C-256
	XG-PHS.....	C-286
	CDMA2000.....	C-289
	EV-DO	C-325
	ISDB-Tmm.....	C-338
	ISDB-T.....	C-345
	ISDB-T _{SB}	C-347
	SEM 802.11a.....	C-350
	SEM 802.11b.....	C-352
	SEM 802.11g.....	C-354
	SEM 802.11j.....	C-360
	SEM 802.11p.....	C-362
	SEM 802.11n.....	C-364
	SEM 802.11ac.....	C-372
	ETSI EN 301 893	C-380
	O-QPSK.....	C-392
	BPSK.....	C-393
	GFSK.....	C-394
	APCO P25.....	C-400
	Microlink ETSI CS: 7MHz.....	C-404
	Microlink ETSI CS: 14MHz.....	C-422
	Microlink ETSI CS: 28MHz.....	C-440
	Microlink ETSI CS: 56MHz.....	C-476
	TELEC-T403	C-500
	NXDN	C-537
C-6	Spurious Emission	C-541
	TELEC-T401	C-541
	TELEC-T402	C-544
	TELEC-T403	C-546
	TELEC-T405	C-564
	FCC 15 407	C-581
	ETSI EN 301 893	C-585
	ETSI 300 328	C-589

C-1 ACP
W-CDMA

Table C-1 Standard parameters for ACP function

Standard	Parameter Name	Setting
W-CDMA Uplink	Frequency Span	25 MHz
	RBW	30 kHz
	Detection	RMS
	SWP	Auto, Normal
	Trace Point	1001
	Adjacent Channel Power	On
	ACP Reference	Carrier-1
	Carrier Number	1
	Carrier BW	3.84 MHz
	Carrier Spacing	5 MHz
	In Band Center	Center Frequency
	In Band Filter Type	Root Nyquist
	In Band Roll-off Factor	0.22
	Offset-1 On/Off	On
	Offset-2 On/Off	On
	Offset-3 On/Off	Off
	Offset Freq-1	5 MHz
	Offset Freq-2	10 MHz
	Offset Freq-3	15 MHz
	Ch BW	3.84 MHz
Offset Ch Filter Type	Root Nyquist	
Offset Ch Roll-off Factor	0.22	

Table C-1 Standard parameters for ACP function (Cont'd)

Standard	Parameter Name	Setting
W-CDMA Downlink (Single Carrier)	Frequency Span	25 MHz
	RBW	30 kHz
	Detection	RMS
	SWP	Auto, Normal
	Trace Point	1001
	Adjacent Channel Power	On
	ACP Reference	Carrier-1
	Carrier Number	1
	Carrier BW	3.84 MHz
	Carrier Spacing	5 MHz
	In Band Center	Center Frequency
	In Band Filter Type	Root Nyquist
	In Band Roll-off Factor	0.22
	Offset-1 On/Off	On
	Offset-2 On/Off	On
	Offset-3 On/Off	Off
	Offset Freq-1	5 MHz
	Offset Freq-2	10 MHz
	Offset Freq-3	15 MHz
	Ch BW	3.84 MHz
Offset Ch Filter Type	Root Nyquist	
Offset Ch Roll-off Factor	0.22	

Table C-1 Standard parameters for ACP function (Cont'd)

Standard	Parameter Name	Setting
W-CDMA Downlink (2 Carriers)	Frequency Span	30 MHz
	RBW	30 kHz
	Detection	RMS
	SWP	Auto, Normal
	Trace Point	1001
	Adjacent Channel Power	On
	ACP Reference	Both Sides of Carriers
	Carrier Number	2
	Carrier BW	3.84 MHz
	Carrier Spacing	5 MHz
	In Band Center	Center Frequency
	In Band Filter Type	Root Nyquist
	In Band Roll-off Factor	0.22
	Offset-1 On/Off	On
	Offset-2 On/Off	On
	Offset-3 On/Off	Off
	Offset Freq-1	5 MHz
	Offset Freq-2	10 MHz
	Offset Freq-3	15 MHz
	Ch BW	3.84 MHz
Offset Ch Filter Type	Root Nyquist	
Offset Ch Roll-off Factor	0.22	

Table C-1 Standard parameters for ACP function (Cont'd)

Standard	Parameter Name	Setting
W-CDMA Downlink (3 Carriers)	Frequency Span	35 MHz
	RBW	30 kHz
	Detection	RMS
	SWP	Auto, Normal
	Trace Point	1001
	Adjacent Channel Power	On
	ACP Reference	Both Sides of Carriers
	Carrier Number	3
	Carrier BW	3.84 MHz
	Carrier Spacing	5 MHz
	In Band Center	Center Frequency
	In Band Filter Type	Root Nyquist
	In Band Roll-off Factor	0.22
	Offset-1 On/Off	On
	Offset-2 On/Off	On
	Offset-3 On/Off	Off
	Offset Freq-1	5 MHz
	Offset Freq-2	10 MHz
	Offset Freq-3	15 MHz
	Ch BW	3.84 MHz
Offset Filter Type	Root Nyquist	
Offset Roll-off Factor	0.22	

Table C-1 Standard parameters for ACP function (Cont'd)

Standard	Parameter Name	Setting
W-CDMA Downlink (4 Carriers)	Frequency Span	40 MHz
	RBW	30 kHz
	Detection	RMS
	SWP	Auto, Normal
	Trace Point	1001
	Adjacent Channel Power	On
	ACP Reference	Both Sides of Carriers
	Carrier Number	4
	Carrier BW	3.84 MHz
	Carrier Spacing	5 MHz
	In Band Center	Center Frequency
	In Band Filter Type	Root Nyquist
	In Band Roll-off Factor	0.22
	Offset-1 On/Off	On
	Offset-2 On/Off	On
	Offset-3 On/Off	Off
	Offset Freq-1	5 MHz
	Offset Freq-2	10 MHz
	Offset Freq-3	15 MHz
	Ch BW	3.84 MHz
Offset Filter Type	Root Nyquist	
Offset Roll-off Factor	0.22	

Mobile WiMAX

Table C-1 Standard parameters for ACP function (Cont'd)

Standard	Parameter Name	Setting
Mobile WiMAX DL / UL 10MHz BW	Frequency Span	50 MHz
	RBW	30 kHz
	VBW	100 kHz
	Detection	RMS
	SWP	Auto, Normal
	Trace Point	1001
	Adjacent Channel Power	On
	ACP Reference	Carrier-1
	Carrier Number	1
	Carrier BW	9.5 MHz
	Carrier Spacing	10 MHz
	In Band Center	Center Frequency
	In Band Filter Type	Rect
	Offset-1 On/Off	On
	Offset-2 On/Off	On
	Offset-3 On/Off	Off
	Offset Freq-1	10 MHz
	Offset Freq-2	20 MHz
	Offset Freq-3	30 MHz
	Ch BW	9.5 MHz
Offset Ch Filter Type	Rect	

Table C-1 Standard parameters for ACP function (Cont'd)

Standard	Parameter Name	Setting
Mobile WiMAX DL / UL 5MHz BW	Frequency Span	25 MHz
	RBW	30 kHz
	VBW	100 kHz
	Detection	RMS
	SWP	Auto, Normal
	Trace Point	1001
	Adjacent Channel Power	On
	ACP Reference	Carrier-1
	Carrier Number	1
	Carrier BW	4.75 MHz
	Carrier Spacing	5 MHz
	In Band Center	Center Frequency
	In Band Filter Type	Rect
	Offset-1 On/Off	On
	Offset-2 On/Off	On
	Offset-3 On/Off	Off
	Offset Freq-1	5 MHz
	Offset Freq-2	10 MHz
	Offset Freq-3	15 MHz
	Ch BW	4.75 MHz
Offset Ch Filter Type	Rect	

LTE

Table C-1 Standard parameters for ACP function (Cont'd)

Standard	Parameter Name	Setting
LTE Uplink/Downlink 1.4MHz BW (UTRA 5MHz)	Trace Points	1001
	Span Frequency	21.4 MHz
	RBW	10 kHz
	Detection	RMS
	Sweep Time Switch	Auto
	Auto Sweep Time Select	Normal
	ACP Reference	Carrier Select
	Carrier Number	1
	Carrier BW	1.095 MHz (DL) 1.08 MHz (UL)
	Carrier Spacing	1.4 MHz
	In Band Center	Center Frequency
	In Band Filter Type	Rect
	Offset-1 On/Off	On
	Offset-2 On/Off	On
	Offset-3 On/Off	Off
	Offset Freq-1	3.2 MHz
	Offset Freq-2	8.2 MHz
	Offset Freq-3	13.2 MHz
	Ch BW	3.84 MHz
	Offset Filter Type	Root Nyquist
Offset Roll-off Factor	0.22	

Table C-1 Standard parameters for ACP function (Cont'd)

Standard	Parameter Name	Setting
LTE TDD Uplink/Downlink 1.4MHz BW (UTRA 1.6MHz)	Trace Points	1001
	Span Frequency	7.8 MHz
	RBW	10 kHz
	Detection	RMS
	Sweep Time Switch	Auto
	Auto Sweep Time Select	Normal
	ACP Reference	Carrier Select
	Carrier Number	1
	Carrier BW	1.095 MHz (DL) 1.08 MHz (UL)
	Carrier Spacing	1.4 MHz
	In Band Center	Center Frequency
	In Band Filter Type	Rect
	Offset-1 On/Off	On
	Offset-2 On/Off	On
	Offset-3 On/Off	Off
	Offset Freq-1	1.5 MHz
	Offset Freq-2	3.1 MHz
	Offset Freq-3	4.7 MHz
	Ch BW	1.28 MHz
	Offset Filter Type	Root Nyquist
Offset Roll-off Factor	0.22	
Offset Setting*	Normal	

*: Only Downlink is set for Offset Setting.

Table C-1 Standard parameters for ACP function (Cont'd)

Standard	Parameter Name	Setting
LTE Uplink/Downlink 1.4MHz BW (E-UTRA 1.4MHz)	Trace Points	1001
	Span Frequency	7 MHz
	RBW	10 kHz
	Detection	RMS
	Sweep Time Switch	Auto
	Auto Sweep Time Select	Normal
	ACP Reference	Carrier Select
	Carrier Number	1
	Carrier BW	1.095 MHz (DL) 1.08 MHz (UL)
	Carrier Spacing	1.4 MHz
	In Band Center	Center Frequency
	In Band Filter Type	Rect
	Offset-1 On/Off	On
	Offset-2 On/Off	On
	Offset-3 On/Off	Off
	Offset Freq-1	1.4 MHz
	Offset Freq-2	2.8 MHz
	Offset Freq-3	4.2 MHz
	Ch BW	1.095 MHz (DL) 1.08 MHz (UL)
Offset Filter Type	Rect	

Table C-1 Standard parameters for ACP function (Cont'd)

Standard	Parameter Name	Setting
LTE TDD Uplink/Downlink 1.4MHz BW (E-UTRA 1.4MHz)	Trace Points	1001
	Span Frequency	7 MHz
	RBW	10 kHz
	Detection	RMS
	Sweep Time Switch	Auto
	Auto Sweep Time Select	Normal
	ACP Reference	Carrier Select
	Carrier Number	1
	Carrier BW	1.095 MHz (DL) 1.08 MHz (UL)
	Carrier Spacing	1.4 MHz
	In Band Center	Center Frequency
	In Band Filter Type	Rect
	Offset-1 On/Off	On
	Offset-2 On/Off	On
	Offset-3 On/Off	Off
	Offset Freq-1	1.4 MHz
	Offset Freq-2	2.8 MHz
	Offset Freq-3	4.2 MHz
	Ch BW	1.095 MHz (DL) 1.08 MHz (UL)
	Offset Filter Type	Rect
Offset Setting*	Normal	

*: Only Downlink is set for Offset Setting.

Table C-1 Standard parameters for ACP function (Cont'd)

Standard	Parameter Name	Setting
LTE TDD Downlink 1.4MHz BW (Adv mode)	Trace Points	1001
	Span Frequency	10 MHz
	RBW	10 kHz
	Detection	RMS
	Sweep Time Switch	Auto
	Auto Sweep Time Select	Normal
	ACP Reference	Carrier Select
	Carrier Number	1
	Carrier BW	1.095 MHz
	Carrier Spacing	1.4 MHz
	In Band Center	Center Frequency
	In Band Filter Type	Rect
	Offset Setting	Adv.
	Offset-1 On/Off	On
	Offset-2 On/Off	On
	Offset-3 On/Off	On
	Offset-4 On/Off	On
	Offset-5 On/Off	Off
	Offset-6 On/Off	Off
	Offset-7 On/Off	Off
	Offset-8 On/Off	Off
	Offset Freq-1	1.4 MHz
	Offset Freq-2	2.8 MHz
	Offset Freq-3	1.5 MHz
Offset Freq-4	3.1 MHz	
Offset Freq-5	3.1 MHz	
Offset Freq-6	3.1 MHz	
Offset Freq-7	3.1 MHz	
Offset Freq-8	3.1 MHz	

Table C-1 Standard parameters for ACP function (Cont'd)

Standard	Parameter Name	Setting
LTE TDD Downlink 1.4MHz BW (Adv mode) (Cont'd)	BW Offset-1	1.095 MHz
	BW Offset-2	1.095 MHz
	BW Offset-3	1.28 MHz
	BW Offset-4	1.28 MHz
	BW Offset-5	1.28 MHz
	BW Offset-6	1.28 MHz
	BW Offset-7	1.28 MHz
	BW Offset-8	1.28 MHz
	Offset Filter Type-1	Rect
	Offset Filter Type-2	Rect
	Offset Filter Type-3	Root Nyquist
	Offset Filter Type-4	Root Nyquist
	Offset Filter Type-5	Root Nyquist
	Offset Filter Type-6	Root Nyquist
	Offset Filter Type-7	Root Nyquist
	Offset Filter Type-8	Root Nyquist
	Offset Roll-off Factor-1	0.22
	Offset Roll-off Factor-2	0.22
	Offset Roll-off Factor-3	0.22
	Offset Roll-off Factor-4	0.22
Offset Roll-off Factor-5	0.22	
Offset Roll-off Factor-6	0.22	
Offset Roll-off Factor-7	0.22	
Offset Roll-off Factor-8	0.22	

Table C-1 Standard parameters for ACP function (Cont'd)

Standard	Parameter Name	Setting
LTE Uplink/Downlink 3MHz BW (UTRA 5MHz)	Trace Points	1001
	Span Frequency	23 MHz
	RBW	30 kHz
	Detection	RMS
	Sweep Time Switch	Auto
	Auto Sweep Time Select	Normal
	ACP Reference	Carrier Select
	Carrier Number	1
	Carrier BW	2.715 MHz (DL) 2.7 MHz (UL)
	Carrier Spacing	3 MHz
	In Band Center	Center Frequency
	In Band Filter Type	Rect
	Offset-1 On/Off	On
	Offset-2 On/Off	On
	Offset-3 On/Off	Off
	Offset Freq-1	4 MHz
	Offset Freq-2	9 MHz
	Offset Freq-3	14 MHz
	Ch BW	3.84 MHz
	Offset Filter Type	Root Nyquist
Offset Roll-off Factor	0.22	

Table C-1 Standard parameters for ACP function (Cont'd)

Standard	Parameter Name	Setting
LTE TDD Uplink/Downlink 3MHz BW (UTRA 1.6MHz)	Trace Points	1001
	Span Frequency	9.4 MHz
	RBW	30 kHz
	Detection	RMS
	Sweep Time Switch	Auto
	Auto Sweep Time Select	Normal
	ACP Reference	Carrier Select
	Carrier Number	1
	Carrier BW	2.715 MHz (DL) 2.7 MHz (UL)
	Carrier Spacing	3 MHz
	In Band Center	Center Frequency
	In Band Filter Type	Rect
	Offset-1 On/Off	On
	Offset-2 On/Off	On
	Offset-3 On/Off	Off
	Offset Freq-1	2.3 MHz
	Offset Freq-2	3.9 MHz
	Offset Freq-3	5.5 MHz
	Ch BW	1.28 MHz
	Offset Filter Type	Root Nyquist
Offset Roll-off Factor	0.22	
Offset Setting*	Normal	

*: Only Downlink is set for Offset Setting.

Table C-1 Standard parameters for ACP function (Cont'd)

Standard	Parameter Name	Setting
LTE Uplink/Downlink 3MHz BW (E-UTRA 3MHz)	Trace Points	1001
	Span Frequency	15 MHz
	RBW	30 kHz
	Detection	RMS
	Sweep Time Switch	Auto
	Auto Sweep Time Select	Normal
	ACP Reference	Carrier Select
	Carrier Number	1
	Carrier BW	2.715 MHz (DL) 2.7 MHz (UL)
	Carrier Spacing	3 MHz
	In Band Center	Center Frequency
	In Band Filter Type	Rect
	Offset-1 On/Off	On
	Offset-2 On/Off	On
	Offset-3 On/Off	Off
	Offset Freq-1	3 MHz
	Offset Freq-2	6 MHz
	Offset Freq-3	9 MHz
	Ch BW	2.715 MHz (DL) 2.7 MHz (UL)
Offset Filter Type	Rect	

Table C-1 Standard parameters for ACP function (Cont'd)

Standard	Parameter Name	Setting
LTE TDD Uplink/Downlink 3MHz BW (E-UTRA 3MHz)	Trace Points	1001
	Span Frequency	15 MHz
	RBW	30 kHz
	Detection	RMS
	Sweep Time Switch	Auto
	Auto Sweep Time Select	Normal
	ACP Reference	Carrier Select
	Carrier Number	1
	Carrier BW	2.715 MHz (DL) 2.7 MHz (UL)
	Carrier Spacing	3 MHz
	In Band Center	Center Frequency
	In Band Filter Type	Rect
	Offset-1 On/Off	On
	Offset-2 On/Off	On
	Offset-3 On/Off	Off
	Offset Freq-1	3 MHz
	Offset Freq-2	6 MHz
	Offset Freq-3	9 MHz
	Ch BW	2.715 MHz (DL) 2.7 MHz (UL)
	Offset Filter Type	Rect
Offset Setting*	Normal	

*: Only Downlink is set for Offset Setting.

Table C-1 Standard parameters for ACP function (Cont'd)

Standard	Parameter Name	Setting
LTE TDD Downlink 3MHz BW (Adv mode)	Trace Points	1001
	Span Frequency	20 MHz
	RBW	30 kHz
	Detection	RMS
	Sweep Time Switch	Auto
	Auto Sweep Time Select	Normal
	ACP Reference	Carrier Select
	Carrier Number	1
	Carrier BW	2.715 MHz
	Carrier Spacing	3 MHz
	In Band Center	Center Frequency
	In Band Filter Type	Rect
	Offset Setting	Adv.
	Offset-1 On/Off	On
	Offset-2 On/Off	On
	Offset-3 On/Off	On
	Offset-4 On/Off	On
	Offset-5 On/Off	Off
	Offset-6 On/Off	Off
	Offset-7 On/Off	Off
	Offset-8 On/Off	Off
	Offset Freq-1	3 MHz
	Offset Freq-2	6 MHz
	Offset Freq-3	2.3 MHz
	Offset Freq-4	3.9 MHz
	Offset Freq-5	3.9 MHz
Offset Freq-6	3.9 MHz	
Offset Freq-7	3.9 MHz	
Offset Freq-8	3.9 MHz	

Table C-1 Standard parameters for ACP function (Cont'd)

Standard	Parameter Name	Setting
LTE TDD Downlink 3MHz BW (Adv mode) (Cont'd)	BW Offset-1	4.515 MHz
	BW Offset-2	4.515 MHz
	BW Offset-3	1.28 MHz
	BW Offset-4	1.28 MHz
	BW Offset-5	1.28 MHz
	BW Offset-6	1.28 MHz
	BW Offset-7	1.28 MHz
	BW Offset-8	1.28 MHz
	Offset Filter Type-1	Rect
	Offset Filter Type-2	Rect
	Offset Filter Type-3	Root Nyquist
	Offset Filter Type-4	Root Nyquist
	Offset Filter Type-5	Root Nyquist
	Offset Filter Type-6	Root Nyquist
	Offset Filter Type-7	Root Nyquist
	Offset Filter Type-8	Root Nyquist
	Offset Roll-off Factor-1	0.22
	Offset Roll-off Factor-2	0.22
	Offset Roll-off Factor-3	0.22
	Offset Roll-off Factor-4	0.22
Offset Roll-off Factor-5	0.22	
Offset Roll-off Factor-6	0.22	
Offset Roll-off Factor-7	0.22	
Offset Roll-off Factor-8	0.22	

Table C-1 Standard parameters for ACP function (Cont'd)

Standard	Parameter Name	Setting
LTE Uplink/Downlink 5MHz BW (UTRA 5MHz)	Trace Points	1001
	Span Frequency	25 MHz
	RBW	30 kHz
	Detection	RMS
	Sweep Time Switch	Auto
	Auto Sweep Time Select	Normal
	ACP Reference	Carrier Select
	Carrier Number	1
	Carrier BW	4.515 MHz (DL) 4.5 MHz (UL)
	Carrier Spacing	5 MHz
	In Band Center	Center Frequency
	In Band Filter Type	Rect
	Offset-1 On/Off	On
	Offset-2 On/Off	On
	Offset-3 On/Off	Off
	Offset Freq-1	5 MHz
	Offset Freq-2	10 MHz
	Offset Freq-3	15 MHz
	Ch BW	3.84 MHz
	Offset Filter Type	Root Nyquist
Offset Roll-off Factor	0.22	

Table C-1 Standard parameters for ACP function (Cont'd)

Standard	Parameter Name	Setting
LTE TDD Uplink/Downlink 5MHz BW (UTRA 1.6MHz)	Trace Points	1001
	Span Frequency	11.4 MHz
	RBW	30 kHz
	Detection	RMS
	Sweep Time Switch	Auto
	Auto Sweep Time Select	Normal
	ACP Reference	Carrier Select
	Carrier Number	1
	Carrier BW	4.515 MHz (DL) 4.5 MHz (UL)
	Carrier Spacing	5 MHz
	In Band Center	Center Frequency
	In Band Filter Type	Rect
	Offset-1 On/Off	On
	Offset-2 On/Off	On
	Offset-3 On/Off	Off
	Offset Freq-1	3.3 MHz
	Offset Freq-2	4.9 MHz
	Offset Freq-3	6.5 MHz
	Ch BW	1.28 MHz
	Offset Filter Type	Root Nyquist
Offset Roll-off Factor	0.22	
Offset Setting*	Normal	

*: Only Downlink is set for Offset Setting.

Table C-1 Standard parameters for ACP function (Cont'd)

Standard	Parameter Name	Setting
LTE TDD Downlink 5MHz BW (UTRA 5MHz)	Trace Points	1001
	Span Frequency	25 MHz
	RBW	30 kHz
	Detection	RMS
	Sweep Time Switch	Auto
	Auto Sweep Time Select	Normal
	ACP Reference	Carrier Select
	Carrier Number	1
	Carrier BW	4.515 MHz
	Carrier Spacing	5 MHz
	In Band Center	Center Frequency
	In Band Filter Type	Rect
	Offset-1 On/Off	On
	Offset-2 On/Off	On
	Offset-3 On/Off	Off
	Offset Freq-1	5 MHz
	Offset Freq-2	10 MHz
	Offset Freq-3	15 MHz
	Ch BW	3.84 MHz
	Offset Filter Type	Root Nyquist
Offset Roll-off Factor	0.22	
Offset Setting*	Normal	

*: Only Downlink is set for Offset Setting.

Table C-1 Standard parameters for ACP function (Cont'd)

Standard	Parameter Name	Setting
LTE TDD Downlink 5MHz BW (UTRA 10MHz)	Trace Points	1001
	Span Frequency	45 MHz
	RBW	30 kHz
	Detection	RMS
	Sweep Time Switch	Auto
	Auto Sweep Time Select	Normal
	ACP Reference	Carrier Select
	Carrier Number	1
	Carrier BW	4.515 MHz
	Carrier Spacing	5 MHz
	In Band Center	Center Frequency
	In Band Filter Type	Rect
	Offset-1 On/Off	On
	Offset-2 On/Off	On
	Offset-3 On/Off	Off
	Offset Freq-1	7.5 MHz
	Offset Freq-2	17.5 MHz
	Offset Freq-3	27.5 MHz
	Ch BW	7.68 MHz
	Offset Filter Type	Root Nyquist
Offset Roll-off Factor	0.22	
Offset Setting*	Normal	

*: Only Downlink is set for Offset Setting.

Table C-1 Standard parameters for ACP function (Cont'd)

Standard	Parameter Name	Setting
LTE Uplink/Downlink 5MHz BW (E-UTRA 5MHz)	Trace Points	1001
	Span Frequency	25 MHz
	RBW	30 kHz
	Detection	RMS
	Sweep Time Switch	Auto
	Auto Sweep Time Select	Normal
	ACP Reference	Carrier Select
	Carrier Number	1
	Carrier BW	4.515 MHz (DL) 4.5 MHz (UL)
	Carrier Spacing	5 MHz
	In Band Center	Center Frequency
	In Band Filter Type	Rect
	Offset-1 On/Off	On
	Offset-2 On/Off	On
	Offset-3 On/Off	Off
	Offset Freq-1	5 MHz
	Offset Freq-2	10 MHz
	Offset Freq-3	15 MHz
	Ch BW	4.515 MHz (DL) 4.5 MHz (UL)
Offset Filter Type	Rect	

Table C-1 Standard parameters for ACP function (Cont'd)

Standard	Parameter Name	Setting
LTE TDD Uplink/Downlink 5MHz BW (E-UTRA 5MHz)	Trace Points	1001
	Span Frequency	25 MHz
	RBW	30 kHz
	Detection	RMS
	Sweep Time Switch	Auto
	Auto Sweep Time Select	Normal
	ACP Reference	Carrier Select
	Carrier Number	1
	Carrier BW	4.515 MHz (DL) 4.5 MHz (UL)
	Carrier Spacing	5 MHz
	In Band Center	Center Frequency
	In Band Filter Type	Rect
	Offset-1 On/Off	On
	Offset-2 On/Off	On
	Offset-3 On/Off	Off
	Offset Freq-1	5 MHz
	Offset Freq-2	10 MHz
	Offset Freq-3	15 MHz
	Ch BW	4.515 MHz (DL) 4.5 MHz (UL)
	Offset Filter Type	Rect
Offset Setting*	Normal	

*: Only Downlink is set for Offset Setting.

Table C-1 Standard parameters for ACP function (Cont'd)

Standard	Parameter Name	Setting
LTE TDD Downlink 5MHz BW (Adv mode)	Trace Points	1001
	Span Frequency	45 MHz
	RBW	30 kHz
	Detection	RMS
	Sweep Time Switch	Auto
	Auto Sweep Time Select	Normal
	ACP Reference	Carrier Select
	Carrier Number	1
	Carrier BW	4.515 MHz
	Carrier Spacing	5 MHz
	In Band Center	Center Frequency
	In Band Filter Type	Rect
	Offset Setting	Adv.
	Offset-1 On/Off	On
	Offset-2 On/Off	On
	Offset-3 On/Off	On
	Offset-4 On/Off	On
	Offset-5 On/Off	On
	Offset-6 On/Off	On
	Offset-7 On/Off	On
	Offset-8 On/Off	On
	Offset Freq-1	5 MHz
	Offset Freq-2	10 MHz
	Offset Freq-3	3.3 MHz
Offset Freq-4	4.9 MHz	
Offset Freq-5	5 MHz	
Offset Freq-6	10 MHz	
Offset Freq-7	7.5 MHz	
Offset Freq-8	17.5 MHz	

Table C-1 Standard parameters for ACP function (Cont'd)

Standard	Parameter Name	Setting
LTE TDD Downlink 5MHz BW (Adv mode) (Cont'd)	BW Offset-1	4.515 MHz
	BW Offset-2	4.515 MHz
	BW Offset-3	1.28 MHz
	BW Offset-4	1.28 MHz
	BW Offset-5	3.84 MHz
	BW Offset-6	3.84 MHz
	BW Offset-7	7.68 MHz
	BW Offset-8	7.68 MHz
	Offset Filter Type-1	Rect
	Offset Filter Type-2	Rect
	Offset Filter Type-3	Root Nyquist
	Offset Filter Type-4	Root Nyquist
	Offset Filter Type-5	Root Nyquist
	Offset Filter Type-6	Root Nyquist
	Offset Filter Type-7	Root Nyquist
	Offset Filter Type-8	Root Nyquist
	Offset Roll-off Factor-1	0.22
	Offset Roll-off Factor-2	0.22
	Offset Roll-off Factor-3	0.22
	Offset Roll-off Factor-4	0.22
Offset Roll-off Factor-5	0.22	
Offset Roll-off Factor-6	0.22	
Offset Roll-off Factor-7	0.22	
Offset Roll-off Factor-8	0.22	

Table C-1 Standard parameters for ACP function (Cont'd)

Standard	Parameter Name	Setting
LTE Uplink/Downlink 10MHz BW (UTRA 5MHz)	Trace Points	1001
	Span Frequency	30 MHz
	RBW	30 kHz
	Detection	RMS
	Sweep Time Switch	Auto
	Auto Sweep Time Select	Normal
	ACP Reference	Carrier Select
	Carrier Number	1
	Carrier BW	9.015 MHz (DL) 9 MHz (UL)
	Carrier Spacing	10 MHz
	In Band Center	Center Frequency
	In Band Filter Type	Rect
	Offset-1 On/Off	On
	Offset-2 On/Off	On
	Offset-3 On/Off	Off
	Offset Freq-1	7.5 MHz
	Offset Freq-2	12.5 MHz
	Offset Freq-3	17.5 MHz
	Ch BW	3.84 MHz
	Offset Filter Type	Root Nyquist
Offset Roll-off Factor	0.22	

Table C-1 Standard parameters for ACP function (Cont'd)

Standard	Parameter Name	Setting
LTE TDD Uplink/Downlink 10MHz BW (UTRA 1.6MHz)	Trace Points	1001
	Span Frequency	16.4 MHz
	RBW	30 kHz
	Detection	RMS
	Sweep Time Switch	Auto
	Auto Sweep Time Select	Normal
	ACP Reference	Carrier Select
	Carrier Number	1
	Carrier BW	9.015 MHz (DL) 9 MHz (UL)
	Carrier Spacing	10 MHz
	In Band Center	Center Frequency
	In Band Filter Type	Rect
	Offset-1 On/Off	On
	Offset-2 On/Off	On
	Offset-3 On/Off	Off
	Offset Freq-1	5.8 MHz
	Offset Freq-2	7.4 MHz
	Offset Freq-3	9 MHz
	Ch BW	1.28 MHz
	Offset Filter Type	Root Nyquist
Offset Roll-off Factor	0.22	
Offset Setting*	Normal	

*: Only Downlink is set for Offset Setting.

Table C-1 Standard parameters for ACP function (Cont'd)

Standard	Parameter Name	Setting
LTE TDD Downlink 10MHz BW (UTRA 5MHz)	Trace Points	1001
	Span Frequency	30 MHz
	RBW	30 kHz
	Detection	RMS
	Sweep Time Switch	Auto
	Auto Sweep Time Select	Normal
	ACP Reference	Carrier Select
	Carrier Number	1
	Carrier BW	9.015 MHz
	Carrier Spacing	10 MHz
	In Band Center	Center Frequency
	In Band Filter Type	Rect
	Offset-1 On/Off	On
	Offset-2 On/Off	On
	Offset-3 On/Off	Off
	Offset Freq-1	7.5 MHz
	Offset Freq-2	12.5 MHz
	Offset Freq-3	17.5 MHz
	Ch BW	3.84 MHz
	Offset Filter Type	Root Nyquist
Offset Roll-off Factor	0.22	
Offset Setting*	Normal	

*: Only Downlink is set for Offset Setting.

Table C-1 Standard parameters for ACP function (Cont'd)

Standard	Parameter Name	Setting
LTE TDD Downlink 10MHz BW (UTRA 10MHz)	Trace Points	1001
	Span Frequency	50 MHz
	RBW	30 kHz
	Detection	RMS
	Sweep Time Switch	Auto
	Auto Sweep Time Select	Normal
	ACP Reference	Carrier Select
	Carrier Number	1
	Carrier BW	9.015 MHz
	Carrier Spacing	10 MHz
	In Band Center	Center Frequency
	In Band Filter Type	Rect
	Offset-1 On/Off	On
	Offset-2 On/Off	On
	Offset-3 On/Off	Off
	Offset Freq-1	10 MHz
	Offset Freq-2	20 MHz
	Offset Freq-3	30 MHz
	Ch BW	7.68 MHz
	Offset Filter Type	Root Nyquist
Offset Roll-off Factor	0.22	
Offset Setting*	Normal	

*: Only Downlink is set for Offset Setting.

Table C-1 Standard parameters for ACP function (Cont'd)

Standard	Parameter Name	Setting
LTE Uplink/Downlink 10MHz BW (E-UTRA 10MHz)	Trace Points	1001
	Span Frequency	50 MHz
	RBW	100 kHz
	Detection	RMS
	Sweep Time Switch	Auto
	Auto Sweep Time Select	Normal
	ACP Reference	Carrier Select
	Carrier Number	1
	Carrier BW	9.015 MHz (DL) 9 MHz (UL)
	Carrier Spacing	10 MHz
	In Band Center	Center Frequency
	In Band Filter Type	Rect
	Offset-1 On/Off	On
	Offset-2 On/Off	On
	Offset-3 On/Off	Off
	Offset Freq-1	10 MHz
	Offset Freq-2	20 MHz
	Offset Freq-3	30 MHz
	Ch BW	9.015 MHz (DL) 9 MHz (UL)
Offset Filter Type	Rect	

Table C-1 Standard parameters for ACP function (Cont'd)

Standard	Parameter Name	Setting
LTE TDD Uplink/Downlink 10MHz BW (E-UTRA 10MHz)	Trace Points	1001
	Span Frequency	50 MHz
	RBW	30 kHz
	Detection	RMS
	Sweep Time Switch	Auto
	Auto Sweep Time Select	Normal
	ACP Reference	Carrier Select
	Carrier Number	1
	Carrier BW	9.015 MHz (DL) 9 MHz (UL)
	Carrier Spacing	10 MHz
	In Band Center	Center Frequency
	In Band Filter Type	Rect
	Offset-1 On/Off	On
	Offset-2 On/Off	On
	Offset-3 On/Off	Off
	Offset Freq-1	10 MHz
	Offset Freq-2	20 MHz
	Offset Freq-3	30 MHz
	Ch BW	9.015 MHz (DL) 9 MHz (UL)
	Offset Filter Type	Rect
Offset Setting*	Normal	

*: Only Downlink is set for Offset Setting.

Table C-1 Standard parameters for ACP function (Cont'd)

Standard	Parameter Name	Setting
LTE TDD Downlink 10MHz BW (Adv mode)	Trace Points	1001
	Span Frequency	50 MHz
	RBW	30 kHz
	Detection	RMS
	Sweep Time Switch	Auto
	Auto Sweep Time Select	Normal
	ACP Reference	Carrier Select
	Carrier Number	1
	Carrier BW	9.015 MHz
	Carrier Spacing	10 MHz
	In Band Center	Center Frequency
	In Band Filter Type	Rect
	Offset Setting	Adv.
	Offset-1 On/Off	On
	Offset-2 On/Off	On
	Offset-3 On/Off	On
	Offset-4 On/Off	On
	Offset-5 On/Off	On
	Offset-6 On/Off	On
	Offset-7 On/Off	On
	Offset-8 On/Off	On
	Offset Freq-1	10 MHz
	Offset Freq-2	20 MHz
	Offset Freq-3	5.8 MHz
Offset Freq-4	7.4 MHz	
Offset Freq-5	7.5 MHz	
Offset Freq-6	12.5 MHz	
Offset Freq-7	10 MHz	
Offset Freq-8	20 MHz	

Table C-1 Standard parameters for ACP function (Cont'd)

Standard	Parameter Name	Setting
LTE TDD Downlink 10MHz BW (Adv mode) (Cont'd)	BW Offset-1	9.015 MHz
	BW Offset-2	9.015 MHz
	BW Offset-3	1.28 MHz
	BW Offset-4	1.28 MHz
	BW Offset-5	3.84 MHz
	BW Offset-6	3.84 MHz
	BW Offset-7	7.68 MHz
	BW Offset-8	7.68 MHz
	Offset Filter Type-1	Rect
	Offset Filter Type-2	Rect
	Offset Filter Type-3	Root Nyquist
	Offset Filter Type-4	Root Nyquist
	Offset Filter Type-5	Root Nyquist
	Offset Filter Type-6	Root Nyquist
	Offset Filter Type-7	Root Nyquist
	Offset Filter Type-8	Root Nyquist
	Offset Roll-off Factor-1	0.22
	Offset Roll-off Factor-2	0.22
	Offset Roll-off Factor-3	0.22
	Offset Roll-off Factor-4	0.22
Offset Roll-off Factor-5	0.22	
Offset Roll-off Factor-6	0.22	
Offset Roll-off Factor-7	0.22	
Offset Roll-off Factor-8	0.22	

Table C-1 Standard parameters for ACP function (Cont'd)

Standard	Parameter Name	Setting
LTE Uplink/Downlink 15MHz BW (UTRA 5MHz)	Trace Points	1001
	Span Frequency	35 MHz
	RBW	30 kHz
	Detection	RMS
	Sweep Time Switch	Auto
	Auto Sweep Time Select	Normal
	ACP Reference	Carrier Select
	Carrier Number	1
	Carrier BW	13.515 MHz (DL) 13.5 MHz (UL)
	Carrier Spacing	15 MHz
	In Band Center	Center Frequency
	In Band Filter Type	Rect
	Offset-1 On/Off	On
	Offset-2 On/Off	On
	Offset-3 On/Off	Off
	Offset Freq-1	10 MHz
	Offset Freq-2	15 MHz
	Offset Freq-3	20 MHz
	Ch BW	3.84 MHz
	Offset Filter Type	Root Nyquist
Offset Roll-off Factor	0.22	

Table C-1 Standard parameters for ACP function (Cont'd)

Standard	Parameter Name	Setting
LTE TDD Uplink/Downlink 15MHz BW (UTRA 1.6MHz)	Trace Points	1001
	Span Frequency	21.4 MHz
	RBW	30 kHz
	Detection	RMS
	Sweep Time Switch	Auto
	Auto Sweep Time Select	Normal
	ACP Reference	Carrier Select
	Carrier Number	1
	Carrier BW	13.515 MHz (DL) 13.5 MHz (UL)
	Carrier Spacing	15 MHz
	In Band Center	Center Frequency
	In Band Filter Type	Rect
	Offset-1 On/Off	On
	Offset-2 On/Off	On
	Offset-3 On/Off	Off
	Offset Freq-1	8.3 MHz
	Offset Freq-2	9.9 MHz
	Offset Freq-3	11.5 MHz
	Ch BW	1.28 MHz
	Offset Filter Type	Root Nyquist
Offset Roll-off Factor	0.22	
Offset Setting*	Normal	

*: Only Downlink is set for Offset Setting.

Table C-1 Standard parameters for ACP function (Cont'd)

Standard	Parameter Name	Setting
LTE TDD Downlink 15MHz BW (UTRA 5MHz)	Trace Points	1001
	Span Frequency	35 MHz
	RBW	30 kHz
	Detection	RMS
	Sweep Time Switch	Auto
	Auto Sweep Time Select	Normal
	ACP Reference	Carrier Select
	Carrier Number	1
	Carrier BW	13.515 MHz
	Carrier Spacing	15 MHz
	In Band Center	Center Frequency
	In Band Filter Type	Rect
	Offset-1 On/Off	On
	Offset-2 On/Off	On
	Offset-3 On/Off	Off
	Offset Freq-1	10 MHz
	Offset Freq-2	15 MHz
	Offset Freq-3	20 MHz
	Ch BW	3.84 MHz
	Offset Filter Type	Root Nyquist
Offset Roll-off Factor	0.22	
Offset Setting*	Normal	

*: Only Downlink is set for Offset Setting.

Table C-1 Standard parameters for ACP function (Cont'd)

Standard	Parameter Name	Setting
LTE TDD Downlink 15MHz BW (UTRA 10MHz)	Trace Points	1001
	Span Frequency	55 MHz
	RBW	30 kHz
	Detection	RMS
	Sweep Time Switch	Auto
	Auto Sweep Time Select	Normal
	ACP Reference	Carrier Select
	Carrier Number	1
	Carrier BW	13.515 MHz
	Carrier Spacing	15 MHz
	In Band Center	Center Frequency
	In Band Filter Type	Rect
	Offset-1 On/Off	On
	Offset-2 On/Off	On
	Offset-3 On/Off	Off
	Offset Freq-1	12.5 MHz
	Offset Freq-2	22.5 MHz
	Offset Freq-3	32.5 MHz
	Ch BW	7.68 MHz
	Offset Filter Type	Root Nyquist
Offset Roll-off Factor	0.22	
Offset Setting*	Normal	

*: Only Downlink is set for Offset Setting.

Table C-1 Standard parameters for ACP function (Cont'd)

Standard	Parameter Name	Setting
LTE Uplink/Downlink 15MHz BW (E-UTRA 15MHz)	Trace Points	1001
	Span Frequency	75 MHz
	RBW	100 kHz
	Detection	RMS
	Sweep Time Switch	Auto
	Auto Sweep Time Select	Normal
	ACP Reference	Carrier Select
	Carrier Number	1
	Carrier BW	13.515 MHz (DL) 13.5 MHz (UL)
	Carrier Spacing	15 MHz
	In Band Center	Center Frequency
	In Band Filter Type	Rect
	Offset-1 On/Off	On
	Offset-2 On/Off	On
	Offset-3 On/Off	Off
	Offset Freq-1	15 MHz
	Offset Freq-2	30 MHz
	Offset Freq-3	45 MHz
	Ch BW	13.515 MHz (DL) 13.5 MHz (UL)
Offset Filter Type	Rect	

Table C-1 Standard parameters for ACP function (Cont'd)

Standard	Parameter Name	Setting
LTE TDD Uplink/Downlink 15MHz BW (E-UTRA 15MHz)	Trace Points	1001
	Span Frequency	75 MHz
	RBW	30 kHz
	Detection	RMS
	Sweep Time Switch	Auto
	Auto Sweep Time Select	Normal
	ACP Reference	Carrier Select
	Carrier Number	1
	Carrier BW	13.515 MHz (DL) 13.5 MHz (UL)
	Carrier Spacing	15 MHz
	In Band Center	Center Frequency
	In Band Filter Type	Rect
	Offset-1 On/Off	On
	Offset-2 On/Off	On
	Offset-3 On/Off	Off
	Offset Freq-1	15 MHz
	Offset Freq-2	30 MHz
	Offset Freq-3	45 MHz
	Ch BW	13.515 MHz (DL) 13.5 MHz (UL)
	Offset Filter Type	Rect
Offset Setting*	Normal	

*: Only Downlink is set for Offset Setting.

Table C-1 Standard parameters for ACP function (Cont'd)

Standard	Parameter Name	Setting
LTE TDD Downlink 15MHz BW (Adv mode)	Trace Points	1001
	Span Frequency	75 MHz
	RBW	30 kHz
	Detection	RMS
	Sweep Time Switch	Auto
	Auto Sweep Time Select	Normal
	ACP Reference	Carrier Select
	Carrier Number	1
	Carrier BW	13.515 MHz
	Carrier Spacing	15 MHz
	In Band Center	Center Frequency
	In Band Filter Type	Rect
	Offset Setting	Adv.
	Offset-1 On/Off	On
	Offset-2 On/Off	On
	Offset-3 On/Off	On
	Offset-4 On/Off	On
	Offset-5 On/Off	On
	Offset-6 On/Off	On
	Offset-7 On/Off	On
	Offset-8 On/Off	On
	Offset Freq-1	15 MHz
	Offset Freq-2	30 MHz
	Offset Freq-3	8.3 MHz
	Offset Freq-4	9.9 MHz
	Offset Freq-5	10 MHz
Offset Freq-6	15 MHz	
Offset Freq-7	12.5 MHz	
Offset Freq-8	22.5 MHz	

Table C-1 Standard parameters for ACP function (Cont'd)

Standard	Parameter Name	Setting
LTE TDD Downlink 15MHz BW (Adv mode) (Cont'd)	BW Offset-1	13.515 MHz
	BW Offset-2	13.515 MHz
	BW Offset-3	1.28 MHz
	BW Offset-4	1.28 MHz
	BW Offset-5	3.84 MHz
	BW Offset-6	3.84 MHz
	BW Offset-7	7.68 MHz
	BW Offset-8	7.68 MHz
	Offset Filter Type-1	Rect
	Offset Filter Type-2	Rect
	Offset Filter Type-3	Root Nyquist
	Offset Filter Type-4	Root Nyquist
	Offset Filter Type-5	Root Nyquist
	Offset Filter Type-6	Root Nyquist
	Offset Filter Type-7	Root Nyquist
	Offset Filter Type-8	Root Nyquist
	Offset Roll-off Factor-1	0.22
	Offset Roll-off Factor-2	0.22
	Offset Roll-off Factor-3	0.22
	Offset Roll-off Factor-4	0.22
Offset Roll-off Factor-5	0.22	
Offset Roll-off Factor-6	0.22	
Offset Roll-off Factor-7	0.22	
Offset Roll-off Factor-8	0.22	

Table C-1 Standard parameters for ACP function (Cont'd)

Standard	Parameter Name	Setting
LTE Uplink/Downlink 20MHz BW (UTRA 5MHz)	Trace Points	1001
	Span Frequency	40 MHz
	RBW	30 kHz
	Detection	RMS
	Sweep Time Switch	Auto
	Auto Sweep Time Select	Normal
	ACP Reference	Carrier Select
	Carrier Number	1
	Carrier BW	18.015 MHz (DL) 18 MHz (UL)
	Carrier Spacing	20 MHz
	In Band Center	Center Frequency
	In Band Filter Type	Rect
	Offset-1 On/Off	On
	Offset-2 On/Off	On
	Offset-3 On/Off	Off
	Offset Freq-1	12.5 MHz
	Offset Freq-2	17.5 MHz
	Offset Freq-3	22.5 MHz
	Ch BW	3.84 MHz
	Offset Filter Type	Root Nyquist
Offset Roll-off Factor	0.22	

Table C-1 Standard parameters for ACP function (Cont'd)

Standard	Parameter Name	Setting
LTE TDD Uplink/Downlink 20MHz BW (UTRA 1.6MHz)	Trace Points	1001
	Span Frequency	26.4 MHz
	RBW	30 kHz
	Detection	RMS
	Sweep Time Switch	Auto
	Auto Sweep Time Select	Normal
	ACP Reference	Carrier Select
	Carrier Number	1
	Carrier BW	18.015 MHz (DL) 18 MHz (UL)
	Carrier Spacing	20 MHz
	In Band Center	Center Frequency
	In Band Filter Type	Rect
	Offset-1 On/Off	On
	Offset-2 On/Off	On
	Offset-3 On/Off	Off
	Offset Freq-1	10.8 MHz
	Offset Freq-2	12.4 MHz
	Offset Freq-3	14 MHz
	Ch BW	1.28 MHz
	Offset Filter Type	Root Nyquist
Offset Roll-off Factor	0.22	
Offset Setting*	Normal	

*: Only Downlink is set for Offset Setting.

Table C-1 Standard parameters for ACP function (Cont'd)

Standard	Parameter Name	Setting
LTE TDD Downlink 20MHz BW (UTRA 5MHz)	Trace Points	1001
	Span Frequency	40 MHz
	RBW	30 kHz
	Detection	RMS
	Sweep Time Switch	Auto
	Auto Sweep Time Select	Normal
	ACP Reference	Carrier Select
	Carrier Number	1
	Carrier BW	18.015 MHz
	Carrier Spacing	20 MHz
	In Band Center	Center Frequency
	In Band Filter Type	Rect
	Offset-1 On/Off	On
	Offset-2 On/Off	On
	Offset-3 On/Off	Off
	Offset Freq-1	12.5 MHz
	Offset Freq-2	17.5 MHz
	Offset Freq-3	22.5 MHz
	Ch BW	3.84 MHz
	Offset Filter Type	Root Nyquist
Offset Roll-off Factor	0.22	
Offset Setting*	Normal	

*: Only Downlink is set for Offset Setting.

Table C-1 Standard parameters for ACP function (Cont'd)

Standard	Parameter Name	Setting
LTE TDD Downlink 20MHz BW (UTRA 10MHz)	Trace Points	1001
	Span Frequency	60 MHz
	RBW	30 kHz
	Detection	RMS
	Sweep Time Switch	Auto
	Auto Sweep Time Select	Normal
	ACP Reference	Carrier Select
	Carrier Number	1
	Carrier BW	18.015 MHz
	Carrier Spacing	20 MHz
	In Band Center	Center Frequency
	In Band Filter Type	Rect
	Offset-1 On/Off	On
	Offset-2 On/Off	On
	Offset-3 On/Off	Off
	Offset Freq-1	15 MHz
	Offset Freq-2	25 MHz
	Offset Freq-3	35 MHz
	Ch BW	7.68 MHz
	Offset Filter Type	Root Nyquist
Offset Roll-off Factor	0.22	
Offset Setting*	Normal	

*: Only Downlink is set for Offset Setting.

Table C-1 Standard parameters for ACP function (Cont'd)

Standard	Parameter Name	Setting
LTE Uplink/Downlink 20MHz BW (E-UTRA 20MHz)	Trace Points	1001
	Span Frequency	100 MHz
	RBW	100 kHz
	Detection	RMS
	Sweep Time Switch	Auto
	Auto Sweep Time Select	Normal
	ACP Reference	Carrier Select
	Carrier Number	1
	Carrier BW	18.015 MHz (DL) 18 MHz (UL)
	Carrier Spacing	20 MHz
	In Band Center	Center Frequency
	In Band Filter Type	Rect
	Offset-1 On/Off	On
	Offset-2 On/Off	On
	Offset-3 On/Off	Off
	Offset Freq-1	20 MHz
	Offset Freq-2	40 MHz
	Offset Freq-3	60 MHz
	Ch BW	18.015 MHz (DL) 18 MHz (UL)
Offset Filter Type	Rect	

Table C-1 Standard parameters for ACP function (Cont'd)

Standard	Parameter Name	Setting
LTE TDD Uplink/Downlink 20MHz BW (E-UTRA 20MHz)	Trace Points	1001
	Span Frequency	100 MHz
	RBW	30 kHz
	Detection	RMS
	Sweep Time Switch	Auto
	Auto Sweep Time Select	Normal
	ACP Reference	Carrier Select
	Carrier Number	1
	Carrier BW	18.015 MHz (DL) 18 MHz (UL)
	Carrier Spacing	20 MHz
	In Band Center	Center Frequency
	In Band Filter Type	Rect
	Offset-1 On/Off	On
	Offset-2 On/Off	On
	Offset-3 On/Off	Off
	Offset Freq-1	20 MHz
	Offset Freq-2	40 MHz
	Offset Freq-3	60 MHz
	Ch BW	18.015 MHz (DL) 18 MHz (UL)
	Offset Filter Type	Rect
Offset Setting*	Normal	

*: Only Downlink is set for Offset Setting.

Table C-1 Standard parameters for ACP function (Cont'd)

Standard	Parameter Name	Setting
LTE TDD Downlink 20MHz BW (Adv mode)	Trace Points	1001
	Span Frequency	100 MHz
	RBW	30 kHz
	Detection	RMS
	Sweep Time Switch	Auto
	Auto Sweep Time Select	Normal
	ACP Reference	Carrier Select
	Carrier Number	1
	Carrier BW	18.015 MHz
	Carrier Spacing	20 MHz
	In Band Center	Center Frequency
	In Band Filter Type	Rect
	Offset Setting	Adv.
	Offset-1 On/Off	On
	Offset-2 On/Off	On
	Offset-3 On/Off	On
	Offset-4 On/Off	On
	Offset-5 On/Off	On
	Offset-6 On/Off	On
	Offset-7 On/Off	On
	Offset-8 On/Off	On
	Offset Freq-1	20 MHz
	Offset Freq-2	40 MHz
	Offset Freq-3	10.8 MHz
	Offset Freq-4	12.4 MHz
	Offset Freq-5	12.5 MHz
Offset Freq-6	17.5 MHz	
Offset Freq-7	15 MHz	
Offset Freq-8	25 MHz	

Table C-1 Standard parameters for ACP function (Cont'd)

Standard	Parameter Name	Setting
LTE TDD Downlink 20MHz BW (Adv mode) (Cont'd)	BW Offset-1	18.015 MHz
	BW Offset-2	18.015 MHz
	BW Offset-3	1.28 MHz
	BW Offset-4	1.28 MHz
	BW Offset-5	3.84 MHz
	BW Offset-6	3.84 MHz
	BW Offset-7	7.68 MHz
	BW Offset-8	7.68 MHz
	Offset Filter Type-1	Rect
	Offset Filter Type-2	Rect
	Offset Filter Type-3	Root Nyquist
	Offset Filter Type-4	Root Nyquist
	Offset Filter Type-5	Root Nyquist
	Offset Filter Type-6	Root Nyquist
	Offset Filter Type-7	Root Nyquist
	Offset Filter Type-8	Root Nyquist
	Offset Roll-off Factor-1	0.22
	Offset Roll-off Factor-2	0.22
	Offset Roll-off Factor-3	0.22
	Offset Roll-off Factor-4	0.22
Offset Roll-off Factor-5	0.22	
Offset Roll-off Factor-6	0.22	
Offset Roll-off Factor-7	0.22	
Offset Roll-off Factor-8	0.22	

DSRC

Table C-1 Standard parameters for ACP function (Cont'd)

Standard	Parameter Name	Setting
DSRC $\pi/4$ DQPSK	Trace Points	1001
	Span Frequency	25 MHz
	RBW	30 kHz
	VBW	100 kHz
	VBW Mode	Power
	Detection	Positive
	Sweep Time Freq. Domain	7.1 s
	Auto Sweep Time Select	Normal
	ACP Reference	Carrier Select
	Carrier Number	1
	Carrier BW	4.4 MHz
	Carrier Spacing	5 MHz
	In Band Center	Center Frequency
	In Band Filter Type	Rect
	Offset-1 On/Off	On
	Offset-2 On/Off	On
	Offset-3 On/Off	Off
	Offset Freq-1	5 MHz
	Offset Freq-2	10 MHz
	Offset Freq-3	15 MHz
Ch BW	4.4 MHz	
Offset Filter Type	Rect	

Table C-1 Standard parameters for ACP function (Cont'd)

Standard	Parameter Name	Setting
DSRC ASK	Trace Points	1001
	Span Frequency	25 MHz
	RBW	30 kHz
	VBW	100 kHz
	VBW Mode	Power
	Detection	Positive
	Sweep Time Freq. Domain	7.1 s
	Auto Sweep Time Select	Normal
	ACP Reference	Carrier Select
	Carrier Number	1
	Carrier BW	4.4 MHz
	Carrier Spacing	5 MHz
	In Band Center	Center Frequency
	In Band Filter Type	Rect
	Offset-1 On/Off	On
	Offset-2 On/Off	On
	Offset-3 On/Off	Off
	Offset Freq-1	5 MHz
	Offset Freq-2	10 MHz
	Offset Freq-3	15 MHz
Ch BW	4.4 MHz	
Offset Filter Type	Rect	

TD-SCDMA

Table C-1 Standard parameters for ACP function (Cont'd)

Standard	Parameter Name	Setting
TD-SCDMA (Single Carrier)	Trace Points	1001
	Span Frequency	8 MHz
	RBW	30 kHz
	Detection	RMS
	Sweep Time Switch	Manual
	Sweep Time Freq. Domain	676 ms
	Auto Sweep Time Select	Normal
	ACP Reference	Carrier Select
	Carrier Number	1
	Carrier BW	1.28 MHz
	Carrier Spacing	1.6 MHz
	In Band Center	Center Frequency
	In Band Filter Type	Rect
	Offset-1 On/Off	On
	Offset-2 On/Off	On
	Offset-3 On/Off	Off
	Offset Freq-1	1.6 MHz
	Offset Freq-2	3.2 MHz
	Offset Freq-3	4.8 MHz
	Ch BW	1.28 MHz
Offset Filter Type	Root Nyquist	
Offset Roll-off Factor	0.22	

Table C-1 Standard parameters for ACP function (Cont'd)

Standard	Parameter Name	Setting
TD-SCDMA (2 Carriers)	Trace Points	1001
	Span Frequency	10 MHz
	RBW	30 kHz
	Detection	RMS
	Sweep Time Switch	Manual
	Sweep Time Freq. Domain	676 ms
	Auto Sweep Time Select	Normal
	ACP Reference	Carrier Select
	Carrier Number	2
	Carrier BW	1.28 MHz
	Carrier Spacing	1.6 MHz
	In Band Center	Center Frequency
	In Band Filter Type	Rect
	Offset-1 On/Off	On
	Offset-2 On/Off	On
	Offset-3 On/Off	Off
	Offset Freq-1	1.6 MHz
	Offset Freq-2	3.2 MHz
	Offset Freq-3	4.8 MHz
	Ch BW	1.28 MHz
Offset Filter Type	Root Nyquist	
Offset Roll-off Factor	0.22	

Table C-1 Standard parameters for ACP function (Cont'd)

Standard	Parameter Name	Setting
TD-SCDMA (3 Carriers)	Trace Points	1001
	Span Frequency	12 MHz
	RBW	30 kHz
	Detection	RMS
	Sweep Time Switch	Manual
	Sweep Time Freq. Domain	676 ms
	Auto Sweep Time Select	Normal
	ACP Reference	Carrier Select
	Carrier Number	3
	Carrier BW	1.28 MHz
	Carrier Spacing	1.6 MHz
	In Band Center	Center Frequency
	In Band Filter Type	Rect
	Offset-1 On/Off	On
	Offset-2 On/Off	On
	Offset-3 On/Off	Off
	Offset Freq-1	1.6 MHz
	Offset Freq-2	3.2 MHz
	Offset Freq-3	4.8 MHz
	Ch BW	1.28 MHz
Offset Filter Type	Root Nyquist	
Offset Roll-off Factor	0.22	

Table C-1 Standard parameters for ACP function (Cont'd)

Standard	Parameter Name	Setting
TD-SCDMA (4 Carriers)	Trace Points	1001
	Span Frequency	13 MHz
	RBW	30 kHz
	Detection	RMS
	Sweep Time Switch	Manual
	Sweep Time Freq. Domain	676 ms
	Auto Sweep Time Select	Normal
	ACP Reference	Carrier Select
	Carrier Number	4
	Carrier BW	1.28 MHz
	Carrier Spacing	1.6 MHz
	In Band Center	Center Frequency
	In Band Filter Type	Rect
	Offset-1 On/Off	On
	Offset-2 On/Off	On
	Offset-3 On/Off	Off
	Offset Freq-1	1.6 MHz
	Offset Freq-2	3.2 MHz
	Offset Freq-3	4.8 MHz
	Ch BW	1.28 MHz
Offset Filter Type	Root Nyquist	
Offset Roll-off Factor	0.22	

Table C-1 Standard parameters for ACP function (Cont'd)

Standard	Parameter Name	Setting
TD-SCDMA (5 Carriers)	Trace Points	1001
	Span Frequency	15 MHz
	RBW	30 kHz
	Detection	RMS
	Sweep Time Switch	Manual
	Sweep Time Freq. Domain	676 ms
	Auto Sweep Time Select	Normal
	ACP Reference	Carrier Select
	Carrier Number	5
	Carrier BW	1.28 MHz
	Carrier Spacing	1.6 MHz
	In Band Center	Center Frequency
	In Band Filter Type	Rect
	Offset-1 On/Off	On
	Offset-2 On/Off	On
	Offset-3 On/Off	Off
	Offset Freq-1	1.6 MHz
	Offset Freq-2	3.2 MHz
	Offset Freq-3	4.8 MHz
	Ch BW	1.28 MHz
Offset Filter Type	Root Nyquist	
Offset Roll-off Factor	0.22	

Table C-1 Standard parameters for ACP function (Cont'd)

Standard	Parameter Name	Setting
TD-SCDMA (6 Carriers)	Trace Points	1001
	Span Frequency	16 MHz
	RBW	30 kHz
	Detection	RMS
	Sweep Time Switch	Manual
	Sweep Time Freq. Domain	676 ms
	Auto Sweep Time Select	Normal
	ACP Reference	Carrier Select
	Carrier Number	6
	Carrier BW	1.28 MHz
	Carrier Spacing	1.6 MHz
	In Band Center	Center Frequency
	In Band Filter Type	Rect
	Offset-1 On/Off	On
	Offset-2 On/Off	On
	Offset-3 On/Off	Off
	Offset Freq-1	1.6 MHz
	Offset Freq-2	3.2 MHz
	Offset Freq-3	4.8 MHz
	Ch BW	1.28 MHz
Offset Filter Type	Root Nyquist	
Offset Roll-off Factor	0.22	

Table C-1 Standard parameters for ACP function (Cont'd)

Standard	Parameter Name	Setting
TD-SCDMA (7 Carriers)	Trace Points	1001
	Span Frequency	18 MHz
	RBW	30 kHz
	Detection	RMS
	Sweep Time Switch	Manual
	Sweep Time Freq. Domain	676 ms
	Auto Sweep Time Select	Normal
	ACP Reference	Carrier Select
	Carrier Number	7
	Carrier BW	1.28 MHz
	Carrier Spacing	1.6 MHz
	In Band Center	Center Frequency
	In Band Filter Type	Rect
	Offset-1 On/Off	On
	Offset-2 On/Off	On
	Offset-3 On/Off	Off
	Offset Freq-1	1.6 MHz
	Offset Freq-2	3.2 MHz
	Offset Freq-3	4.8 MHz
	Ch BW	1.28 MHz
Offset Filter Type	Root Nyquist	
Offset Roll-off Factor	0.22	

Table C-1 Standard parameters for ACP function (Cont'd)

Standard	Parameter Name	Setting
TD-SCDMA (8 Carriers)	Trace Points	1001
	Span Frequency	20 MHz
	RBW	30 kHz
	Detection	RMS
	Sweep Time Switch	Manual
	Sweep Time Freq. Domain	676 ms
	Auto Sweep Time Select	Normal
	ACP Reference	Carrier Select
	Carrier Number	8
	Carrier BW	1.28 MHz
	Carrier Spacing	1.6 MHz
	In Band Center	Center Frequency
	In Band Filter Type	Rect
	Offset-1 On/Off	On
	Offset-2 On/Off	On
	Offset-3 On/Off	Off
	Offset Freq-1	1.6 MHz
	Offset Freq-2	3.2 MHz
	Offset Freq-3	4.8 MHz
	Ch BW	1.28 MHz
Offset Filter Type	Root Nyquist	
Offset Roll-off Factor	0.22	

Table C-1 Standard parameters for ACP function (Cont'd)

Standard	Parameter Name	Setting
TD-SCDMA (9 Carriers)	Trace Points	1001
	Span Frequency	21 MHz
	RBW	30 kHz
	Detection	RMS
	Sweep Time Switch	Manual
	Sweep Time Freq. Domain	676 ms
	Auto Sweep Time Select	Normal
	ACP Reference	Carrier Select
	Carrier Number	9
	Carrier BW	1.28 MHz
	Carrier Spacing	1.6 MHz
	In Band Center	Center Frequency
	In Band Filter Type	Rect
	Offset-1 On/Off	On
	Offset-2 On/Off	On
	Offset-3 On/Off	Off
	Offset Freq-1	1.6 MHz
	Offset Freq-2	3.2 MHz
	Offset Freq-3	4.8 MHz
	Ch BW	1.28 MHz
Offset Filter Type	Root Nyquist	
Offset Roll-off Factor	0.22	

Table C-1 Standard parameters for ACP function (Cont'd)

Standard	Parameter Name	Setting
TD-SCDMA (10 Carriers)	Trace Points	1001
	Span Frequency	23 MHz
	RBW	30 kHz
	Detection	RMS
	Sweep Time Switch	Manual
	Sweep Time Freq. Domain	676 ms
	Auto Sweep Time Select	Normal
	ACP Reference	Carrier Select
	Carrier Number	10
	Carrier BW	1.28 MHz
	Carrier Spacing	1.6 MHz
	In Band Center	Center Frequency
	In Band Filter Type	Rect
	Offset-1 On/Off	On
	Offset-2 On/Off	On
	Offset-3 On/Off	Off
	Offset Freq-1	1.6 MHz
	Offset Freq-2	3.2 MHz
	Offset Freq-3	4.8 MHz
	Ch BW	1.28 MHz
Offset Filter Type	Root Nyquist	
Offset Roll-off Factor	0.22	

Table C-1 Standard parameters for ACP function (Cont'd)

Standard	Parameter Name	Setting
TD-SCDMA (11 Carriers)	Trace Points	1001
	Span Frequency	25 MHz
	RBW	30 kHz
	Detection	RMS
	Sweep Time Switch	Manual
	Sweep Time Freq. Domain	676 ms
	Auto Sweep Time Select	Normal
	ACP Reference	Carrier Select
	Carrier Number	11
	Carrier BW	1.28 MHz
	Carrier Spacing	1.6 MHz
	In Band Center	Center Frequency
	In Band Filter Type	Rect
	Offset-1 On/Off	On
	Offset-2 On/Off	On
	Offset-3 On/Off	Off
	Offset Freq-1	1.6 MHz
	Offset Freq-2	3.2 MHz
	Offset Freq-3	4.8 MHz
	Ch BW	1.28 MHz
Offset Filter Type	Root Nyquist	
Offset Roll-off Factor	0.22	

Table C-1 Standard parameters for ACP function (Cont'd)

Standard	Parameter Name	Setting
TD-SCDMA (12 Carriers)	Trace Points	1001
	Span Frequency	26 MHz
	RBW	30 kHz
	Detection	RMS
	Sweep Time Switch	Manual
	Sweep Time Freq. Domain	676 ms
	Auto Sweep Time Select	Normal
	ACP Reference	Carrier Select
	Carrier Number	12
	Carrier BW	1.28 MHz
	Carrier Spacing	1.6 MHz
	In Band Center	Center Frequency
	In Band Filter Type	Rect
	Offset-1 On/Off	On
	Offset-2 On/Off	On
	Offset-3 On/Off	Off
	Offset Freq-1	1.6 MHz
	Offset Freq-2	3.2 MHz
	Offset Freq-3	4.8 MHz
	Ch BW	1.28 MHz
Offset Filter Type	Root Nyquist	
Offset Roll-off Factor	0.22	

CDMA2000

Table C-1 Standard parameters for ACP function (Cont'd)

Standard	Parameter Name	Setting
CDMA2000 Forward Link	Trace Points	1001
	Span Frequency	4.05 MHz
	RBW	30 kHz
	Detection	RMS
	Sweep Time Freq. Domain	1.25 s
	Auto Sweep Time Select	Normal
	ACP Reference	Carrier Select
	Carrier Number	1
	Carrier BW	1.23 MHz
	Carrier Spacing	1.25 MHz
	In Band Center	Center Frequency
	In Band Filter Type	Rect
	Offset-1 On/Off	On
	Offset-2 On/Off	On
	Offset-3 On/Off	Off
	Offset Freq-1	765 kHz
	Offset Freq-2	1.995 MHz
	Offset Freq-3	4 MHz
	Ch BW	30 kHz
Offset Filter Type	Rect	

EV-DO

Table C-1 Standard parameters for ACP function (Cont'd)

Standard	Parameter Name	Setting
EV-DO Forward Link	Trace Points	1001
	Span Frequency	4.05 MHz
	RBW	30 kHz
	Detection	RMS
	Sweep Time Freq. Domain	1.667 s
	Auto Sweep Time Select	Normal
	ACP Reference	Carrier Select
	Carrier Number	1
	Carrier BW	1.23 MHz
	Carrier Spacing	1.25 MHz
	In Band Center	Center Frequency
	In Band Filter Type	Rect
	Offset-1 On/Off	On
	Offset-2 On/Off	On
	Offset-3 On/Off	Off
	Offset Freq-1	765 kHz
	Offset Freq-2	1.995 MHz
	Offset Freq-3	4 MHz
	Ch BW	30 kHz
Offset Filter Type	Rect	

TELEC-T403

Table C-1 Standard parameters for ACP function (Cont'd)

Standard	Parameter Name	Setting
TELEC-T403 18MHz SPAN (WLAN)	Frequency Span	100 MHz
	RBW	300 kHz
	Detection	POSITIVE
	SWP	Auto, Normal
	Trace Point	1001
	Adjacent Channel Power	On
	ACP Reference	Carrier-1
	Carrier Number	1
	Carrier BW	18 MHz
	Carrier Spacing	20 MHz
	In Band Center	Center Frequency
	In Band Filter Type	Rect
	Offset-1 On/Off	On
	Offset-2 On/Off	On
	Offset-3 On/Off	Off
	Offset Freq-1	20 MHz
	Offset Freq-2	40 MHz
	Ch BW	18 MHz
Offset Ch Filter Type	Rect	

Table C-1 Standard parameters for ACP function (Cont'd)

Standard	Parameter Name	Setting
TELEC-T403 19MHz SPAN (WLAN)	Frequency Span	100 MHz
	RBW	300 kHz
	Detection	POSITIVE
	SWP	Auto, Normal
	Trace Point	1001
	Adjacent Channel Power	On
	ACP Reference	Carrier-1
	Carrier Number	1
	Carrier BW	19 MHz
	Carrier Spacing	20 MHz
	In Band Center	Center Frequency
	In Band Filter Type	Rect
	Offset-1 On/Off	On
	Offset-2 On/Off	On
	Offset-3 On/Off	Off
	Offset Freq-1	20 MHz
	Offset Freq-2	40 MHz
	Ch BW	19 MHz
Offset Ch Filter Type	Rect	

Table C-1 Standard parameters for ACP function (Cont'd)

Standard	Parameter Name	Setting
TELEC-T403 38MHz SPAN (WLAN)	Frequency Span	200 MHz
	RBW	300 kHz
	Detection	POSITIVE
	SWP	Auto, Normal
	Trace Point	1001
	Adjacent Channel Power	On
	ACP Reference	Carrier-1
	Carrier Number	1
	Carrier BW	38 MHz
	Carrier Spacing	40 MHz
	In Band Center	Center Frequency
	In Band Filter Type	Rect
	Offset-1 On/Off	On
	Offset-2 On/Off	On
	Offset-3 On/Off	Off
	Offset Freq-1	40 MHz
	Offset Freq-2	80 MHz
	Ch BW	38 MHz
Offset Ch Filter Type	Rect	

Table C-1 Standard parameters for ACP function (Cont'd)

Standard	Parameter Name	Setting
TELEC-T403 78MHz SPAN (WLAN)	Frequency Span	400 MHz
	RBW	300 kHz
	Detection	POSITIVE
	SWP	Auto, Normal
	Trace Point	1001
	Adjacent Channel Power	On
	ACP Reference	Carrier-1
	Carrier Number	1
	Carrier BW	78 MHz
	Carrier Spacing	80 MHz
	In Band Center	Center Frequency
	In Band Filter Type	Rect
	Offset-1 On/Off	On
	Offset-2 On/Off	On
	Offset-3 On/Off	Off
	Offset Freq-1	80 MHz
	Offset Freq-2	160 MHz
	Ch BW	78 MHz
Offset Ch Filter Type	Rect	

TELEC-T405

Table C-1 Standard parameters for ACP function (Cont'd)

Standard	Parameter Name	Setting
TELEC-T405 20MHz BW (WLAN)	Frequency Span	100 MHz
	RBW	30 kHz
	Detection	POSITIVE
	SWP	Auto, Normal
	Trace Point	1001
	Adjacent Channel Power	On
	ACP Reference	Carrier-1
	Carrier Number	1
	Carrier BW	18 MHz
	Carrier Spacing	20 MHz
	In Band Center	Center Frequency
	In Band Filter Type	Rect
	Offset-1 On/Off	On
	Offset-2 On/Off	On
	Offset-3 On/Off	Off
	Offset Freq-1	20 MHz
	Offset Freq-2	40 MHz
	Ch BW	18 MHz
Offset Ch Filter Type	Rect	

Table C-1 Standard parameters for ACP function (Cont'd)

Standard	Parameter Name	Setting
TELEC-T405 40MHz BW (WLAN)	Frequency Span	200 MHz
	RBW	30 kHz
	Detection	POSITIVE
	SWP	Auto, Normal
	Trace Point	1001
	Adjacent Channel Power	On
	ACP Reference	Carrier-1
	Carrier Number	1
	Carrier BW	38 MHz
	Carrier Spacing	40 MHz
	In Band Center	Center Frequency
	In Band Filter Type	Rect
	Offset-1 On/Off	On
	Offset-2 On/Off	On
	Offset-3 On/Off	Off
	Offset Freq-1	40 MHz
	Offset Freq-2	80 MHz
	Ch BW	38 MHz
Offset Ch Filter Type	Rect	

BPSK

Table C-1 Standard parameters for ACP function (Cont'd)

Standard	Parameter Name	Setting
BPSK 950MHz (LR-WPANs)	Frequency Span	2 MHz
	RBW	10 kHz
	Detection	RMS
	SWP	Auto, Normal
	Trace Point	1001
	Adjacent Channel Power	On
	ACP Reference	Carrier-1
	Carrier Number	1
	Carrier BW	600 kHz
	Carrier Spacing	600 MHz
	In Band Center	Center Frequency
	In Band Filter Type	Rect
	Offset-1 On/Off	On
	Offset-2 On/Off	Off
	Offset-3 On/Off	Off
	Offset Freq-1	400 kHz
	Offset Freq-2	10 MHz
	Ch BW	200 kHz
Offset Ch Filter Type	Rect	

GFSK

Table C-1 Standard parameters for ACP function (Cont'd)

Standard	Parameter Name	Setting
GFSK 50ksps 950MHz (LR-WPANs)	Frequency Span	2 MHz
	RBW	10 kHz
	Detection	RMS
	SWP	Auto, Normal
	Trace Point	1001
	Adjacent Channel Power	On
	ACP Reference	Carrier-1
	Carrier Number	1
	Carrier BW	200 kHz
	Carrier Spacing	600 MHz
	In Band Center	Center Frequency
	In Band Filter Type	Rect
	Offset-1 On/Off	On
	Offset-2 On/Off	Off
	Offset-3 On/Off	Off
	Offset Freq-1	200 kHz
	Offset Freq-2	10 MHz
	Ch BW	200 kHz
Offset Ch Filter Type	Rect	

Table C-1 Standard parameters for ACP function (Cont'd)

Standard	Parameter Name	Setting
GFSK 100ksps 950MHz (LR-WPANs)	Frequency Span	2 MHz
	RBW	10 kHz
	Detection	RMS
	SWP	Auto, Normal
	Trace Point	1001
	Adjacent Channel Power	On
	ACP Reference	Carrier-1
	Carrier Number	1
	Carrier BW	400 kHz
	Carrier Spacing	600 MHz
	In Band Center	Center Frequency
	In Band Filter Type	Rect
	Offset-1 On/Off	On
	Offset-2 On/Off	Off
	Offset-3 On/Off	Off
	Offset Freq-1	300 kHz
	Offset Freq-2	10 MHz
	Ch BW	200 kHz
Offset Ch Filter Type	Rect	

Table C-1 Standard parameters for ACP function (Cont'd)

Standard	Parameter Name	Setting
GFSK 200ksps 950MHz (LR-WPANs)	Frequency Span	2 MHz
	RBW	10 kHz
	Detection	RMS
	SWP	Auto, Normal
	Trace Point	1001
	Adjacent Channel Power	On
	ACP Reference	Carrier-1
	Carrier Number	1
	Carrier BW	800 kHz
	Carrier Spacing	600 MHz
	In Band Center	Center Frequency
	In Band Filter Type	Rect
	Offset-1 On/Off	On
	Offset-2 On/Off	Off
	Offset-3 On/Off	Off
	Offset Freq-1	500 kHz
	Offset Freq-2	10 MHz
	Ch BW	200 kHz
Offset Ch Filter Type	Rect	

Table C-1 Standard parameters for ACP function (Cont'd)

Standard	Parameter Name	Setting
GFSK 50ksps 920MHz (LR-WPANs)	Frequency Span	2 MHz
	RBW	10 kHz
	Detection	RMS
	SWP	Auto, Normal
	Trace Point	1001
	Adjacent Channel Power	On
	ACP Reference	Carrier-1
	Carrier Number	1
	Carrier BW	200 kHz
	Carrier Spacing	600 MHz
	In Band Center	Center Frequency
	In Band Filter Type	Rect
	Offset-1 On/Off	On
	Offset-2 On/Off	Off
	Offset-3 On/Off	Off
	Offset Freq-1	200 kHz
	Offset Freq-2	10 MHz
	Ch BW	200 kHz
Offset Ch Filter Type	Rect	

Table C-1 Standard parameters for ACP function (Cont'd)

Standard	Parameter Name	Setting
GFSK 100ksps 920MHz (LR-WPANs)	Frequency Span	2 MHz
	RBW	10 kHz
	Detection	RMS
	SWP	Auto, Normal
	Trace Point	1001
	Adjacent Channel Power	On
	ACP Reference	Carrier-1
	Carrier Number	1
	Carrier BW	400 kHz
	Carrier Spacing	600 MHz
	In Band Center	Center Frequency
	In Band Filter Type	Rect
	Offset-1 On/Off	On
	Offset-2 On/Off	Off
	Offset-3 On/Off	Off
	Offset Freq-1	300 kHz
	Offset Freq-2	10 MHz
	Ch BW	200 kHz
Offset Ch Filter Type	Rect	

Table C-1 Standard parameters for ACP function (Cont'd)

Standard	Parameter Name	Setting
GFSK 200ksps 920MHz (LR-WPANs)	Frequency Span	2 MHz
	RBW	10 kHz
	Detection	RMS
	SWP	Auto, Normal
	Trace Point	1001
	Adjacent Channel Power	On
	ACP Reference	Carrier-1
	Carrier Number	1
	Carrier BW	800 kHz
	Carrier Spacing	600 MHz
	In Band Center	Center Frequency
	In Band Filter Type	Rect
	Offset-1 On/Off	On
	Offset-2 On/Off	Off
	Offset-3 On/Off	Off
	Offset Freq-1	500 kHz
	Offset Freq-2	10 MHz
	Ch BW	200 kHz
Offset Ch Filter Type	Rect	

Table C-1 Standard parameters for ACP function (Cont'd)

Standard	Parameter Name	Setting
GFSK 50ksps 802.15.4gd7 (LR-WPANs)	Frequency Span	2 MHz
	RBW	10 kHz
	Detection	RMS
	SWP	Auto, Normal
	Trace Point	1001
	Adjacent Channel Power	On
	ACP Reference	Carrier-1
	Carrier Number	1
	Carrier BW	75 kHz
	Carrier Spacing	150 MHz
	In Band Center	Center Frequency
	In Band Filter Type	Rect
	Offset-1 On/Off	On
	Offset-2 On/Off	On
	Offset-3 On/Off	Off
	Offset Freq-1	150 kHz
	Offset Freq-2	300 kHz
	Ch BW	150 kHz
Offset Ch Filter Type	Rect	

Table C-1 Standard parameters for ACP function (Cont'd)

Standard	Parameter Name	Setting
GFSK 100ksps 802.15.4gd7 (LR-WPANs)	Frequency Span	2 MHz
	RBW	10 kHz
	Detection	RMS
	SWP	Auto, Normal
	Trace Point	1001
	Adjacent Channel Power	On
	ACP Reference	Carrier-1
	Carrier Number	1
	Carrier BW	150 kHz
	Carrier Spacing	300 MHz
	In Band Center	Center Frequency
	In Band Filter Type	Rect
	Offset-1 On/Off	On
	Offset-2 On/Off	On
	Offset-3 On/Off	Off
	Offset Freq-1	300 kHz
	Offset Freq-2	600 kHz
	Ch BW	300 kHz
Offset Ch Filter Type	Rect	

Table C-1 Standard parameters for ACP function (Cont'd)

Standard	Parameter Name	Setting
GFSK 200ksps 802.15.4gd7 (LR-WPANs)	Frequency Span	3 MHz
	RBW	10 kHz
	Detection	RMS
	SWP	Auto, Normal
	Trace Point	1001
	Adjacent Channel Power	On
	ACP Reference	Carrier-1
	Carrier Number	1
	Carrier BW	300 kHz
	Carrier Spacing	600 MHz
	In Band Center	Center Frequency
	In Band Filter Type	Rect
	Offset-1 On/Off	On
	Offset-2 On/Off	On
	Offset-3 On/Off	Off
	Offset Freq-1	600 kHz
	Offset Freq-2	1.2 MHz
	Ch BW	600 kHz
Offset Ch Filter Type	Rect	

APCO

Table C-1 Standard parameters for ACP function (Cont'd)

Standard	Parameter Name	Setting
APCO P25 Except 700MHz-band	Frequency Span	100 kHz
	RBW	100 Hz
	Detection	RMS
	Storage Mode	Average
	Sweep Time Switch	Auto
	Auto Sweep Time Select	Normal
	Adjacent Channel Power	On
	ACP Reference	Carrier Select
	Carrier Number	1
	Carrier BW	12.5 kHz
	Carrier Spacing	12.5 kHz
	In Band Center	Center Frequency
	In Band Filter Type	Rect
	Offset – 1 On/Off	On
	Offset – 2 On/Off	Off
	Offset – 3 On/Off	Off
	Offset Freq – 1	12.5 kHz
	Offset Freq – 2	25 kHz
	Offset Freq – 3	15 MHz
	Ch BW	6 kHz
Offset Ch Filter Type	Rect	

Table C-1 Standard parameters for ACP function (Cont'd)

Standard	Parameter Name	Setting
APCO P25 700MHz-BW-6.2 5kHz	Frequency Span	100 kHz
	RBW	100 Hz
	Detection	RMS
	Storage Mode	Average
	Sweep Time Switch	Auto
	Auto Sweep Time Select	Normal
	Adjacent Channel Power	On
	ACP Reference	Both Sides of Carriers
	Carrier Number	1
	Carrier BW	12.5 kHz
	Carrier Spacing	12.5 kHz
	In Band Center	Center Frequency
	In Band Filter Type	Rect
	Offset – 1 On/Off	On
	Offset – 2 On/Off	On
	Offset – 3 On/Off	On
	Offset Freq – 1	9.375 kHz
	Offset Freq – 2	15.625 kHz
	Offset Freq – 3	21.875 MHz
	Ch BW	6.25 kHz
Offset Ch Filter Type	Rect	

Table C-1 Standard parameters for ACP function (Cont'd)

Standard	Parameter Name	Setting
APCO P25 700MHz-BW-25k Hz	Frequency Span	250 kHz
	RBW	100 Hz
	Detection	RMS
	Storage Mode	Average
	Sweep Time Switch	Auto
	Auto Sweep Time Select	Normal
	Adjacent Channel Power	On
	ACP Reference	Both Sides of Carriers
	Carrier Number	1
	Carrier BW	12.5 kHz
	Carrier Spacing	12.5 kHz
	In Band Center	Center Frequency
	In Band Filter Type	Rect
	Offset – 1 On/Off	On
	Offset – 2 On/Off	On
	Offset – 3 On/Off	On
	Offset Freq – 1	37.5 kHz
	Offset Freq – 2	62.5 kHz
	Offset Freq – 3	87.5 MHz
	Ch BW	25 kHz
Offset Ch Filter Type	Rect	

Table C-1 Standard parameters for ACP function (Cont'd)

Standard	Parameter Name	Setting
APCO P25 700MHz-BW-100 kHz	Frequency Span	1 MHz
	RBW	100 Hz
	Detection	RMS
	Storage Mode	Average
	Sweep Time Switch	Auto
	Auto Sweep Time Select	Normal
	Adjacent Channel Power	On
	ACP Reference	Both Sides of Carriers
	Carrier Number	1
	Carrier BW	12.5 kHz
	Carrier Spacing	12.5 kHz
	In Band Center	Center Frequency
	In Band Filter Type	Rect
	Offset – 1 On/Off	On
	Offset – 2 On/Off	On
	Offset – 3 On/Off	On
	Offset Freq – 1	150 kHz
	Offset Freq – 2	250 kHz
	Offset Freq – 3	350 MHz
	Ch BW	100 kHz
Offset Ch Filter Type	Rect	

NXDN

Table C-1 Standard parameters for ACP function (Cont'd)

Standard	Parameter Name	Setting
NXDN BW-6.25kHz	Frequency Span	30 kHz
	RBW	100 Hz
	Detection	RMS
	Storage Mode	Average
	Sweep Time Switch	Auto
	Auto Sweep Time Select	Normal
	Adjacent Channel Power	On
	ACP Reference	Both Sides of Carriers
	Carrier Number	1
	Carrier BW	4 kHz
	Carrier Spacing	6.25 kHz
	In Band Center	Center Frequency
	In Band Filter Type	Rect
	Offset – 1 On/Off	On
	Offset – 2 On/Off	Off
	Offset – 3 On/Off	Off
	Offset Freq – 1	6.25 kHz
	Offset Freq – 2	12.5 kHz
	Offset Freq – 3	18.75 MHz
	Ch BW	4 kHz
Offset Ch Filter Type	Rect	

Table C-1 Standard parameters for ACP function (Cont'd)

Standard	Parameter Name	Setting
NXDN BW-12.5kHz	Frequency Span	70 kHz
	RBW	100 Hz
	Detection	RMS
	Storage Mode	Average
	Sweep Time Switch	Auto
	Auto Sweep Time Select	Normal
	Adjacent Channel Power	On
	ACP Reference	Carrier-1
	Carrier Number	1
	Carrier BW	8.3 kHz
	Carrier Spacing	12.5 kHz
	In Band Center	Center Frequency
	In Band Filter Type	Rect
	Offset – 1 On/Off	On
	Offset – 2 On/Off	Off
	Offset – 3 On/Off	Off
	Offset Freq – 1	12.5 kHz
	Offset Freq – 2	25 kHz
	Offset Freq – 3	37.5 MHz
	Ch BW	8.3 kHz
Offset Ch Filter Type	Rect	

C-2 Burst Average Power

W-CDMA/Mobile WiMAX/LTE/DSRC

Table C-2 Standard parameters for Burst Average Power

Standard	Parameter Name	Setting
W-CDMA Uplink/Downlink	RBW	20 MHz
	Detection	RMS
	SWP	10 ms
	Trace Point	1001
	Burst Average Power	On
Mobile WiMAX DL / UL 5ms Frame	RBW	20 MHz
	Detection	RMS
	SWP	5 ms
	Trace Point	1001
	Burst Average Power	On
LTE Uplink/Downlink Mean Power 1.4MHz BW	RBW	20 MHz
	Detection	RMS
	SWP	10 ms
	Trace Point	1001
	Burst Average Power	On
LTE Uplink/Downlink Mean Power 3MHz BW	RBW	20 MHz
	Detection	RMS
	SWP	10 ms
	Trace Point	1001
	Burst Average Power	On
LTE Uplink/Downlink Mean Power 5MHz BW	RBW	20 MHz
	Detection	RMS
	SWP	10 ms
	Trace Point	1001
	Burst Average Power	On
LTE Uplink/Downlink Mean Power 10MHz BW	RBW	20 MHz
	Detection	RMS
	SWP	10 ms
	Trace Point	1001
	Burst Average Power	On
DSRC $\pi/4$ DQPSK	RBW	20 MHz
	Detection	RMS
	SWP	782 μ s
	Trace Point	10001
	Burst Average Power	On

TD-SCDMA/LTE TDD/CDMA2000/EV-DO

Table C-2 Standard parameters for Burst Average Power(Cont'd)

Standard	Parameter Name	Setting
TD-SCDMA 5ms Subframe	RBW	20 MHz
	Detection	RMS
	SWP	5 ms
	Trace Point	1001
	Burst Average Power	On
LTE TDD Uplink/Downlink Mean Power 1.4MHz BW	RBW	20 MHz
	Detection	RMS
	SWP	10 ms
	Trace Point	1001
	Burst Average Power	On
LTE TDD Uplink/Downlink Mean Power 3MHz BW	RBW	20 MHz
	Detection	RMS
	SWP	10 ms
	Trace Point	1001
	Burst Average Power	On
LTE TDD Uplink/Downlink Mean Power 5MHz BW	RBW	20 MHz
	Detection	RMS
	SWP	10 ms
	Trace Point	1001
	Burst Average Power	On
LTE TDD Uplink/Downlink Mean Power 10MHz BW	RBW	20 MHz
	Detection	RMS
	SWP	10 ms
	Trace Point	1001
	Burst Average Power	On
CDMA2000 Forward Link	RBW	5 MHz
	Detection	RMS
	SWP	1.25 ms
	Trace Point	1001
	Burst Average Power	On
EV-DO Forward Link	RBW	5 MHz
	Detection	RMS
	SWP	1.667 ms
	Trace Point	1001
	Burst Average Power	On

C-3 Channel Power

W-CDMA

Table C-3 Standard parameters for Channel Power function

Standard	Parameter Name	Setting
W-CDMA Uplink/Downlink (Mean Power)	Frequency Span	10 MHz
	RBW	Auto
	Detection	RMS
	SWP	Auto, Normal
	Trace Point	1001
	Channel Power	On
	Channel Center	Center Frequency
	Channel Width	5 MHz
	Filter Type	Rect
W-CDMA Uplink/Downlink (RRC Filtered Power)	Frequency Span	10 MHz
	RBW	Auto
	Detection	RMS
	SWP	Auto, Normal
	Trace Point	1001
	Channel Power	On
	Channel Center	Center Frequency
	Channel Width	3.84 MHz
	Filter Type	Root Nyquist
	Filter Roll-off Factor	0.22

Mobile WiMAX

Table C-3 Standard parameters for Channel Power function (Cont'd)

Standard	Parameter Name	Setting
Mobile WiMAX DL / UL 10MHz BW	Frequency Span	20 MHz
	RBW	Auto
	Detection	RMS
	SWP	Auto, Normal
	Trace Point	1001
	Channel Power	On
	Channel Center	Center Frequency
	Channel Width	10 MHz
	Filter Type	Rect
Mobile WiMAX DL / UL 5MHz BW	Frequency Span	15 MHz
	RBW	Auto
	Detection	RMS
	SWP	Auto, Normal
	Trace Point	1001
	Channel Power	On
	Channel Center	Center Frequency
	Channel Width	5 MHz
	Filter Type	Rect

LTE

Table C-3 Standard parameters for Channel Power function (Cont'd)

Standard	Parameter Name	Setting
LTE Uplink/Downlink Mean Power 1.4MHz BW	Frequency Span	2.8 MHz
	RBW	Auto
	Detection	RMS
	SWP	Auto, Normal
	Trace Point	1001
	Channel Power	On
	Channel Center	Center Frequency
	Channel Width	1.4 MHz
	Filter Type	Rect
LTE Uplink/Downlink Mean Power 3MHz BW	Frequency Span	6 MHz
	RBW	Auto
	Detection	RMS
	SWP	Auto, Normal
	Trace Point	1001
	Channel Power	On
	Channel Center	Center Frequency
	Channel Width	3 MHz
	Filter Type	Rect
LTE Uplink/Downlink Mean Power 5MHz BW	Frequency Span	10 MHz
	RBW	Auto
	Detection	RMS
	SWP	Auto, Normal
	Trace Point	1001
	Channel Power	On
	Channel Center	Center Frequency
	Channel Width	5 MHz
	Filter Type	Rect

Table C-3 Standard parameters for Channel Power function (Cont'd)

Standard	Parameter Name	Setting
LTE Uplink/Downlink Mean Power 10MHz BW	Frequency Span	20 MHz
	RBW	Auto
	Detection	RMS
	SWP	Auto, Normal
	Trace Point	1001
	Channel Power	On
	Channel Center	Center Frequency
	Channel Width	10 MHz
	Filter Type	Rect
LTE Uplink/Downlink Mean Power 15MHz BW	Frequency Span	30 MHz
	RBW	Auto
	Detection	RMS
	SWP	Auto, Normal
	Trace Point	1001
	Channel Power	On
	Channel Center	Center Frequency
	Channel Width	15 MHz
	Filter Type	Rect
LTE Uplink/Downlink Mean Power 20MHz BW	Frequency Span	40 MHz
	RBW	Auto
	Detection	RMS
	SWP	Auto, Normal
	Trace Point	1001
	Channel Power	On
	Channel Center	Center Frequency
	Channel Width	20 MHz
	Filter Type	Rect

Table C-3 Standard parameters for Channel Power function (Cont'd)

Standard	Parameter Name	Setting
LTE Uplink/Downlink Filtered Power 1.4MHz BW	Frequency Span	2.8 MHz
	RBW	Auto
	Detection	RMS
	SWP	Auto, Normal
	Trace Point	1001
	Channel Power	On
	Channel Center	Center Frequency
	Channel Width	1.095 MHz (DL) 1.08 MHz (UL)
	Filter Type	Rect
LTE Uplink/Downlink Filtered Power 3MHz BW	Frequency Span	6 MHz
	RBW	Auto
	Detection	RMS
	SWP	Auto, Normal
	Trace Point	1001
	Channel Power	On
	Channel Center	Center Frequency
	Channel Width	2.715 MHz (DL) 2.7 MHz (UL)
	Filter Type	Rect
LTE Uplink/Downlink Filtered Power 5MHz BW	Frequency Span	10 MHz
	RBW	Auto
	Detection	RMS
	SWP	Auto, Normal
	Trace Point	1001
	Channel Power	On
	Channel Center	Center Frequency
	Channel Width	4.515 MHz (DL) 4.5 MHz (UL)
	Filter Type	Rect

Table C-3 Standard parameters for Channel Power function (Cont'd)

Standard	Parameter Name	Setting
LTE Uplink/Downlink Filtered Power 10MHz BW	Frequency Span	20 MHz
	RBW	Auto
	Detection	RMS
	SWP	Auto, Normal
	Trace Point	1001
	Channel Power	On
	Channel Center	Center Frequency
	Channel Width	9.015 MHz (DL) 9 MHz (UL)
	Filter Type	Rect
LTE Uplink/Downlink Filtered Power 15MHz BW	Frequency Span	30 MHz
	RBW	Auto
	Detection	RMS
	SWP	Auto, Normal
	Trace Point	1001
	Channel Power	On
	Channel Center	Center Frequency
	Channel Width	13.515 MHz (DL) 13.5 MHz (UL)
	Filter Type	Rect
LTE Uplink/Downlink Filtered Power 20MHz BW	Frequency Span	40 MHz
	RBW	Auto
	Detection	RMS
	SWP	Auto, Normal
	Trace Point	1001
	Channel Power	On
	Channel Center	Center Frequency
	Channel Width	18.015 MHz (DL) 18 MHz (UL)
	Filter Type	Rect

LTE TDD

Table C-3 Standard parameters for Channel Power function (Cont'd)

Standard	Parameter Name	Setting
LTE TDD Uplink/Downlink Mean Power 1.4MHz BW	Frequency Span	2.8 MHz
	RBW	Auto
	Detection	RMS
	SWP	Auto, Normal
	Trace Point	1001
	Channel Power	On
	Channel Center	Center Frequency
	Channel Width	1.4 MHz
LTE TDD Uplink/Downlink Mean Power 3MHz BW	Filter Type	Rect
	Frequency Span	6 MHz
	RBW	Auto
	Detection	RMS
	SWP	Auto, Normal
	Trace Point	1001
	Channel Power	On
	Channel Center	Center Frequency
LTE TDD Uplink/Downlink Mean Power 5MHz BW	Channel Width	3 MHz
	Filter Type	Rect
	Frequency Span	10 MHz
	RBW	Auto
	Detection	RMS
	SWP	Auto, Normal
	Trace Point	1001
	Channel Power	On
Channel Center	Center Frequency	
Channel Width	5 MHz	
Filter Type	Rect	

Table C-3 Standard parameters for Channel Power function (Cont'd)

Standard	Parameter Name	Setting
LTE TDD Uplink/Downlink Mean Power 10MHz BW	Frequency Span	20 MHz
	RBW	Auto
	Detection	RMS
	SWP	Auto, Normal
	Trace Point	1001
	Channel Power	On
	Channel Center	Center Frequency
	Channel Width	10 MHz
	Filter Type	Rect
LTE TDD Uplink/Downlink Mean Power 15MHz BW	Frequency Span	30 MHz
	RBW	Auto
	Detection	RMS
	SWP	Auto, Normal
	Trace Point	1001
	Channel Power	On
	Channel Center	Center Frequency
	Channel Width	15 MHz
	Filter Type	Rect
LTE TDD Uplink/Downlink Mean Power 20MHz BW	Frequency Span	40 MHz
	RBW	Auto
	Detection	RMS
	SWP	Auto, Normal
	Trace Point	1001
	Channel Power	On
	Channel Center	Center Frequency
	Channel Width	20 MHz
	Filter Type	Rect

Table C-3 Standard parameters for Channel Power function (Cont'd)

Standard	Parameter Name	Setting
LTE TDD Uplink/Downlink Filtered Power 1.4MHz BW	Frequency Span	2.8 MHz
	RBW	Auto
	Detection	RMS
	SWP	Auto, Normal
	Trace Point	1001
	Channel Power	On
	Channel Center	Center Frequency
	Channel Width	1.095 MHz (DL) 1.08 MHz (UL)
	Filter Type	Rect
LTE TDD Uplink/Downlink Filtered Power 3MHz BW	Frequency Span	6 MHz
	RBW	Auto
	Detection	RMS
	SWP	Auto, Normal
	Trace Point	1001
	Channel Power	On
	Channel Center	Center Frequency
	Channel Width	2.715 MHz (DL) 2.7 MHz (UL)
	Filter Type	Rect
LTE TDD Uplink/Downlink Filtered Power 5MHz BW	Frequency Span	10 MHz
	RBW	Auto
	Detection	RMS
	SWP	Auto, Normal
	Trace Point	1001
	Channel Power	On
	Channel Center	Center Frequency
	Channel Width	4.515 MHz (DL) 4.5 MHz (UL)
	Filter Type	Rect

Table C-3 Standard parameters for Channel Power function (Cont'd)

Standard	Parameter Name	Setting
LTE TDD Uplink/Downlink Filtered Power 10MHz BW	Frequency Span	20 MHz
	RBW	Auto
	Detection	RMS
	SWP	Auto, Normal
	Trace Point	1001
	Channel Power	On
	Channel Center	Center Frequency
	Channel Width	9.015 MHz (DL) 9 MHz (UL)
	Filter Type	Rect
LTE TDD Uplink/Downlink Filtered Power 15MHz BW	Frequency Span	30 MHz
	RBW	Auto
	Detection	RMS
	SWP	Auto, Normal
	Trace Point	1001
	Channel Power	On
	Channel Center	Center Frequency
	Channel Width	13.515 MHz (DL) 13.5 MHz (UL)
	Filter Type	Rect
LTE TDD Uplink/Downlink Filtered Power 20MHz BW	Frequency Span	40 MHz
	RBW	Auto
	Detection	RMS
	SWP	Auto, Normal
	Trace Point	1001
	Channel Power	On
	Channel Center	Center Frequency
	Channel Width	18.015 MHz (DL) 18 MHz (UL)
	Filter Type	Rect

DSRC

Table C-3 Standard parameters for Channel Power function (Cont'd)

Standard	Parameter Name	Setting
DSRC $\pi/4$ DQPSK	Frequency Span	10 MHz
	RBW	Auto
	Detection	RMS
	Sweep Time Switch	Manual
	Sweep Time Freq. Domain	7.1 s
	Auto Sweep Time Select	Normal
	Trace Point	1001
	Channel Power	On
	Channel Center	Center Frequency
	Channel Width	4.4 MHz
	Filter Type	Rect
DSRC ASK	Frequency Span	10 MHz
	RBW	Auto
	Detection	Positive
	Sweep Time Switch	Manual
	Sweep Time Freq. Domain	7.1 s
	Auto Sweep Time Select	Normal
	Trace Point	1001
	Channel Power	On
	Channel Center	Center Frequency
	Channel Width	4.4 MHz
	Filter Type	Rect

TD-SCDMA/XG-PHS/CDMA2000/EV-DO

Table C-3 Standard parameters for Channel Power function (Cont'd)

Standard	Parameter Name	Setting
TD-SCDMA	Frequency Span	2 MHz
	RBW	Auto
	Detection	RMS
	Gate Length	662.5 μ s
	Sweep Time Switch	Manual
	Sweep Time Freq. Domain	676 ms
	Auto Sweep Time Select	Normal
	Trace Point	1001
	Channel Power	On
	Channel Center	Center Frequency
	Channel Width	1.6 MHz
	Filter Type	Rect
XG-PHS Mean Power 10MHz BW	Frequency Span	20 MHz
	RBW	Auto
	Detection	RMS
	Gate Sweep	Off
	Sweep Time Switch	Manual
	Sweep Time Freq. Domain	5000 ms
	Trace Point	1001
	Channel Power	On
	Channel Center	Center Frequency
	Channel Width	10 MHz
	Filter Type	Rect

Table C-3 Standard parameters for Channel Power function (Cont'd)

Standard	Parameter Name	Setting
XG-PHS Mean Power 20MHz BW	Frequency Span	40 MHz
	RBW	Auto
	Detection	RMS
	Gate Sweep	Off
	Sweep Time Switch	Manual
	Sweep Time Freq. Domain	5000 ms
	Trace Point	1001
	Channel Power	On
	Channel Center	Center Frequency
	Channel Width	20 MHz
	Filter Type	Rect
CDMA2000 Forward Link	Frequency Span	2.5 MHz
	RBW	Auto
	Detection	RMS
	Sweep Time Switch	Manual
	Sweep Time Freq. Domain	1.25 s
	Auto Sweep Time Select	Normal
	Trace Point	1001
	Channel Power	On
	Channel Center	Center Frequency
	Channel Width	1.23 MHz
	Filter Type	Rect
EV-DO Forward Link	Frequency Span	2.5 MHz
	RBW	Auto
	Detection	RMS
	Sweep Time Switch	Manual
	Sweep Time Freq. Domain	1.667 s
	Auto Sweep Time Select	Normal
	Trace Point	1001
	Channel Power	On
	Channel Center	Center Frequency
	Channel Width	1.23 MHz
	Filter Type	Rect

ISDB-Tmm/ISDB-T

Table C-3 Standard parameters for Channel Power function (Cont'd)

Standard	Parameter Name	Setting
ISDB-Tmm 14.2MHz BW (Mean Power)	Frequency Span	20 MHz
	RBW	Auto
	Detection	RMS
	SWP	Auto, Normal
	Trace Point	1001
	Channel Power	On
	Channel Center	Center Frequency
	Channel Width	14.2 MHz
	Filter Type	Rect
ISDB-Tmm (ISDB-T) 5.6MHz BW (Mean Power)	Frequency Span	10 MHz
	RBW	Auto
	Detection	RMS
	SWP	Auto, Normal
	Trace Point	1001
	Channel Power	On
	Channel Center	Center Frequency
	Channel Width	5.6 MHz
	Filter Type	Rect
ISDB-T 5.6MHz BW (Mean Power)	Frequency Span	10 MHz
	RBW	Auto
	Detection	RMS
	SWP	Auto, Normal
	Trace Point	1001
	Channel Power	On
	Channel Center	Center Frequency
	Channel Width	5.6 MHz
	Filter Type	Rect

ISDB-T_{SB}

Table C-3 Standard parameters for Channel Power function (Cont'd)

Standard	Parameter Name	Setting
ISDB-T _{SB} 3.9MHz BW (Mean Power)	Frequency Span	20 MHz
	RBW	Auto
	Detection	RMS
	SWP	Auto, Normal
	Trace Point	1001
	Channel Power	On
	Channel Center	Center Frequency
	Channel Width	3.9 MHz
	Filter Type	Rect

C-4 OBW

W-CDMA/Mobile WiMAX

Table C-4 Standard parameters for OBW function

Standard	Parameter Name	Setting
W-CDMA Uplink/Downlink	Method	N% of Power
	N% Ratio	99.00%
	Frequency Span	10 MHz
	RBW	30 kHz
	Detection	RMS
	SWP	Auto, Normal
	OBW	On
	Trace Point	1001
Mobile WiMAX DL / UL 10MHz BW	Method	N% of Power
	N% Ratio	99.00%
	Frequency Span	30 MHz
	RBW	100 kHz
	Detection	Positive
	SWP	Auto, Fast
	OBW	On
	Trace Point	1001
Mobile WiMAX DL / UL 5MHz BW	Method	N% of Power
	N% Ratio	99.00%
	Frequency Span	15 MHz
	RBW	100 kHz
	Detection	Positive
	SWP	Auto, Fast
	OBW	On
	Trace Point	1001

LTE

Table C-4 Standard parameters for OBW function (Cont'd)

Standard	Parameter Name	Setting
LTE Uplink/Downlink 1.4MHz Bandwidth	Method	N% of Power
	N% Ratio	99.00%
	Frequency Span	2.8 MHz
	RBW	10 kHz
	Detection	RMS
	SWP	Auto, Normal
	OBW	On
LTE Uplink/Downlink 3MHz Bandwidth	Method	N% of Power
	N% Ratio	99.00%
	Frequency Span	6 MHz
	RBW	30 kHz
	Detection	RMS
	SWP	Auto, Normal
	OBW	On
LTE Uplink/Downlink 5MHz Bandwidth	Method	N% of Power
	N% Ratio	99.00%
	Frequency Span	10 MHz
	RBW	30 kHz
	Detection	RMS
	SWP	Auto, Normal
	OBW	On
	Trace Point	1001

Table C-4 Standard parameters for OBW function (Cont'd)

Standard	Parameter Name	Setting
LTE Uplink/Downlink 10MHz Bandwidth	Method	N% of Power
	N% Ratio	99.00%
	Frequency Span	20 MHz
	RBW	100 kHz
	Detection	RMS
	SWP	Auto, Normal
	OBW	On
	Trace Point	1001
LTE Uplink/Downlink 15MHz Bandwidth	Method	N% of Power
	N% Ratio	99.00%
	Frequency Span	30 MHz
	RBW	100 kHz
	Detection	RMS
	SWP	Auto, Normal
	OBW	On
	Trace Point	1001
LTE Uplink/Downlink 20MHz Bandwidth	Method	N% of Power
	N% Ratio	99.00%
	Frequency Span	40 MHz
	RBW	100 kHz
	Detection	RMS
	SWP	Auto, Normal
	OBW	On
	Trace Point	1001

LTE TDD

Table C-4 Standard parameters for OBW function (Cont'd)

Standard	Parameter Name	Setting
LTE TDD Uplink/Downlink 1.4MHz Bandwidth	Method	N% of Power
	N% Ratio	99.00%
	Frequency Span	2.8 MHz
	RBW	10 kHz
	Detection	RMS
	SWP	Auto, Normal
	OBW	On
LTE TDD Uplink/Downlink 3MHz Bandwidth	Trace Point	401 (DL) 1001 (UL)
	Method	N% of Power
	N% Ratio	99.00%
	Frequency Span	6 MHz
	RBW	30 kHz
	Detection	RMS
	SWP	Auto, Normal
LTE TDD Uplink/Downlink 5MHz Bandwidth	OBW	On
	Trace Point	401 (DL) 1001 (UL)
	Method	N% of Power
	N% Ratio	99.00%
	Frequency Span	10 MHz
	RBW	30 kHz
	Detection	RMS
SWP	Auto, Normal	
	OBW	On
	Trace Point	1001

Table C-4 Standard parameters for OBW function (Cont'd)

Standard	Parameter Name	Setting
LTE TDD Uplink/Downlink 10MHz Bandwidth	Method	N% of Power
	N% Ratio	99.00%
	Frequency Span	20 MHz
	RBW	100 kHz
	Detection	RMS
	SWP	Auto, Normal
	OBW	On
	Trace Point	1001
LTE TDD Uplink/Downlink 15MHz Bandwidth	Method	N% of Power
	N% Ratio	99.00%
	Frequency Span	30 MHz
	RBW	100 kHz
	Detection	RMS
	SWP	Auto, Normal
	OBW	On
	Trace Point	1001
LTE TDD Uplink/Downlink 20MHz Bandwidth	Method	N% of Power
	N% Ratio	99.00%
	Frequency Span	40 MHz
	RBW	100 kHz
	Detection	RMS
	SWP	Auto, Normal
	OBW	On
	Trace Point	1001

DSRC

Table C-4 Standard parameters for OBW function (Cont'd)

Standard	Parameter Name	Setting
DSRC $\pi/4$ DQPSK	Method	N% of Power
	N% Ratio	99.00%
	Frequency Span	10 MHz
	RBW	30 kHz
	VBW	30 kHz
	VBW Mode	Power
	Detection	Positive
	Sweep Time Switch	Manual
	Sweep Time Freq. Domain	7.1 s
	Auto Sweep Time Select	Normal
	OBW	On
	Trace Point	1001
DSRC ASK	Method	N% of Power
	N% Ratio	99.00%
	Frequency Span	10 MHz
	RBW	30 kHz
	VBW	30 kHz
	VBW Mode	Power
	Detection	Positive
	Sweep Time Switch	Manual
	Sweep Time Freq. Domain	7.1 s
	Auto Sweep Time Select	Normal
	OBW	On
	Trace Point	1001

TD-SCDMA/XG-PHS/CDMA2000/EV-DO

Table C-4 Standard parameters for OBW function (Cont'd)

Standard	Parameter Name	Setting
TD-SCDMA	Method	N% of Power
	N% Ratio	99.00%
	Frequency Span	5 MHz
	RBW	30 kHz
	Detection	RMS
	Sweep Time Switch	Manual
	Sweep Time Freq. Domain	676 ms
	Auto Sweep Time Select	Normal
	OBW	On
	Trace Point	1001
XG-PHS 10MHz Bandwidth	Method	N% of Power
	N% Ratio	99.00%
	Frequency Span	20 MHz
	RBW	100 kHz
	VBW	300 kHz
	Storage Mode	Max Hold
	Storage Count	10
	Detection	Positive
	Sweep Time Switch	Manual
	Sweep Time Freq. Domain	5000 ms
	Auto Sweep Time Select	Normal
	OBW	On
	Trace Point	1001

Table C-4 Standard parameters for OBW function (Cont'd)

Standard	Parameter Name	Setting
XG-PHS 20MHz Bandwidth	Method	N% of Power
	N% Ratio	99.00%
	Frequency Span	40 MHz
	RBW	100 kHz
	VBW	300 kHz
	Storage Mode	Max Hold
	Storage Count	10
	Detection	Positive
	Sweep Time Switch	Manual
	Sweep Time Freq. Domain	5000 ms
	Auto Sweep Time Select	Normal
	OBW	On
Trace Point	1001	
CDMA2000 Forward Link	Method	N% of Power
	N% Ratio	99.00%
	Frequency Span	4 MHz
	RBW	30 kHz
	Detection	Positive
	Sweep Time Switch	Manual
	Sweep Time Freq. Domain	1.25 s
	Auto Sweep Time Select	Normal
	OBW	On
	Trace Point	1001
EV-DO Forward Link	Method	N% of Power
	N% Ratio	99.00%
	Frequency Span	4 MHz
	RBW	30 kHz
	Detection	Positive
	Sweep Time Switch	Manual
	Sweep Time Freq. Domain	1.667 s
	Auto Sweep Time Select	Normal
	OBW	On
Trace Point	1001	

ISDB-Tmm/ISDB-T/ISDB-T_{SB}

Table C-4 Standard parameters for OBW function (Cont'd)

Standard	Parameter Name	Setting
ISDB-Tmm 14.2MHz BW	Method	N% of Power
	N% Ratio	99.00%
	Frequency Span	20 MHz
	RBW	10 kHz
	Detection	RMS
	SWP	Auto, Normal
	OBW	On
	Trace Point	1001
ISDB-Tmm (ISDB-T) 5.6MHz BW	Method	N% of Power
	N% Ratio	99.00%
	Frequency Span	20 MHz
	RBW	10 kHz
	VBW	300 Hz
	Detection	Positive
	SWP	Auto, Normal
	OBW	On
	Trace Point	1001
ISDB-T 5.6MHz BW	Method	N% of Power
	N% Ratio	99.00%
	Frequency Span	20 MHz
	RBW	10 kHz
	VBW	300 Hz
	Detection	Positive
	SWP	Auto, Normal
	OBW	On
	Trace Point	1001
ISDB-T _{SB} 3.9MHz BW	Method	N% of Power
	N% Ratio	99.00%
	Frequency Span	20 MHz
	RBW	10 kHz
	Detection	Positive
	SWP	Auto, Normal
	OBW	On
	Trace Point	1001

TELEC-T401/TELEC-T403

Table C-4 Standard parameters for OBW function (Cont'd)

Standard	Parameter Name	Setting
TELEC-T401 DSSS/CCK (WLAN)	Method	N% of Power
	N% Ratio	99.00%
	Frequency Span	60 MHz
	RBW	300 kHz
	VBW	300 kHz
	Detection	Positive
	SWP	Auto, Normal
	OBW	On
	Trace Point	1001
TELEC-T401 OFDM (WLAN)	Method	N% of Power
	N% Ratio	99.00%
	Frequency Span	80 MHz
	RBW	300 kHz
	VBW	300 kHz
	Detection	Positive
	SWP	Auto, Normal
	OBW	On
	Trace Point	1001
TELEC-T403 20MHz (WLAN)	Method	N% of Power
	N% Ratio	99.00%
	Frequency Span	60 MHz
	RBW	300 kHz
	VBW	300 kHz
	Detection	Positive
	SWP	Auto, Normal
	OBW	On
	Trace Point	1001

Table C-4 Standard parameters for OBW function (Cont'd)

Standard	Parameter Name	Setting
TELEC-T403 40MHz (WLAN)	Method	N% of Power
	N% Ratio	99.00%
	Frequency Span	80 MHz
	RBW	300 kHz
	VBW	300 kHz
	Detection	Positive
	SWP	Auto, Normal
	OBW	On
	Trace Point	1001
TELEC-T403 80MHz (WLAN)	Method	N% of Power
	N% Ratio	99.00%
	Frequency Span	160 MHz
	RBW	300 kHz
	VBW	300 kHz
	Detection	Positive
	SWP	Auto, Normal
	OBW	On
	Trace Point	1001
TELEC-T403 160MHz (WLAN)	Method	N% of Power
	N% Ratio	99.00%
	Frequency Span	320 MHz
	RBW	300 kHz
	VBW	300 kHz
	Detection	Positive
	SWP	Auto, Normal
	OBW	On
	Trace Point	1001

TELEC-T405

Table C-4 Standard parameters for OBW function (Cont'd)

Standard	Parameter Name	Setting
TELEC-T405 20MHz (WLAN)	Method	N% of Power
	N% Ratio	99.00%
	Frequency Span	60 MHz
	RBW	30 kHz
	VBW	30 kHz
	Detection	Positive
	SWP	Auto, Normal
	OBW	On
	Trace Point	1001
TELEC-T405 40MHz (WLAN)	Method	N% of Power
	N% Ratio	99.00%
	Frequency Span	80 MHz
	RBW	30 kHz
	VBW	30 kHz
	Detection	Positive
	SWP	Auto, Normal
	OBW	On
	Trace Point	1001

ETSI EN 301 893

Table C-4 Standard parameters for OBW function (Cont'd)

Standard	Parameter Name	Setting
ETSI EN 301 893 V1.5.1 OFDM 5MHZ (WLAN)	Method	xdB Down
	XdB Value	6dB
	Frequency Span	10 MHz
	RBW	100 kHz
	VBW	100 kHz
	Detection	Positive
	SWP	Auto, Normal
	OBW	On
	Trace Point	1001
ETSI EN 301 893 V1.5.1 OFDM 10MHZ (WLAN)	Method	xdB Down
	XdB Value	6dB
	Frequency Span	20 MHz
	RBW	100 kHz
	VBW	100 kHz
	Detection	Positive
	SWP	Auto, Normal
	OBW	On
	Trace Point	1001
ETSI EN 301 893 V1.5.1 OFDM 20MHZ (WLAN)	Method	xdB Down
	XdB Value	6dB
	Frequency Span	40 MHz
	RBW	100 kHz
	VBW	100 kHz
	Detection	Positive
	SWP	Auto, Normal
	OBW	On
	Trace Point	1001

Table C-4 Standard parameters for OBW function (Cont'd)

Standard	Parameter Name	Setting
ETSI EN 301 893 V1.5.1 OFDM 40MHZ (WLAN)	Method	xdB Down
	XdB Value	6dB
	Frequency Span	80 MHz
	RBW	100 kHz
	VBW	100 kHz
	Detection	Positive
	SWP	Auto, Normal
	OBW	On
	Trace Point	1001
ETSI EN 301 893 V1.5.1 OFDM 80MHZ (WLAN)	Method	N% of Power
	N% Ratio	99.00%
	Frequency Span	160 MHz
	RBW	100 kHz
	VBW	300 kHz
	Detection	Positive
	SWP	Auto, Normal
	OBW	On
	Trace Point	10001
ETSI EN 301 893 V1.5.1 OFDM 160MHZ (WLAN)	Method	N% of Power
	XdB Value	99.00%
	Frequency Span	320 MHz
	RBW	100 kHz
	VBW	300 kHz
	Detection	Positive
	SWP	Auto, Normal
	OBW	On
	Trace Point	10001

C-5 SEM
W-CDMA

Table C-5 Standard parameters for Spectrum Emission Mask

Standard	Parameter Name	Setting
W-CDMA Uplink	Limit Side	Both
	Noise Cancel	Off
	Reference Mode	Channel
	Channel BW	3.84 MHz
	RBW	30 kHz
	Sweep Time	Auto
	Auto Sweep Time Select	Normal
	Detection	RMS
	Trace Point	1001
	Filter Type	Root Nyquist
	Roll-off Factor	0.22
	Offset-1 Start Freq	2.515 MHz
	Offset-2 Start Freq	4 MHz
	Offset-3 Start Freq	7.5 MHz
	Offset-4 Start Freq	8.5 MHz
	Offset-1 Stop Freq	3.485 MHz
	Offset-2 Stop Freq	7.5 MHz
	Offset-3 Stop Freq	8.5 MHz
	Offset-4 Stop Freq	12 MHz
	Offset-1 Reference Level	Auto
	Offset-2 Reference Level	Auto
	Offset-3 Reference Level	Auto
	Offset-4 Reference Level	Auto
	Offset-1 RBW	30 kHz
	Offset-2 RBW	100 kHz
	Offset-3 RBW	1 MHz
Offset-4 RBW	1 MHz	

Table C-5 Standard parameters for Spectrum Emission Mask (Cont'd)

Standard	Parameter Name	Setting
W-CDMA Uplink	Offset-1 Sweep Time	Auto
	Offset-2 Sweep Time	Auto
	Offset-3 Sweep Time	Auto
	Offset-4 Sweep Time	Auto
	Offset-1 Auto Sweep Time Select	Normal
	Offset-2 Auto Sweep Time Select	Normal
	Offset-3 Auto Sweep Time Select	Normal
	Offset-4 Auto Sweep Time Select	Normal
	Offset-1 Detection	RMS
	Offset-2 Detection	RMS
	Offset-3 Detection	RMS
	Offset-4 Detection	RMS
	Offset-1 Trace Point	1001
	Offset-2 Trace Point	10001
	Offset-3 Trace Point	1001
	Offset-4 Trace Point	1001
	Offset-1 Integrate BW	Auto
	Offset-2 Integrate BW	1 MHz
	Offset-3 Integrate BW	Auto
	Offset-4 Integrate BW	Auto

Table C-5 Standard parameters for Spectrum Emission Mask (Cont'd)

Standard	Parameter Name	Setting
W-CDMA Uplink	Offset-1 On/Off	On
	Offset-2 On/Off	On
	Offset-3 On/Off	On
	Offset-4 On/Off	On
	Offset-5 On/Off	Off
	Offset-6 On/Off	Off
	Limit-1 ABS1 Start Level	-69.6 dBm
	Limit-2 ABS1 Start Level	-54.3 dBm
	Limit-3 ABS1 Start Level	-54.3 dBm
	Limit-4 ABS1 Start Level	-54.3 dBm
	Limit-1 ABS1 Stop Level	-69.6 dBm
	Limit-2 ABS1 Stop Level	-54.3 dBm
	Limit-3 ABS1 Stop Level	-54.3 dBm
	Limit-4 ABS1 Stop Level	-54.3 dBm
	Limit-1 ABS2 Start Level	-15 dBm
	Limit-2 ABS2 Start Level	-13 dBm
	Limit-3 ABS2 Start Level	-13 dBm
	Limit-4 ABS2 Start Level	-13 dBm
	Limit-1 ABS2 Stop Level	-15 dBm
	Limit-2 ABS2 Stop Level	-13 dBm
	Limit-3 ABS2 Stop Level	-13 dBm
	Limit-4 ABS2 Stop Level	-13 dBm
	Limit-1 REL Start Level	-33.73 dB
	Limit-2 REL Start Level	-34 dB
	Limit-3 REL Start Level	-37.5 dB
	Limit-4 REL Start Level	-47.5 dB
	Limit-1 REL Stop Level	-48.28 dB
	Limit-2 REL Stop Level	-37.5 dB
	Limit-3 REL Stop Level	-47.5 dB
	Limit-4 REL Stop Level	-47.5 dB
	Limit-1 Fail Logic	ABS1 or REL
	Limit-2 Fail Logic	ABS1 or REL
	Limit-3 Fail Logic	ABS1 or REL
	Limit-4 Fail Logic	ABS1 or REL
Limit-5 Fail Logic	Off	
Limit-6 Fail Logic	Off	

Table C-5 Standard parameters for Spectrum Emission Mask (Cont'd)

Standard	Parameter Name	Setting
W-CDMA Uplink (Additional)	Limit Side	Both
	Noise Cancel	Off
	Reference Mode	Channel
	Channel BW	3.84 MHz
	RBW	30 kHz
	Sweep Time	Auto
	Auto Sweep Time Select	Normal
	Detection	RMS
	Trace Point	1001
	Filter Type	Root Nyquist
	Roll-off Factor	0.22
	Offset-1 Start Freq	2.515 MHz
	Offset-2 Start Freq	4 MHz
	Offset-3 Start Freq	7.5 MHz
	Offset-4 Start Freq	8.5 MHz
	Offset-1 Stop Freq	3.485 MHz
	Offset-2 Stop Freq	7.5 MHz
	Offset-3 Stop Freq	8.5 MHz
	Offset-6 Stop Freq	12 MHz
	Offset-1 Reference Level	Auto
	Offset-2 Reference Level	Auto
	Offset-3 Reference Level	Auto
	Offset-4 Reference Level	Auto
	Offset-1 RBW	30 kHz
	Offset-2 RBW	100 kHz
	Offset-3 RBW	1 MHz
	Offset-4 RBW	1 MHz
	Offset-1 Sweep Time	Auto
	Offset-2 Sweep Time	Auto
	Offset-3 Sweep Time	Auto
Offset-4 Sweep Time	Auto	

Table C-5 Standard parameters for Spectrum Emission Mask (Cont'd)

Standard	Parameter Name	Setting
W-CDMA Uplink (Additional)	Offset-1 Auto Sweep Time Select	Normal
	Offset-2 Auto Sweep Time Select	Normal
	Offset-3 Auto Sweep Time Select	Normal
	Offset-4 Auto Sweep Time Select	Normal
	Offset-1 Detection	RMS
	Offset-2 Detection	RMS
	Offset-3 Detection	RMS
	Offset-4 Detection	RMS
	Offset-1 Trace Point	1001
	Offset-2 Trace Point	10001
	Offset-3 Trace Point	1001
	Offset-4 Trace Point	1001
	Offset-1 Integrate BW	Auto
	Offset-2 Integrate BW	1 MHz
	Offset-3 Integrate BW	Auto
	Offset-4 Integrate BW	Auto
	Offset-1 On/Off	On
	Offset-2 On/Off	On
	Offset-3 On/Off	On
	Offset-4 On/Off	On
	Offset-5 On/Off	Off
	Offset-6 On/Off	Off
	Limit-1 ABS1 Start Level	-69.6 dBm
	Limit-2 ABS1 Start Level	-54.3 dBm
	Limit-3 ABS1 Start Level	-54.3 dBm
	Limit-4 ABS1 Start Level	-54.3 dBm
	Limit-1 ABS1 Stop Level	-69.6 dBm
	Limit-2 ABS1 Stop Level	-54.3 dBm
	Limit-3 ABS1 Stop Level	-54.3 dBm
	Limit-4 ABS1 Stop Level	-54.3 dBm
	Limit-1 ABS2 Start Level	-15 dBm
	Limit-2 ABS2 Start Level	-13 dBm
	Limit-3 ABS2 Start Level	-13 dBm
	Limit-4 ABS2 Start Level	-13 dBm

Table C-5 Standard parameters for Spectrum Emission Mask (Cont'd)

Standard	Parameter Name	Setting
W-CDMA Uplink (Additional)	Limit-1 ABS2 Stop Level	-15 dBm
	Limit-2 ABS2 Stop Level	-13 dBm
	Limit-3 ABS2 Stop Level	-13 dBm
	Limit-4 ABS2 Stop Level	-13 dBm
	Limit-1 REL Start Level	-33.73 dB
	Limit-2 REL Start Level	-34 dB
	Limit-3 REL Start Level	-37.5 dB
	Limit-4 REL Start Level	-47.5 dB
	Limit-1 REL Stop Level	-48.28 dB
	Limit-2 REL Stop Level	-37.5 dB
	Limit-3 REL Stop Level	-47.5 dB
	Limit-4 REL Stop Level	-47.5 dB
	Limit-1 Fail Logic	(ABS1 or REL) and ABS2
	Limit-2 Fail Logic	(ABS1 or REL) and ABS2
	Limit-3 Fail Logic	(ABS1 or REL) and ABS2
	Limit-4 Fail Logic	(ABS1 or REL) and ABS2
	Limit-5 Fail Logic	Off
Limit-6 Fail Logic	Off	

Table C-5 Standard parameters for Spectrum Emission Mask (Cont'd)

Standard	Parameter Name	Setting
W-CDMA Downlink ($P \geq 43\text{dBm}$)	Limit Side	Both
	Noise Cancel	Off
	Reference Mode	Channel
	Channel BW	5 MHz
	RBW	30 kHz
	Sweep Time	Auto
	Auto Sweep Time Select	Normal
	Detection	RMS
	Trace Point	1001
	Filter Type	Rect
	Offset-1 Start Freq	2.515 MHz
	Offset-2 Start Freq	2.715 MHz
	Offset-3 Start Freq	3.515 MHz
	Offset-4 Start Freq	4.0 MHz
	Offset-5 Start Freq	8.0 MHz
	Offset-1 Stop Freq	2.715 MHz
	Offset-2 Stop Freq	3.515 MHz
	Offset-3 Stop Freq	4.0 MHz
	Offset-4 Stop Freq	8.0 MHz
	Offset-5 Stop Freq	12.5 MHz
	Offset-1 Reference Level	Auto
	Offset-2 Reference Level	Auto
	Offset-3 Reference Level	Auto
	Offset-4 Reference Level	Auto
	Offset-5 Reference Level	Auto
	Offset-1 RBW	30 kHz
	Offset-2 RBW	30 kHz
	Offset-3 RBW	30 kHz
Offset-4 RBW	100 kHz	
Offset-5 RBW	1 MHz	

Table C-5 Standard parameters for Spectrum Emission Mask (Cont'd)

Standard	Parameter Name	Setting
W-CDMA Downlink ($P \geq 43\text{dBm}$)	Offset-1 Sweep Time	Auto
	Offset-2 Sweep Time	Auto
	Offset-3 Sweep Time	Auto
	Offset-4 Sweep Time	Auto
	Offset-5 Sweep Time	Auto
	Offset-1 Auto Sweep Time Select	Normal
	Offset-2 Auto Sweep Time Select	Normal
	Offset-3 Auto Sweep Time Select	Normal
	Offset-4 Auto Sweep Time Select	Normal
	Offset-5 Auto Sweep Time Select	Normal
	Offset-1 Detection	RMS
	Offset-2 Detection	RMS
	Offset-3 Detection	RMS
	Offset-4 Detection	RMS
	Offset-5 Detection	RMS
	Offset-1 Trace Point	1001
	Offset-2 Trace Point	1001
	Offset-3 Trace Point	1001
	Offset-4 Trace Point	10001
	Offset-5 Trace Point	1001
	Offset-1 Integrate BW	Auto
	Offset-2 Integrate BW	Auto
	Offset-3 Integrate BW	Auto
Offset-4 Integrate BW	1 MHz	
Offset-5 Integrate BW	Auto	

Table C-5 Standard parameters for Spectrum Emission Mask (Cont'd)

Standard	Parameter Name	Setting
W-CDMA Downlink ($P \geq 43\text{dBm}$)	Offset-1 On/Off	On
	Offset-2 On/Off	On
	Offset-3 On/Off	On
	Offset-4 On/Off	On
	Offset-5 On/Off	On
	Offset-6 On/Off	Off
	Limit-1 ABS1 Start Level	-12.5 dBm
	Limit-2 ABS1 Start Level	-12.5 dBm
	Limit-3 ABS1 Start Level	-24.5 dBm
	Limit-4 ABS1 Start Level	-11.5 dBm
	Limit-5 ABS1 Start Level	-11.5 dBm
	Limit-1 ABS1 Stop Level	-12.5 dBm
	Limit-2 ABS1 Stop Level	-24.5 dBm
	Limit-3 ABS1 Stop Level	-24.5 dBm
	Limit-4 ABS1 Stop Level	-11.5 dBm
	Limit-5 ABS1 Stop Level	-11.5 dBm
	Limit-1 ABS2 Start Level	-15 dBm
	Limit-2 ABS2 Start Level	-15 dBm
	Limit-4 ABS2 Start Level	-13 dBm
	Limit-5 ABS2 Start Level	-13 dBm
	Limit-1 ABS2 Stop Level	-15 dBm
	Limit-2 ABS2 Stop Level	-15 dBm
	Limit-4 ABS2 Stop Level	-13 dBm
	Limit-5 ABS2 Stop Level	-13 dBm
	Limit-1 Fail Logic	ABS1
	Limit-2 Fail Logic	ABS1
	Limit-3 Fail Logic	ABS1
	Limit-4 Fail Logic	ABS1
	Limit-5 Fail Logic	ABS1
	Limit-6 Fail Logic	Off

Table C-5 Standard parameters for Spectrum Emission Mask (Cont'd)

Standard	Parameter Name	Setting
W-CDMA Downlink (P ≥ 43dBm) (Additional)	Limit Side	Both
	Noise Cancel	Off
	Reference Mode	Channel
	Channel BW	5 MHz
	RBW	30 kHz
	Sweep Time	Auto
	Auto Sweep Time Select	Normal
	Detection	RMS
	Trace Point	1001
	Filter Type	Rect
	Offset-1 Start Freq	2.515 MHz
	Offset-2 Start Freq	2.715 MHz
	Offset-3 Start Freq	3.515 MHz
	Offset-4 Start Freq	4.0 MHz
	Offset-5 Start Freq	8.0 MHz
	Offset-1 Stop Freq	2.715 MHz
	Offset-2 Stop Freq	3.515 MHz
	Offset-3 Stop Freq	4.0 MHz
	Offset-4 Stop Freq	8.0 MHz
	Offset-5 Stop Freq	12.5 MHz
	Offset-1 Reference Level	Auto
Offset-2 Reference Level	Auto	
Offset-3 Reference Level	Auto	
Offset-4 Reference Level	Auto	
Offset-5 Reference Level	Auto	

Table C-5 Standard parameters for Spectrum Emission Mask (Cont'd)

Standard	Parameter Name	Setting
W-CDMA Downlink ($P \geq 43\text{dBm}$) (Additional)	Offset-1 RBW	30 kHz
	Offset-2 RBW	30 kHz
	Offset-3 RBW	30 kHz
	Offset-4 RBW	100 kHz
	Offset-5 RBW	1 MHz
	Offset-1 Sweep Time	Auto
	Offset-2 Sweep Time	Auto
	Offset-3 Sweep Time	Auto
	Offset-4 Sweep Time	Auto
	Offset-5 Sweep Time	Auto
	Offset-1 Auto Sweep Time Select	Normal
	Offset-2 Auto Sweep Time Select	Normal
	Offset-3 Auto Sweep Time Select	Normal
	Offset-4 Auto Sweep Time Select	Normal
	Offset-5 Auto Sweep Time Select	Normal
	Offset-1 Detection	RMS
	Offset-2 Detection	RMS
	Offset-3 Detection	RMS
	Offset-4 Detection	RMS
	Offset-5 Detection	RMS
	Offset-1 Trace Point	1001
	Offset-2 Trace Point	1001
	Offset-3 Trace Point	1001
	Offset-4 Trace Point	10001
Offset-5 Trace Point	1001	
Offset-1 Integrate BW	Auto	

Table C-5 Standard parameters for Spectrum Emission Mask (Cont'd)

Standard	Parameter Name	Setting
W-CDMA Downlink ($P \geq 43\text{dBm}$) (Additional)	Offset-2 Integrate BW	Auto
	Offset-3 Integrate BW	Auto
	Offset-4 Integrate BW	1 MHz
	Offset-5 Integrate BW	Auto
	Offset-1 On/Off	On
	Offset-2 On/Off	On
	Offset-3 On/Off	On
	Offset-4 On/Off	On
	Offset-5 On/Off	On
	Offset-6 On/Off	Off
	Limit-1 ABS1 Start Level	-12.5 dBm
	Limit-2 ABS1 Start Level	-12.5 dBm
	Limit-3 ABS1 Start Level	-24.5 dBm
	Limit-4 ABS1 Start Level	-11.5 dBm
	Limit-5 ABS1 Start Level	-11.5 dBm
	Limit-1 ABS1 Stop Level	-12.5 dBm
	Limit-2 ABS1 Stop Level	-24.5 dBm
	Limit-3 ABS1 Stop Level	-24.5 dBm
	Limit-4 ABS1 Stop Level	-11.5 dBm
	Limit-5 ABS1 Stop Level	-11.5 dBm
	Limit-1 ABS2 Start Level	-15 dBm
	Limit-2 ABS2 Start Level	-15 dBm
	Limit-4 ABS2 Start Level	-13 dBm
	Limit-5 ABS2 Start Level	-13 dBm
	Limit-1 ABS2 Stop Level	-15 dBm
	Limit-2 ABS2 Stop Level	-15 dBm
	Limit-4 ABS2 Stop Level	-13 dBm
	Limit-5 ABS2 Stop Level	-13 dBm
	Limit-1 Fail Logic	ABS1 and ABS2
	Limit-2 Fail Logic	ABS1 and ABS2
	Limit-3 Fail Logic	ABS1
	Limit-4 Fail Logic	ABS1 and ABS2
Limit-5 Fail Logic	ABS1 and ABS2	
Limit-6 Fail Logic	Off	

Table C-5 Standard parameters for Spectrum Emission Mask (Cont'd)

Standard	Parameter Name	Setting
W-CDMA Downlink (39dBm ≤ P < 43dBm)	Limit Side	Both
	Noise Cancel	Off
	Reference Mode	Channel
	Channel BW	5 MHz
	RBW	30 kHz
	Sweep Time	Auto
	Auto Sweep Time Select	Normal
	Detection	RMS
	Trace Point	1001
	Filter Type	Rect
	Offset-1 Start Freq	2.515 MHz
	Offset-2 Start Freq	2.715 MHz
	Offset-3 Start Freq	3.515 MHz
	Offset-4 Start Freq	4.0 MHz
	Offset-5 Start Freq	8.0 MHz
	Offset-1 Stop Freq	2.715 MHz
	Offset-2 Stop Freq	3.515 MHz
	Offset-3 Stop Freq	4.0 MHz
	Offset-4 Stop Freq	8.0 MHz
	Offset-5 Stop Freq	12.5 MHz
	Offset-1 Reference Level	Auto
	Offset-2 Reference Level	Auto
	Offset-3 Reference Level	Auto
	Offset-4 Reference Level	Auto
	Offset-5 Reference Level	Auto
	Offset-1 RBW	30 kHz
	Offset-2 RBW	30 kHz
	Offset-3 RBW	30 kHz
Offset-4 RBW	100 kHz	
Offset-5 RBW	1 MHz	

Table C-5 Standard parameters for Spectrum Emission Mask (Cont'd)

Standard	Parameter Name	Setting
W-CDMA Downlink (39dBm ≤ P < 43dBm)	Offset-1 Sweep Time	Auto
	Offset-2 Sweep Time	Auto
	Offset-3 Sweep Time	Auto
	Offset-4 Sweep Time	Auto
	Offset-5 Sweep Time	Auto
	Offset-1 Auto Sweep Time Select	Normal
	Offset-2 Auto Sweep Time Select	Normal
	Offset-3 Auto Sweep Time Select	Normal
	Offset-4 Auto Sweep Time Select	Normal
	Offset-5 Auto Sweep Time Select	Normal
	Offset-1 Detection	RMS
	Offset-2 Detection	RMS
	Offset-3 Detection	RMS
	Offset-4 Detection	RMS
	Offset-5 Detection	RMS
	Offset-1 Trace Point	1001
	Offset-2 Trace Point	1001
	Offset-3 Trace Point	1001
	Offset-4 Trace Point	10001
	Offset-5 Trace Point	1001
	Offset-1 Integrate BW	Auto
	Offset-2 Integrate BW	Auto
	Offset-3 Integrate BW	Auto
Offset-4 Integrate BW	1 MHz	
Offset-5 Integrate BW	Auto	

Table C-5 Standard parameters for Spectrum Emission Mask (Cont'd)

Standard	Parameter Name	Setting
W-CDMA Downlink ($39\text{dBm} \leq P < 43\text{dBm}$)	Offset-1 On/Off	On
	Offset-2 On/Off	On
	Offset-3 On/Off	On
	Offset-4 On/Off	On
	Offset-5 On/Off	On
	Offset-6 On/Off	Off
	Limit-1 ABS1 Start Level	-12.5 dBm
	Limit-2 ABS1 Start Level	-12.5 dBm
	Limit-3 ABS1 Start Level	-24.5 dBm
	Limit-4 ABS1 Start Level	-11.5 dBm
	Limit-5 ABS1 Start Level	-13 dBm
	Limit-1 ABS1 Stop Level	-12.5 dBm
	Limit-2 ABS1 Stop Level	-24.5 dBm
	Limit-3 ABS1 Stop Level	-24.5 dBm
	Limit-4 ABS1 Stop Level	-11.5 dBm
	Limit-5 ABS1 Stop Level	-13 dBm
	Limit-1 ABS2 Start Level	-15 dBm
	Limit-2 ABS2 Start Level	-15 dBm
	Limit-3 ABS2 Start Level	-13 dBm
	Limit-4 ABS2 Start Level	-13 dBm
	Limit-1 ABS2 Stop Level	-15 dBm
	Limit-2 ABS2 Stop Level	-15 dBm
	Limit-3 ABS2 Stop Level	-13 dBm
	Limit-4 ABS2 Stop Level	-13 dBm
	Limit-5 REL Start Level	-54.5 dB
	Limit-5 REL Stop Level	-54.5 dB
	Limit-1 Fail Logic	ABS1
	Limit-2 Fail Logic	ABS1
	Limit-3 Fail Logic	ABS1
	Limit-4 Fail Logic	ABS1
Limit-5 Fail Logic	REL	
Limit-6 Fail Logic	Off	

Table C-5 Standard parameters for Spectrum Emission Mask (Cont'd)

Standard	Parameter Name	Setting
W-CDMA Downlink (39dBm ≤ P < 43dBm) (Additional)	Limit Side	Both
	Noise Cancel	Off
	Reference Mode	Channel
	Channel BW	5 MHz
	RBW	30 kHz
	Sweep Time	Auto
	Auto Sweep Time Select	Normal
	Detection	RMS
	Trace Point	1001
	Filter Type	Rect
	Offset-1 Start Freq	2.515 MHz
	Offset-2 Start Freq	2.715 MHz
	Offset-3 Start Freq	3.515 MHz
	Offset-4 Start Freq	4.0 MHz
	Offset-5 Start Freq	8.0 MHz
	Offset-1 Stop Freq	2.715 MHz
	Offset-2 Stop Freq	3.515 MHz
	Offset-3 Stop Freq	4.0 MHz
	Offset-4 Stop Freq	8.0 MHz
	Offset-5 Stop Freq	12.5 MHz
	Offset-1 Reference Level	Auto
	Offset-2 Reference Level	Auto
	Offset-3 Reference Level	Auto
	Offset-4 Reference Level	Auto
	Offset-5 Reference Level	Auto
	Offset-1 RBW	30 kHz
	Offset-2 RBW	30 kHz
	Offset-3 RBW	30 kHz
Offset-4 RBW	100 kHz	
Offset-5 RBW	1 MHz	

Table C-5 Standard parameters for Spectrum Emission Mask (Cont'd)

Standard	Parameter Name	Setting
W-CDMA Downlink (39dBm ≤ P < 43dBm) (Additional)	Offset-1 Sweep Time	Auto
	Offset-2 Sweep Time	Auto
	Offset-3 Sweep Time	Auto
	Offset-4 Sweep Time	Auto
	Offset-5 Sweep Time	Auto
	Offset-1 Auto Sweep Time Select	Normal
	Offset-2 Auto Sweep Time Select	Normal
	Offset-3 Auto Sweep Time Select	Normal
	Offset-4 Auto Sweep Time Select	Normal
	Offset-5 Auto Sweep Time Select	Normal
	Offset-1 Detection	RMS
	Offset-2 Detection	RMS
	Offset-3 Detection	RMS
	Offset-4 Detection	RMS
	Offset-5 Detection	RMS
	Offset-1 Trace Point	1001
	Offset-2 Trace Point	1001
	Offset-3 Trace Point	1001
	Offset-4 Trace Point	10001
	Offset-5 Trace Point	1001
	Offset-1 Integrate BW	Auto
	Offset-2 Integrate BW	Auto
	Offset-3 Integrate BW	Auto
Offset-4 Integrate BW	1 MHz	
Offset-5 Integrate BW	Auto	

Table C-5 Standard parameters for Spectrum Emission Mask (Cont'd)

Standard	Parameter Name	Setting
W-CDMA Downlink ($39\text{dBm} \leq P < 43\text{dBm}$) (Additional)	Offset-1 On/Off	On
	Offset-2 On/Off	On
	Offset-3 On/Off	On
	Offset-4 On/Off	On
	Offset-5 On/Off	On
	Offset-6 On/Off	Off
	Limit-1 ABS1 Start Level	-12.5 dBm
	Limit-2 ABS1 Start Level	-12.5 dBm
	Limit-3 ABS1 Start Level	-24.5 dBm
	Limit-4 ABS1 Start Level	-11.5 dBm
	Limit-5 ABS1 Start Level	-13 dBm
	Limit-1 ABS1 Stop Level	-12.5 dBm
	Limit-2 ABS1 Stop Level	-24.5 dBm
	Limit-3 ABS1 Stop Level	-24.5 dBm
	Limit-4 ABS1 Stop Level	-11.5 dBm
	Limit-5 ABS1 Stop Level	-13 dBm
	Limit-1 ABS2 Start Level	-15 dBm
	Limit-2 ABS2 Start Level	-15 dBm
	Limit-3 ABS2 Start Level	-13 dBm
	Limit-4 ABS2 Start Level	-13 dBm
	Limit-1 ABS2 Stop Level	-15 dBm
	Limit-2 ABS2 Stop Level	-15 dBm
	Limit-3 ABS2 Stop Level	-13 dBm
	Limit-4 ABS2 Stop Level	-13 dBm
	Limit-5 REL Start Level	-54.5 dB
	Limit-5 REL Stop Level	-54.5 dB
	Limit-1 Fail Logic	ABS1 and ABS2
	Limit-2 Fail Logic	ABS1 and ABS2
	Limit-3 Fail Logic	ABS1
	Limit-4 Fail Logic	ABS1 and ABS2
Limit-5 Fail Logic	ABS1 and REL	
Limit-6 Fail Logic	Off	

Table C-5 Standard parameters for Spectrum Emission Mask (Cont'd)

Standard	Parameter Name	Setting
W-CDMA Downlink (31dBm ≤ P < 39dBm)	Limit Side	Both
	Noise Cancel	Off
	Reference Mode	Channel
	Channel BW	5 MHz
	RBW	30 kHz
	Sweep Time	Auto
	Auto Sweep Time Select	Normal
	Detection	RMS
	Trace Point	1001
	Filter Type	Rect
	Offset-1 Start Freq	2.515 MHz
	Offset-2 Start Freq	2.715 MHz
	Offset-3 Start Freq	3.515 MHz
	Offset-4 Start Freq	4.0 MHz
	Offset-5 Start Freq	8.0 MHz
	Offset-1 Stop Freq	2.715 MHz
	Offset-2 Stop Freq	3.515 MHz
	Offset-3 Stop Freq	4.0 MHz
	Offset-4 Stop Freq	8.0 MHz
	Offset-5 Stop Freq	12.5 MHz
	Offset-1 Reference Level	Auto
	Offset-2 Reference Level	Auto
	Offset-3 Reference Level	Auto
	Offset-4 Reference Level	Auto
	Offset-5 Reference Level	Auto
	Offset-1 RBW	30 kHz
	Offset-2 RBW	30 kHz
	Offset-3 RBW	30 kHz
Offset-4 RBW	100 kHz	
Offset-5 RBW	1 MHz	

Table C-5 Standard parameters for Spectrum Emission Mask (Cont'd)

Standard	Parameter Name	Setting
W-CDMA Downlink (31dBm ≤ P < 39dBm)	Offset-1 Sweep Time	Auto
	Offset-2 Sweep Time	Auto
	Offset-3 Sweep Time	Auto
	Offset-4 Sweep Time	Auto
	Offset-5 Sweep Time	Auto
	Offset-1 Auto Sweep Time Select	Normal
	Offset-2 Auto Sweep Time Select	Normal
	Offset-3 Auto Sweep Time Select	Normal
	Offset-4 Auto Sweep Time Select	Normal
	Offset-5 Auto Sweep Time Select	Normal
	Offset-1 Detection	RMS
	Offset-2 Detection	RMS
	Offset-3 Detection	RMS
	Offset-4 Detection	RMS
	Offset-5 Detection	RMS
	Offset-1 Trace Point	1001
	Offset-2 Trace Point	1001
	Offset-3 Trace Point	1001
	Offset-4 Trace Point	10001
	Offset-5 Trace Point	1001
	Offset-1 Integrate BW	Auto
	Offset-2 Integrate BW	Auto
	Offset-3 Integrate BW	Auto
	Offset-4 Integrate BW	1 MHz
Offset-5 Integrate BW	Auto	

Table C-5 Standard parameters for Spectrum Emission Mask (Cont'd)

Standard	Parameter Name	Setting
W-CDMA Downlink (31dBm ≤ P < 39dBm)	Offset-1 On/Off	On
	Offset-2 On/Off	On
	Offset-3 On/Off	On
	Offset-4 On/Off	On
	Offset-5 On/Off	On
	Offset-6 On/Off	Off
	Limit-1 ABS1 Start Level	-15 dBm
	Limit-2 ABS1 Start Level	-15 dBm
	Limit-4 ABS1 Start Level	-13 dBm
	Limit-5 ABS1 Start Level	-13 dBm
	Limit-1 ABS1 Stop Level	-15 dBm
	Limit-2 ABS1 Stop Level	-15 dBm
	Limit-4 ABS1 Stop Level	-13 dBm
	Limit-5 ABS1 Stop Level	-13 dBm
	Limit-1 REL Start Level	-51.5 dB
	Limit-2 REL Start Level	-51.5 dB
	Limit-3 REL Start Level	-63.5 dB
	Limit-4 REL Start Level	-50.5 dB
	Limit-5 REL Start Level	-54.5 dB
	Limit-1 REL Stop Level	-51.5 dB
	Limit-2 REL Stop Level	-63.5 dB
	Limit-3 REL Stop Level	-63.5 dB
	Limit-4 REL Stop Level	-50.5 dB
	Limit-5 REL Stop Level	-54.5 dB
	Limit-1 Fail Logic	REL
	Limit-2 Fail Logic	REL
	Limit-3 Fail Logic	REL
	Limit-4 Fail Logic	REL
	Limit-5 Fail Logic	REL
	Limit-6 Fail Logic	Off

Table C-5 Standard parameters for Spectrum Emission Mask (Cont'd)

Standard	Parameter Name	Setting
W-CDMA Downlink (31dBm ≤ P < 39dBm) (Additional)	Limit Side	Both
	Noise Cancel	Off
	Reference Mode	Channel
	Channel BW	5 MHz
	RBW	30 kHz
	Sweep Time	Auto
	Auto Sweep Time Select	Normal
	Detection	RMS
	Trace Point	1001
	Filter Type	Rect
	Offset-1 Start Freq	2.515 MHz
	Offset-2 Start Freq	2.715 MHz
	Offset-3 Start Freq	3.515 MHz
	Offset-4 Start Freq	4.0 MHz
	Offset-5 Start Freq	8.0 MHz
	Offset-1 Stop Freq	2.715 MHz
	Offset-2 Stop Freq	3.515 MHz
	Offset-3 Stop Freq	4.0 MHz
	Offset-4 Stop Freq	8.0 MHz
	Offset-5 Stop Freq	12.5 MHz
	Offset-1 Reference Level	Auto
	Offset-2 Reference Level	Auto
	Offset-3 Reference Level	Auto
	Offset-4 Reference Level	Auto
	Offset-5 Reference Level	Auto
	Offset-1 RBW	30 kHz
	Offset-2 RBW	30 kHz
	Offset-3 RBW	30 kHz
Offset-4 RBW	100 kHz	
Offset-5 RBW	1 MHz	

Table C-5 Standard parameters for Spectrum Emission Mask (Cont'd)

Standard	Parameter Name	Setting
W-CDMA Downlink (31dBm ≤ P < 39dBm) (Additional)	Offset-1 Sweep Time	Auto
	Offset-2 Sweep Time	Auto
	Offset-3 Sweep Time	Auto
	Offset-4 Sweep Time	Auto
	Offset-5 Sweep Time	Auto
	Offset-1 Auto Sweep Time Select	Normal
	Offset-2 Auto Sweep Time Select	Normal
	Offset-3 Auto Sweep Time Select	Normal
	Offset-4 Auto Sweep Time Select	Normal
	Offset-5 Auto Sweep Time Select	Normal
	Offset-1 Detection	RMS
	Offset-2 Detection	RMS
	Offset-3 Detection	RMS
	Offset-4 Detection	RMS
	Offset-5 Detection	RMS
	Offset-1 Trace Point	1001
	Offset-2 Trace Point	1001
	Offset-3 Trace Point	1001
	Offset-4 Trace Point	10001
	Offset-5 Trace Point	1001
	Offset-1 Integrate BW	Auto
	Offset-2 Integrate BW	Auto
	Offset-3 Integrate BW	Auto
Offset-4 Integrate BW	1 MHz	
Offset-5 Integrate BW	Auto	

Table C-5 Standard parameters for Spectrum Emission Mask (Cont'd)

Standard	Parameter Name	Setting
W-CDMA Downlink (31dBm ≤ P < 39dBm) (Additional)	Offset-1 On/Off	On
	Offset-2 On/Off	On
	Offset-3 On/Off	On
	Offset-4 On/Off	On
	Offset-5 On/Off	On
	Offset-6 On/Off	Off
	Limit-1 ABS1 Start Level	-15 dBm
	Limit-2 ABS1 Start Level	-15 dBm
	Limit-4 ABS1 Start Level	-13 dBm
	Limit-5 ABS1 Start Level	-13 dBm
	Limit-1 ABS1 Stop Level	-15 dBm
	Limit-2 ABS1 Stop Level	-15 dBm
	Limit-4 ABS1 Stop Level	-13 dBm
	Limit-5 ABS1 Stop Level	-13 dBm
	Limit-1 REL Start Level	-51.5 dB
	Limit-2 REL Start Level	-51.5 dB
	Limit-3 REL Start Level	-63.5 dB
	Limit-4 REL Start Level	-50.5 dB
	Limit-5 REL Start Level	-54.5 dB
	Limit-1 REL Stop Level	-51.5 dB
	Limit-2 REL Stop Level	-63.5 dB
	Limit-3 REL Stop Level	-63.5 dB
	Limit-4 REL Stop Level	-50.5 dB
	Limit-5 REL Stop Level	-54.5 dB
	Limit-1 Fail Logic	ABS1 and REL
	Limit-2 Fail Logic	ABS1 and REL
	Limit-3 Fail Logic	REL
	Limit-4 Fail Logic	ABS1 and REL
	Limit-5 Fail Logic	ABS1 and REL
	Limit-6 Fail Logic	Off

Table C-5 Standard parameters for Spectrum Emission Mask (Cont'd)

Standard	Parameter Name	Setting
W-CDMA Downlink (P < 31dBm)	Limit Side	Both
	Noise Cancel	Off
	Reference Mode	Channel
	Channel BW	5 MHz
	RBW	30 kHz
	Sweep Time	Auto
	Auto Sweep Time Select	Normal
	Detection	RMS
	Trace Point	1001
	Filter Type	Rect
	Offset-1 Start Freq	2.515 MHz
	Offset-2 Start Freq	2.715 MHz
	Offset-3 Start Freq	3.515 MHz
	Offset-4 Start Freq	4.0 MHz
	Offset-5 Start Freq	8.0 MHz
	Offset-1 Stop Freq	2.715 MHz
	Offset-2 Stop Freq	3.515 MHz
	Offset-3 Stop Freq	4.0 MHz
	Offset-4 Stop Freq	8.0 MHz
	Offset-5 Stop Freq	12.5 MHz
	Offset-1 Reference Level	Auto
	Offset-2 Reference Level	Auto
	Offset-3 Reference Level	Auto
	Offset-4 Reference Level	Auto
	Offset-5 Reference Level	Auto
	Offset-1 RBW	30 kHz
	Offset-2 RBW	30 kHz
	Offset-3 RBW	30 kHz
Offset-4 RBW	100 kHz	
Offset-5 RBW	1 MHz	

Table C-5 Standard parameters for Spectrum Emission Mask (Cont'd)

Standard	Parameter Name	Setting
W-CDMA Downlink (P < 31dBm)	Offset-1 Sweep Time	Auto
	Offset-2 Sweep Time	Auto
	Offset-3 Sweep Time	Auto
	Offset-4 Sweep Time	Auto
	Offset-5 Sweep Time	Auto
	Offset-1 Auto Sweep Time Select	Normal
	Offset-2 Auto Sweep Time Select	Normal
	Offset-3 Auto Sweep Time Select	Normal
	Offset-4 Auto Sweep Time Select	Normal
	Offset-5 Auto Sweep Time Select	Normal
	Offset-1 Detection	RMS
	Offset-2 Detection	RMS
	Offset-3 Detection	RMS
	Offset-4 Detection	RMS
	Offset-5 Detection	RMS
	Offset-1 Trace Point	1001
	Offset-2 Trace Point	1001
	Offset-3 Trace Point	1001
	Offset-4 Trace Point	10001
	Offset-5 Trace Point	1001
	Offset-1 Integrate BW	Auto
	Offset-2 Integrate BW	Auto
	Offset-3 Integrate BW	Auto
	Offset-4 Integrate BW	1 MHz
Offset-5 Integrate BW	Auto	

Table C-5 Standard parameters for Spectrum Emission Mask (Cont'd)

Standard	Parameter Name	Setting
W-CDMA Downlink (P < 31dBm)	Offset-1 On/Off	On
	Offset-2 On/Off	On
	Offset-3 On/Off	On
	Offset-4 On/Off	On
	Offset-5 On/Off	On
	Offset-6 On/Off	Off
	Limit-1 ABS1 Start Level	-20.5 dBm
	Limit-2 ABS1 Start Level	-20.5 dBm
	Limit-3 ABS1 Start Level	-32.5 dBm
	Limit-4 ABS1 Start Level	-19.5 dBm
	Limit-5 ABS1 Start Level	-23.5 dBm
	Limit-1 ABS1 Stop Level	-20.5 dBm
	Limit-2 ABS1 Stop Level	-32.5 dBm
	Limit-3 ABS1 Stop Level	-32.5 dBm
	Limit-4 ABS1 Stop Level	-19.5 dBm
	Limit-5 ABS1 Stop Level	-23.5 dBm
	Limit-1 Fail Logic	ABS1
	Limit-2 Fail Logic	ABS1
	Limit-3 Fail Logic	ABS1
	Limit-4 Fail Logic	ABS1
	Limit-5 Fail Logic	ABS1
Limit-6 Fail Logic	Off	

Mobile WiMAX

Table C-5 Standard parameters for Spectrum Emission Mask (Cont'd)

Standard	Parameter Name	Setting
Mobile WiMAX Downlink 5MHz BW	Limit Side	Both
	Noise Cancel	Off
	Reference Mode	Channel
	Channel BW	5 MHz
	RBW	1 MHz
	Sweep Time	Auto
	Auto Sweep Time Select	Normal
	Detection	RMS
	Trace Point	1001
	Filter Type	Rect
	Offset-1 Start Freq	2.5 MHz
	Offset-2 Start Freq	3.5 MHz
	Offset-1 Stop Freq	3.5 MHz
	Offset-2 Stop Freq	12.5 MHz
	Offset-1 Reference Level	Auto
	Offset-2 Reference Level	Auto
	Offset-1 RBW	10 kHz
	Offset-2 RBW	100 kHz
	Offset-1 Sweep Time	Auto
	Offset-2 Sweep Time	Auto
	Offset-1 Auto Sweep Time Select	Normal
	Offset-2 Auto Sweep Time Select	Normal
	Offset-1 Detection	RMS
	Offset-2 Detection	RMS
	Offset-1 Trace Point	1001
	Offset-2 Trace Point	1001
	Offset-1 Integrate BW	50 kHz
	Offset-2 Integrate BW	1 MHz
	Offset-1 On/Off	On
	Offset-2 On/Off	On
	Limit-1 ABS1 Start Level	-13.0 dBm
	Limit-2 ABS1 Start Level	-13.0 dBm
Limit-1 ABS1 Stop Level	-13.0 dBm	
Limit-2 ABS1 Stop Level	-13.0 dBm	
Limit-Fail Logic	ABS1	

Table C-5 Standard parameters for Spectrum Emission Mask (Cont'd)

Standard	Parameter Name	Setting
Mobile WiMAX Uplink 5MHz BW	Limit Side	Both
	Noise Cancel	Off
	Reference Mode	Channel
	Channel BW	5 MHz
	RBW	1 MHz
	VBW	Auto
	Sweep Time	Auto
	Auto Sweep Time Select	Normal
	Detection	Positive
	Trace Point	1001
	Filter Type	Rect
	Offset-1 Start Freq	2.5 MHz
	Offset-2 Start Freq	3.5 MHz
	Offset-3 Start Freq	7.5 MHz
	Offset-4 Start Freq	8 MHz
	Offset-5 Start Freq	10.4 MHz
	Offset-1 Stop Freq	3.5 MHz
	Offset-2 Stop Freq	7.5 MHz
	Offset-3 Stop Freq	8 MHz
	Offset-4 Stop Freq	10.4 MHz
	Offset-5 Stop Freq	12.5 MHz
	Offset-Reference Level	Auto
	Offset-1 RBW	10 kHz
	Offset-2 RBW	100 kHz
	Offset-3, 4, 5 RBW	1 MHz
	Offset-Sweep Time	Auto
	Offset-Auto Sweep Time	Normal
	Offset-Detection	RMS
	Offset-Trace Point	1001
	Offset-1 Integrate BW	50 kHz
	Offset-2 Integrate BW	1 MHz
	Offset-3, 4, 5 Integrate BW	Auto
Offset-1 / 2 / 3 / 4 / 5 On/Off	On	
Offset-6 On/Off	Off	

Table C-5 Standard parameters for Spectrum Emission Mask (Cont'd)

Standard	Parameter Name	Setting
Mobile WiMAX Uplink 5MHz BW	Limit-1 ABS1 Start Level	-13.0 dBm
	Limit-2 ABS1 Start Level	-13.0 dBm
	Limit-3 ABS1 Start Level	-20.0 dBm
	Limit-4 ABS1 Start Level	-25.0 dBm
	Limit-5 ABS1 Start Level	-25.03 dBm
	Limit-1 ABS1 Stop Level	-13.0 dBm
	Limit-2 ABS1 Stop Level	-13.0 dBm
	Limit-3 ABS1 Stop Level	-21.14 dBm
	Limit-4 ABS1 Stop Level	-25.0 dBm
	Limit-5 ABS1 Stop Level	-28.56 dBm
	Limit-Fail Logic	ABS1

Table C-5 Standard parameters for Spectrum Emission Mask (Cont'd)

Standard	Parameter Name	Setting
Mobile WiMAX Downlink 10MHz BW	Limit Side	Both
	Noise Cancel	Off
	Reference Mode	Channel
	Channel BW	10 MHz
	RBW	1 MHz
	Sweep Time	Auto
	Auto Sweep Time Select	Normal
	Detection	RMS
	Trace Point	1001
	Filter Type	Rect
	Offset-1 Start Freq	5 MHz
	Offset-2 Start Freq	6 MHz
	Offset-1 Stop Freq	6 MHz
	Offset-2 Stop Freq	25.0 MHz
	Offset-1 Reference Level	Auto
	Offset-2 Reference Level	Auto
	Offset-1 RBW	100 kHz
	Offset-2 RBW	100 kHz
	Offset-1 Sweep Time	Auto
	Offset-2 Sweep Time	Auto
	Offset-1 Auto Sweep Time Select	Normal
	Offset-2 Auto Sweep Time Select	Normal
	Offset-1 Detection	RMS
	Offset-2 Detection	RMS
	Offset-1 Trace Point	1001
	Offset-2 Trace Point	1001
	Offset-1 Integrate BW	Auto
	Offset-2 Integrate BW	1 MHz
	Offset-1 On/Off	On
	Offset-2 On/Off	On
	Limit-1 ABS1 Start Level	-13.0 dBm
	Limit-2 ABS1 Start Level	-13.0 dBm
	Limit-1 ABS1 Stop Level	-13.0 dBm
Limit-2 ABS1 Stop Level	-13.0 dBm	
Limit-1 Fail Logic	ABS1	
Limit-2 Fail Logic	ABS1	

Table C-5 Standard parameters for Spectrum Emission Mask (Cont'd)

Standard	Parameter Name	Setting
Mobile WiMAX Uplink 10MHz BW	Limit Side	Both
	Noise Cancel	Off
	Reference Mode	Channel
	Channel BW	10 MHz
	RBW	1 MHz
	VBW	Auto
	Sweep Time	Auto
	Auto Sweep Time Select	Normal
	Detection	Positive
	Trace Point	1001
	Filter Type	Rect
	Offset-1 Start Freq	5 MHz
	Offset-2 Start Freq	6 MHz
	Offset-3 Start Freq	10 MHz
	Offset-4 Start Freq	11 MHz
	Offset-5 Start Freq	15 MHz
	Offset-6 Start Freq	20 MHz
	Offset-1 Stop Freq	6 MHz
	Offset-2 Stop Freq	10 MHz
	Offset-3 Stop Freq	11 MHz
	Offset-4 Stop Freq	15 MHz
	Offset-5 Stop Freq	20 MHz
	Offset-6 Stop Freq	25 MHz
	Offset-Reference Level	Auto
	Offset-1 RBW	100 kHz
	Offset-2 RBW	100 kHz
	Offset-3, 4, 5 RBW	1 MHz
	Offset-Sweep Time	Auto
	Offset-Auto Sweep Time	Normal
	Offset-Detection	RMS
	Offset-Trace Point	1001
	Offset-1 Integrate BW	Auto
	Offset-2 Integrate BW	1 MHz
Offset-3,4,5 Integrate BW	Auto	
Offset-On/Off	On	

Table C-5 Standard parameters for Spectrum Emission Mask (Cont'd)

Standard	Parameter Name	Setting
Mobile WiMAX Uplink 10MHz BW	Limit-1 ABS1 Start Level	-13.0 dBm
	Limit-2 ABS1 Start Level	-13.0 dBm
	Limit-3 ABS1 Start Level	-13.0 dBm
	Limit-4 ABS1 Start Level	-25.0 dBm
	Limit-5 ABS1 Start Level	-28.57 dBm
	Limit-6 ABS1 Start Level	-37.0 dBm
	Limit-1 ABS1 Stop Level	-13.0 dBm
	Limit-2 ABS1 Stop Level	-13.0 dBm
	Limit-3 ABS1 Stop Level	-25.0 dBm
	Limit-4 ABS1 Stop Level	-25.0 dBm
	Limit-5 ABS1 Stop Level	-37.0 dBm
	Limit-6 ABS1 Start Level	-37.0 dBm
	Limit-Fail Logic	ABS1

LTE/LTE TDD Downlink

Table C-5 Standard parameters for Spectrum Emission Mask (Cont'd)

Standard	Parameter Name	Setting
LTE Downlink (CategoryA < 1GHz 1.4MHz BW) LTE TDD Downlink (CategoryA < 1GHz 1.4MHz BW)	Limit Side	Both
	Noise Cancel	Off
	Reference Mode	Channel
	Channel BW	1.4 MHz
	RBW	30 kHz
	Sweep Time	Auto
	Auto Sweep Time Select	Normal
	Detection	RMS
	Trace Point	1001
	Filter Type	Rect
	Offset-1 Start Freq	0.750 MHz
	Offset-2 Start Freq	2.150 MHz
	Offset-1 Stop Freq	2.150 MHz
	Offset-2 Stop Freq	3.550 MHz
	Offset-1 Reference Level	Auto
	Offset-2 Reference Level	Auto
	Offset-1 RBW	100 kHz
	Offset-2 RBW	100 kHz
	Offset-1 Sweep Time	Auto
	Offset-2 Sweep Time	Auto
	Offset-1 Auto Sweep Time Select	Normal
	Offset-2 Auto Sweep Time Select	Normal
	Offset-1 Detection	RMS
	Offset-2 Detection	RMS
	Offset-1 Trace Point	1001
	Offset-2 Trace Point	1001
	Offset-1 Integrate BW	Auto
	Offset-2 Integrate BW	Auto

Table C-5 Standard parameters for Spectrum Emission Mask (Cont'd)

Standard	Parameter Name	Setting
LTE Downlink (CategoryA < 1GHz 1.4MHz BW) LTE TDD Downlink (CategoryA < 1GHz 1.4MHz BW)	Offset-1 On/Off	On
	Offset-2 On/Off	On
	Offset-3 On/Off	Off
	Offset-4 On/Off	Off
	Offset-5 On/Off	Off
	Offset-6 On/Off	Off
	Limit-1 ABS1 Start Level	0.5 dBm
	Limit-2 ABS1 Start Level	-9.5 dBm
	Limit-1 ABS1 Stop Level	-9.5 dBm
	Limit-2 ABS1 Stop Level	-9.5 dBm
	Limit-1 ABS2 Start Level	0.5 dBm
	Limit-2 ABS2 Start Level	-9.5 dBm
	Limit-1 ABS2 Stop Level	-9.5 dBm
	Limit-2 ABS2 Stop Level	-9.5 dBm
	Limit-1 Fail Logic	ABS1
	Limit-2 Fail Logic	ABS1
	Limit-3 Fail Logic	Off
	Limit-4 Fail Logic	Off
Limit-5 Fail Logic	Off	
Limit-6 Fail Logic	Off	

Table C-5 Standard parameters for Spectrum Emission Mask (Cont'd)

Standard	Parameter Name	Setting
LTE Downlink (CategoryA < 1GHz 3MHz BW) LTE TDD Downlink (CategoryA < 1GHz 3MHz BW)	Limit Side	Both
	Noise Cancel	Off
	Reference Mode	Channel
	Channel BW	3 MHz
	RBW	30 kHz
	Sweep Time	Auto
	Auto Sweep Time Select	Normal
	Detection	RMS
	Trace Point	1001
	Filter Type	Rect
	Offset-1 Start Freq	1.550 MHz
	Offset-2 Start Freq	4.550 MHz
	Offset-1 Stop Freq	4.550 MHz
	Offset-2 Stop Freq	7.550 MHz
	Offset-1 Reference Level	Auto
	Offset-2 Reference Level	Auto
	Offset-1 RBW	100 kHz
	Offset-2 RBW	100 kHz
	Offset-1 Sweep Time	Auto
	Offset-2 Sweep Time	Auto
	Offset-1 Auto Sweep Time Select	Normal
	Offset-2 Auto Sweep Time Select	Normal
	Offset-1 Detection	RMS
	Offset-2 Detection	RMS
	Offset-1 Trace Point	1001
	Offset-2 Trace Point	1001
	Offset-1 Integrate BW	Auto
	Offset-2 Integrate BW	Auto

Table C-5 Standard parameters for Spectrum Emission Mask (Cont'd)

Standard	Parameter Name	Setting
LTE Downlink (CategoryA < 1GHz 3MHz BW) LTE TDD Downlink (CategoryA < 1GHz 3MHz BW)	Offset-1 On/Off	On
	Offset-2 On/Off	On
	Offset-3 On/Off	Off
	Offset-4 On/Off	Off
	Offset-5 On/Off	Off
	Offset-6 On/Off	Off
	Limit-1 ABS1 Start Level	-3.5 dBm
	Limit-2 ABS1 Start Level	-13.5 dBm
	Limit-1 ABS1 Stop Level	-13.5 dBm
	Limit-2 ABS1 Stop Level	-13.5 dBm
	Limit-1 ABS2 Start Level	-3.5 dBm
	Limit-2 ABS2 Start Level	-13.5 dBm
	Limit-1 ABS2 Stop Level	-13.5 dBm
	Limit-2 ABS2 Stop Level	-13.5 dBm
	Limit-1 Fail Logic	ABS1
	Limit-2 Fail Logic	ABS1
	Limit-3 Fail Logic	Off
	Limit-4 Fail Logic	Off
Limit-5 Fail Logic	Off	
Limit-6 Fail Logic	Off	

Table C-5 Standard parameters for Spectrum Emission Mask (Cont'd)

Standard	Parameter Name	Setting
LTE Downlink (CategoryA < 1GHz 5MHz BW) LTE TDD Downlink (CategoryA < 1GHz 5MHz BW)	Limit Side	Both
	Noise Cancel	Off
	Reference Mode	Channel
	Channel BW	5 MHz
	RBW	30 kHz
	Sweep Time	Auto
	Auto Sweep Time Select	Normal
	Detection	RMS
	Trace Point	1001
	Filter Type	Rect
	Offset-1 Start Freq	2.550 MHz
	Offset-2 Start Freq	7.550 MHz
	Offset-1 Stop Freq	7.550 MHz
	Offset-2 Stop Freq	12.550 MHz
	Offset-1 Reference Level	Auto
	Offset-2 Reference Level	Auto
	Offset-1 RBW	100 kHz
	Offset-2 RBW	100 kHz
	Offset-1 Sweep Time	Auto
	Offset-2 Sweep Time	Auto
	Offset-1 Auto Sweep Time Select	Normal
	Offset-2 Auto Sweep Time Select	Normal
	Offset-1 Detection	RMS
	Offset-2 Detection	RMS
	Offset-1 Trace Point	1001
	Offset-2 Trace Point	1001
	Offset-1 Integrate BW	Auto
	Offset-2 Integrate BW	Auto

Table C-5 Standard parameters for Spectrum Emission Mask (Cont'd)

Standard	Parameter Name	Setting
LTE Downlink (CategoryA < 1GHz 5MHz BW) LTE TDD Downlink (CategoryA < 1GHz 5MHz BW)	Offset-1 On/Off	On
	Offset-2 On/Off	On
	Offset-3 On/Off	Off
	Offset-4 On/Off	Off
	Offset-5 On/Off	Off
	Offset-6 On/Off	Off
	Limit-1 ABS1 Start Level	-5.5 dBm
	Limit-2 ABS1 Start Level	-12.5 dBm
	Limit-1 ABS1 Stop Level	-12.5 dBm
	Limit-2 ABS1 Stop Level	-12.5 dBm
	Limit-1 ABS2 Start Level	-5.5 dBm
	Limit-2 ABS2 Start Level	-12.5 dBm
	Limit-1 ABS2 Stop Level	-12.5 dBm
	Limit-2 ABS2 Stop Level	-12.5 dBm
	Limit-1 Fail Logic	ABS1
	Limit-2 Fail Logic	ABS1
	Limit-3 Fail Logic	Off
	Limit-4 Fail Logic	Off
Limit-5 Fail Logic	Off	
Limit-6 Fail Logic	Off	

Table C-5 Standard parameters for Spectrum Emission Mask (Cont'd)

Standard	Parameter Name	Setting
LTE Downlink (CategoryA < 1GHz 10MHz BW) LTE TDD Downlink (CategoryA < 1GHz 10MHz BW)	Limit Side	Both
	Noise Cancel	Off
	Reference Mode	Channel
	Channel BW	10 MHz
	RBW	30 kHz
	Sweep Time	Auto
	Auto Sweep Time Select	Normal
	Detection	RMS
	Trace Point	1001
	Filter Type	Rect
	Offset-1 Start Freq	5.050 MHz
	Offset-2 Start Freq	10.050 MHz
	Offset-1 Stop Freq	10.050 MHz
	Offset-2 Stop Freq	15.050 MHz
	Offset-1 Reference Level	Auto
	Offset-2 Reference Level	Auto
	Offset-1 RBW	100 kHz
	Offset-2 RBW	100 kHz
	Offset-1 Sweep Time	Auto
	Offset-2 Sweep Time	Auto
	Offset-1 Auto Sweep Time Select	Normal
	Offset-2 Auto Sweep Time Select	Normal
	Offset-1 Detection	RMS
	Offset-2 Detection	RMS
	Offset-1 Trace Point	1001
	Offset-2 Trace Point	1001
	Offset-1 Integrate BW	Auto
	Offset-2 Integrate BW	Auto

Table C-5 Standard parameters for Spectrum Emission Mask (Cont'd)

Standard	Parameter Name	Setting
LTE Downlink (CategoryA < 1GHz 10MHz BW) LTE TDD Downlink (CategoryA < 1GHz 10MHz BW)	Offset-1 On/Off	On
	Offset-2 On/Off	On
	Offset-3 On/Off	Off
	Offset-4 On/Off	Off
	Offset-5 On/Off	Off
	Offset-6 On/Off	Off
	Limit-1 ABS1 Start Level	-5.5 dBm
	Limit-2 ABS1 Start Level	-12.5 dBm
	Limit-1 ABS1 Stop Level	-12.5 dBm
	Limit-2 ABS1 Stop Level	-12.5 dBm
	Limit-1 ABS2 Start Level	-5.5 dBm
	Limit-2 ABS2 Start Level	-12.5 dBm
	Limit-1 ABS2 Stop Level	-12.5 dBm
	Limit-2 ABS2 Stop Level	-12.5 dBm
	Limit-1 Fail Logic	ABS1
	Limit-2 Fail Logic	ABS1
	Limit-3 Fail Logic	Off
	Limit-4 Fail Logic	Off
Limit-5 Fail Logic	Off	
Limit-6 Fail Logic	Off	

Table C-5 Standard parameters for Spectrum Emission Mask (Cont'd)

Standard	Parameter Name	Setting
LTE Downlink (CategoryA < 1GHz 15MHz BW) LTE TDD Downlink (CategoryA < 1GHz 15MHz BW)	Limit Side	Both
	Noise Cancel	Off
	Reference Mode	Channel
	Channel BW	15 MHz
	RBW	30 kHz
	Sweep Time	Auto
	Auto Sweep Time Select	Normal
	Detection	RMS
	Trace Point	1001
	Filter Type	Rect
	Offset-1 Start Freq	7.550 MHz
	Offset-2 Start Freq	12.550 MHz
	Offset-1 Stop Freq	12.550 MHz
	Offset-2 Stop Freq	17.550 MHz
	Offset-1 Reference Level	Auto
	Offset-2 Reference Level	Auto
	Offset-1 RBW	100 kHz
	Offset-2 RBW	100 kHz
	Offset-1 Sweep Time	Auto
	Offset-2 Sweep Time	Auto
	Offset-1 Auto Sweep Time Select	Normal
	Offset-2 Auto Sweep Time Select	Normal
	Offset-1 Detection	RMS
	Offset-2 Detection	RMS
	Offset-1 Trace Point	1001
	Offset-2 Trace Point	1001
	Offset-1 Integrate BW	Auto
	Offset-2 Integrate BW	Auto

Table C-5 Standard parameters for Spectrum Emission Mask (Cont'd)

Standard	Parameter Name	Setting
LTE Downlink (CategoryA < 1GHz 15MHz BW) LTE TDD Downlink (CategoryA < 1GHz 15MHz BW)	Offset-1 On/Off	On
	Offset-2 On/Off	On
	Offset-3 On/Off	Off
	Offset-4 On/Off	Off
	Offset-5 On/Off	Off
	Offset-6 On/Off	Off
	Limit-1 ABS1 Start Level	-5.5 dBm
	Limit-2 ABS1 Start Level	-12.5 dBm
	Limit-1 ABS1 Stop Level	-12.5 dBm
	Limit-2 ABS1 Stop Level	-12.5 dBm
	Limit-1 ABS2 Start Level	-5.5 dBm
	Limit-2 ABS2 Start Level	-12.5 dBm
	Limit-1 ABS2 Stop Level	-12.5 dBm
	Limit-2 ABS2 Stop Level	-12.5 dBm
	Limit-1 Fail Logic	ABS1
	Limit-2 Fail Logic	ABS1
	Limit-3 Fail Logic	Off
	Limit-4 Fail Logic	Off
Limit-5 Fail Logic	Off	
Limit-6 Fail Logic	Off	

Table C-5 Standard parameters for Spectrum Emission Mask (Cont'd)

Standard	Parameter Name	Setting
LTE Downlink (CategoryA < 1GHz 20MHz BW) LTE TDD Downlink (CategoryA < 1GHz 20MHz BW)	Limit Side	Both
	Noise Cancel	Off
	Reference Mode	Channel
	Channel BW	20 MHz
	RBW	30 kHz
	Sweep Time	Auto
	Auto Sweep Time Select	Normal
	Detection	RMS
	Trace Point	1001
	Filter Type	Rect
	Offset-1 Start Freq	10.050 MHz
	Offset-2 Start Freq	15.050 MHz
	Offset-1 Stop Freq	15.050 MHz
	Offset-2 Stop Freq	20.050 MHz
	Offset-1 Reference Level	Auto
	Offset-2 Reference Level	Auto
	Offset-1 RBW	100 kHz
	Offset-2 RBW	100 kHz
	Offset-1 Sweep Time	Auto
	Offset-2 Sweep Time	Auto
	Offset-1 Auto Sweep Time Select	Normal
	Offset-2 Auto Sweep Time Select	Normal
	Offset-1 Detection	RMS
	Offset-2 Detection	RMS
	Offset-1 Trace Point	1001
	Offset-2 Trace Point	1001
	Offset-1 Integrate BW	Auto
	Offset-2 Integrate BW	Auto

Table C-5 Standard parameters for Spectrum Emission Mask (Cont'd)

Standard	Parameter Name	Setting
LTE Downlink (CategoryA < 1GHz 20MHz BW) LTE TDD Downlink (CategoryA < 1GHz 20MHz BW)	Offset-1 On/Off	On
	Offset-2 On/Off	On
	Offset-3 On/Off	Off
	Offset-4 On/Off	Off
	Offset-5 On/Off	Off
	Offset-6 On/Off	Off
	Limit-1 ABS1 Start Level	-5.5 dBm
	Limit-2 ABS1 Start Level	-12.5 dBm
	Limit-1 ABS1 Stop Level	-12.5 dBm
	Limit-2 ABS1 Stop Level	-12.5 dBm
	Limit-1 ABS2 Start Level	-5.5 dBm
	Limit-2 ABS2 Start Level	-12.5 dBm
	Limit-1 ABS2 Stop Level	-12.5 dBm
	Limit-2 ABS2 Stop Level	-12.5 dBm
	Limit-1 Fail Logic	ABS1
	Limit-2 Fail Logic	ABS1
	Limit-3 Fail Logic	Off
	Limit-4 Fail Logic	Off
Limit-5 Fail Logic	Off	
Limit-6 Fail Logic	Off	

Table C-5 Standard parameters for Spectrum Emission Mask (Cont'd)

Standard	Parameter Name	Setting
LTE Downlink (CategoryA > 1GHz 1.4MHz BW) LTE TDD Downlink (CategoryA > 1GHz 1.4MHz BW)	Limit Side	Both
	Noise Cancel	Off
	Reference Mode	Channel
	Channel BW	1.4 MHz
	RBW	30 kHz
	Sweep Time	Auto
	Auto Sweep Time Select	Normal
	Detection	RMS
	Trace Point	1001
	Filter Type	Rect
	Offset-1 Start Freq	0.750 MHz
	Offset-2 Start Freq	2.150 MHz
	Offset-1 Stop Freq	2.150 MHz
	Offset-2 Stop Freq	3.550 MHz
	Offset-1 Reference Level	Auto
	Offset-2 Reference Level	Auto
	Offset-1 RBW	100 kHz
	Offset-2 RBW	100 kHz
	Offset-1 Sweep Time	Auto
	Offset-2 Sweep Time	Auto
	Offset-1 Auto Sweep Time Select	Normal
	Offset-2 Auto Sweep Time Select	Normal
	Offset-1 Detection	RMS
	Offset-2 Detection	RMS
	Offset-1 Trace Point	1001
	Offset-2 Trace Point	1001
	Offset-1 Integrate BW	Auto
	Offset-2 Integrate BW	Auto

Table C-5 Standard parameters for Spectrum Emission Mask (Cont'd)

Standard	Parameter Name	Setting
LTE Downlink (CategoryA > 1GHz 1.4MHz BW) LTE TDD Downlink (CategoryA > 1GHz 1.4MHz BW)	Offset-1 On/Off	On
	Offset-2 On/Off	On
	Offset-3 On/Off	Off
	Offset-4 On/Off	Off
	Offset-5 On/Off	Off
	Offset-6 On/Off	Off
	Limit-1 ABS1 Start Level	0.5 dBm
	Limit-2 ABS1 Start Level	-9.5 dBm
	Limit-1 ABS1 Stop Level	-9.5 dBm
	Limit-2 ABS1 Stop Level	-9.5 dBm
	Limit-1 ABS2 Start Level	0.5 dBm
	Limit-2 ABS2 Start Level	-9.5 dBm
	Limit-1 ABS2 Stop Level	-9.5 dBm
	Limit-2 ABS2 Stop Level	-9.5 dBm
	Limit-1 Fail Logic	ABS1
	Limit-2 Fail Logic	ABS1
	Limit-3 Fail Logic	Off
	Limit-4 Fail Logic	Off
Limit-5 Fail Logic	Off	
Limit-6 Fail Logic	Off	

Table C-5 Standard parameters for Spectrum Emission Mask (Cont'd)

Standard	Parameter Name	Setting
LTE Downlink (CategoryA > 1GHz 3MHz BW) LTE TDD Downlink (CategoryA > 1GHz 3MHz BW)	Limit Side	Both
	Noise Cancel	Off
	Reference Mode	Channel
	Channel BW	3 MHz
	RBW	30 kHz
	Sweep Time	Auto
	Auto Sweep Time Select	Normal
	Detection	RMS
	Trace Point	1001
	Filter Type	Rect
	Offset-1 Start Freq	1.550 MHz
	Offset-2 Start Freq	4.550 MHz
	Offset-1 Stop Freq	4.550 MHz
	Offset-2 Stop Freq	7.550 MHz
	Offset-1 Reference Level	Auto
	Offset-2 Reference Level	Auto
	Offset-1 RBW	100 kHz
	Offset-2 RBW	100 kHz
	Offset-1 Sweep Time	Auto
	Offset-2 Sweep Time	Auto
	Offset-1 Auto Sweep Time Select	Normal
	Offset-2 Auto Sweep Time Select	Normal
	Offset-1 Detection	RMS
	Offset-2 Detection	RMS
	Offset-1 Trace Point	1001
	Offset-2 Trace Point	1001
	Offset-1 Integrate BW	Auto
	Offset-2 Integrate BW	Auto

Table C-5 Standard parameters for Spectrum Emission Mask (Cont'd)

Standard	Parameter Name	Setting
LTE Downlink (CategoryA > 1GHz 3MHz BW) LTE TDD Downlink (CategoryA > 1GHz 3MHz BW)	Offset-1 On/Off	On
	Offset-2 On/Off	On
	Offset-3 On/Off	Off
	Offset-4 On/Off	Off
	Offset-5 On/Off	Off
	Offset-6 On/Off	Off
	Limit-1 ABS1 Start Level	-3.5 dBm
	Limit-2 ABS1 Start Level	-13.5 dBm
	Limit-1 ABS1 Stop Level	-13.5 dBm
	Limit-2 ABS1 Stop Level	-13.5 dBm
	Limit-1 ABS2 Start Level	-3.5 dBm
	Limit-2 ABS2 Start Level	-13.5 dBm
	Limit-1 ABS2 Stop Level	-13.5 dBm
	Limit-2 ABS2 Stop Level	-13.5 dBm
	Limit-1 Fail Logic	ABS1
	Limit-2 Fail Logic	ABS1
	Limit-3 Fail Logic	Off
	Limit-4 Fail Logic	Off
Limit-5 Fail Logic	Off	
Limit-6 Fail Logic	Off	

Table C-5 Standard parameters for Spectrum Emission Mask (Cont'd)

Standard	Parameter Name	Setting
LTE Downlink (CategoryA > 1GHz 5MHz BW) LTE TDD Downlink (CategoryA > 1GHz 5MHz BW)	Limit Side	Both
	Noise Cancel	Off
	Reference Mode	Channel
	Channel BW	5 MHz
	RBW	30 kHz
	Sweep Time	Auto
	Auto Sweep Time Select	Normal
	Detection	RMS
	Trace Point	1001
	Filter Type	Rect
	Offset-1 Start Freq	2.550 MHz
	Offset-2 Start Freq	7.550 MHz
	Offset-1 Stop Freq	7.550 MHz
	Offset-2 Stop Freq	12.550 MHz
	Offset-1 Reference Level	Auto
	Offset-2 Reference Level	Auto
	Offset-1 RBW	100 kHz
	Offset-2 RBW	100 kHz
	Offset-1 Sweep Time	Auto
	Offset-2 Sweep Time	Auto
	Offset-1 Auto Sweep Time Select	Normal
	Offset-2 Auto Sweep Time Select	Normal
	Offset-1 Detection	RMS
	Offset-2 Detection	RMS
	Offset-1 Trace Point	1001
	Offset-2 Trace Point	1001
	Offset-1 Integrate BW	Auto
	Offset-2 Integrate BW	Auto

Table C-5 Standard parameters for Spectrum Emission Mask (Cont'd)

Standard	Parameter Name	Setting
LTE Downlink (CategoryA > 1GHz 5MHz BW) LTE TDD Downlink (CategoryA > 1GHz 5MHz BW)	Offset-1 On/Off	On
	Offset-2 On/Off	On
	Offset-3 On/Off	Off
	Offset-4 On/Off	Off
	Offset-5 On/Off	Off
	Offset-6 On/Off	Off
	Limit-1 ABS1 Start Level	-5.5 dBm
	Limit-2 ABS1 Start Level	-12.5 dBm
	Limit-1 ABS1 Stop Level	-12.5 dBm
	Limit-2 ABS1 Stop Level	-12.5 dBm
	Limit-1 ABS2 Start Level	-5.5 dBm
	Limit-2 ABS2 Start Level	-12.5 dBm
	Limit-1 ABS2 Stop Level	-12.5 dBm
	Limit-2 ABS2 Stop Level	-12.5 dBm
	Limit-1 Fail Logic	ABS1
	Limit-2 Fail Logic	ABS1
	Limit-3 Fail Logic	Off
	Limit-4 Fail Logic	Off
Limit-5 Fail Logic	Off	
Limit-6 Fail Logic	Off	

Table C-5 Standard parameters for Spectrum Emission Mask (Cont'd)

Standard	Parameter Name	Setting
LTE Downlink (CategoryA > 1GHz 10MHz BW) LTE TDD Downlink (CategoryA > 1GHz 10MHz BW)	Limit Side	Both
	Noise Cancel	Off
	Reference Mode	Channel
	Channel BW	10 MHz
	RBW	30 kHz
	Sweep Time	Auto
	Auto Sweep Time Select	Normal
	Detection	RMS
	Trace Point	1001
	Filter Type	Rect
	Offset-1 Start Freq	5.050 MHz
	Offset-2 Start Freq	10.050 MHz
	Offset-1 Stop Freq	10.050 MHz
	Offset-2 Stop Freq	15.050 MHz
	Offset-1 Reference Level	Auto
	Offset-2 Reference Level	Auto
	Offset-1 RBW	100 kHz
	Offset-2 RBW	100 kHz
	Offset-1 Sweep Time	Auto
	Offset-2 Sweep Time	Auto
	Offset-1 Auto Sweep Time Select	Normal
	Offset-2 Auto Sweep Time Select	Normal
	Offset-1 Detection	RMS
	Offset-2 Detection	RMS
	Offset-1 Trace Point	1001
	Offset-2 Trace Point	1001
	Offset-1 Integrate BW	Auto
	Offset-2 Integrate BW	Auto

Table C-5 Standard parameters for Spectrum Emission Mask (Cont'd)

Standard	Parameter Name	Setting
LTE Downlink (CategoryA > 1GHz 10MHz BW) LTE TDD Downlink (CategoryA > 1GHz 10MHz BW)	Offset-1 On/Off	On
	Offset-2 On/Off	On
	Offset-3 On/Off	Off
	Offset-4 On/Off	Off
	Offset-5 On/Off	Off
	Offset-6 On/Off	Off
	Limit-1 ABS1 Start Level	-5.5 dBm
	Limit-2 ABS1 Start Level	-12.5 dBm
	Limit-1 ABS1 Stop Level	-12.5 dBm
	Limit-2 ABS1 Stop Level	-12.5 dBm
	Limit-1 ABS2 Start Level	-5.5 dBm
	Limit-2 ABS2 Start Level	-12.5 dBm
	Limit-1 ABS2 Stop Level	-12.5 dBm
	Limit-2 ABS2 Stop Level	-12.5 dBm
	Limit-1 Fail Logic	ABS1
	Limit-2 Fail Logic	ABS1
	Limit-3 Fail Logic	Off
	Limit-4 Fail Logic	Off
Limit-5 Fail Logic	Off	
Limit-6 Fail Logic	Off	

Table C-5 Standard parameters for Spectrum Emission Mask (Cont'd)

Standard	Parameter Name	Setting
LTE Downlink (CategoryA > 1GHz 15MHz BW) LTE TDD Downlink (CategoryA > 1GHz 15MHz BW)	Limit Side	Both
	Noise Cancel	Off
	Reference Mode	Channel
	Channel BW	15 MHz
	RBW	30 kHz
	Sweep Time	Auto
	Auto Sweep Time Select	Normal
	Detection	RMS
	Trace Point	1001
	Filter Type	Rect
	Offset-1 Start Freq	7.550 MHz
	Offset-2 Start Freq	12.550 MHz
	Offset-1 Stop Freq	12.550 MHz
	Offset-2 Stop Freq	17.550 MHz
	Offset-1 Reference Level	Auto
	Offset-2 Reference Level	Auto
	Offset-1 RBW	100 kHz
	Offset-2 RBW	100 kHz
	Offset-1 Sweep Time	Auto
	Offset-2 Sweep Time	Auto
	Offset-1 Auto Sweep Time Select	Normal
	Offset-2 Auto Sweep Time Select	Normal
	Offset-1 Detection	RMS
	Offset-2 Detection	RMS
	Offset-1 Trace Point	1001
	Offset-2 Trace Point	1001
	Offset-1 Integrate BW	Auto
	Offset-2 Integrate BW	Auto

Table C-5 Standard parameters for Spectrum Emission Mask (Cont'd)

Standard	Parameter Name	Setting
LTE Downlink (CategoryA > 1GHz 15MHz BW) LTE TDD Downlink (CategoryA > 1GHz 15MHz BW)	Offset-1 On/Off	On
	Offset-2 On/Off	On
	Offset-3 On/Off	Off
	Offset-4 On/Off	Off
	Offset-5 On/Off	Off
	Offset-6 On/Off	Off
	Limit-1 ABS1 Start Level	-5.5 dBm
	Limit-2 ABS1 Start Level	-12.5 dBm
	Limit-1 ABS1 Stop Level	-12.5 dBm
	Limit-2 ABS1 Stop Level	-12.5 dBm
	Limit-1 ABS2 Start Level	-5.5 dBm
	Limit-2 ABS2 Start Level	-12.5 dBm
	Limit-1 ABS2 Stop Level	-12.5 dBm
	Limit-2 ABS2 Stop Level	-12.5 dBm
	Limit-1 Fail Logic	ABS1
	Limit-2 Fail Logic	ABS1
	Limit-3 Fail Logic	Off
	Limit-4 Fail Logic	Off
Limit-5 Fail Logic	Off	
Limit-6 Fail Logic	Off	

Table C-5 Standard parameters for Spectrum Emission Mask (Cont'd)

Standard	Parameter Name	Setting
LTE Downlink (CategoryA > 1GHz 20MHz BW) LTE TDD Downlink (CategoryA > 1GHz 20MHz BW)	Limit Side	Both
	Noise Cancel	Off
	Reference Mode	Channel
	Channel BW	20 MHz
	RBW	30 kHz
	Sweep Time	Auto
	Auto Sweep Time Select	Normal
	Detection	RMS
	Trace Point	1001
	Filter Type	Rect
	Offset-1 Start Freq	10.050 MHz
	Offset-2 Start Freq	15.050 MHz
	Offset-1 Stop Freq	15.050 MHz
	Offset-2 Stop Freq	20.050 MHz
	Offset-1 Reference Level	Auto
	Offset-2 Reference Level	Auto
	Offset-1 RBW	100 kHz
	Offset-2 RBW	100 kHz
	Offset-1 Sweep Time	Auto
	Offset-2 Sweep Time	Auto
	Offset-1 Auto Sweep Time Select	Normal
	Offset-2 Auto Sweep Time Select	Normal
	Offset-1 Detection	RMS
	Offset-2 Detection	RMS
	Offset-1 Trace Point	1001
	Offset-2 Trace Point	1001
	Offset-1 Integrate BW	Auto
	Offset-2 Integrate BW	Auto

Table C-5 Standard parameters for Spectrum Emission Mask (Cont'd)

Standard	Parameter Name	Setting
LTE Downlink (CategoryA > 1GHz 20MHz BW) LTE TDD Downlink (CategoryA > 1GHz 20MHz BW)	Offset-1 On/Off	On
	Offset-2 On/Off	On
	Offset-3 On/Off	Off
	Offset-4 On/Off	Off
	Offset-5 On/Off	Off
	Offset-6 On/Off	Off
	Limit-1 ABS1 Start Level	-5.5 dBm
	Limit-2 ABS1 Start Level	-12.5 dBm
	Limit-1 ABS1 Stop Level	-12.5 dBm
	Limit-2 ABS1 Stop Level	-12.5 dBm
	Limit-1 ABS2 Start Level	-5.5 dBm
	Limit-2 ABS2 Start Level	-12.5 dBm
	Limit-1 ABS2 Stop Level	-12.5 dBm
	Limit-2 ABS2 Stop Level	-12.5 dBm
	Limit-1 Fail Logic	ABS1
	Limit-2 Fail Logic	ABS1
	Limit-3 Fail Logic	Off
	Limit-4 Fail Logic	Off
Limit-5 Fail Logic	Off	
Limit-6 Fail Logic	Off	

Table C-5 Standard parameters for Spectrum Emission Mask (Cont'd)

Standard	Parameter Name	Setting
LTE Downlink (CategoryB < 1GHz 1.4MHz BW) LTE TDD Downlink (CategoryB < 1GHz 1.4MHz BW)	Limit Side	Both
	Noise Cancel	Off
	Reference Mode	Channel
	Channel BW	1.4 MHz
	RBW	30 kHz
	Sweep Time	Auto
	Auto Sweep Time Select	Normal
	Detection	RMS
	Trace Point	1001
	Filter Type	Rect
	Offset-1 Start Freq	0.750 MHz
	Offset-2 Start Freq	2.150 MHz
	Offset-1 Stop Freq	2.150 MHz
	Offset-2 Stop Freq	3.550 MHz
	Offset-1 Reference Level	Auto
	Offset-2 Reference Level	Auto
	Offset-1 RBW	100 kHz
	Offset-2 RBW	100 kHz
	Offset-1 Sweep Time	Auto
	Offset-2 Sweep Time	Auto
	Offset-1 Auto Sweep Time Select	Normal
	Offset-2 Auto Sweep Time Select	Normal
	Offset-1 Detection	RMS
	Offset-2 Detection	RMS
	Offset-1 Trace Point	1001
	Offset-2 Trace Point	1001
	Offset-1 Integrate BW	Auto
Offset-2 Integrate BW	Auto	

Table C-5 Standard parameters for Spectrum Emission Mask (Cont'd)

Standard	Parameter Name	Setting
LTE Downlink (CategoryB < 1GHz 1.4MHz BW) LTE TDD Downlink (CategoryB < 1GHz 1.4MHz BW)	Offset-1 On/Off	On
	Offset-2 On/Off	On
	Offset-3 On/Off	Off
	Offset-4 On/Off	Off
	Offset-5 On/Off	Off
	Offset-6 On/Off	Off
	Limit-1 ABS1 Start Level	0.5 dBm
	Limit-2 ABS1 Start Level	-9.5 dBm
	Limit-1 ABS1 Stop Level	-9.5 dBm
	Limit-2 ABS1 Stop Level	-9.5 dBm
	Limit-1 ABS2 Start Level	0.5 dBm
	Limit-2 ABS2 Start Level	-9.5 dBm
	Limit-1 ABS2 Stop Level	-9.5 dBm
	Limit-2 ABS2 Stop Level	-9.5 dBm
	Limit-1 Fail Logic	ABS1
	Limit-2 Fail Logic	ABS1
	Limit-3 Fail Logic	Off
	Limit-4 Fail Logic	Off
Limit-5 Fail Logic	Off	
Limit-6 Fail Logic	Off	

Table C-5 Standard parameters for Spectrum Emission Mask (Cont'd)

Standard	Parameter Name	Setting
LTE Downlink (CategoryB < 1GHz 3MHz BW) LTE TDD Downlink (CategoryB < 1GHz 3MHz BW)	Limit Side	Both
	Noise Cancel	Off
	Reference Mode	Channel
	Channel BW	3 MHz
	RBW	30 kHz
	Sweep Time	Auto
	Auto Sweep Time Select	Normal
	Detection	RMS
	Trace Point	1001
	Filter Type	Rect
	Offset-1 Start Freq	1.550 MHz
	Offset-2 Start Freq	4.550 MHz
	Offset-1 Stop Freq	4.550 MHz
	Offset-2 Stop Freq	7.550 MHz
	Offset-1 Reference Level	Auto
	Offset-2 Reference Level	Auto
	Offset-1 RBW	100 kHz
	Offset-2 RBW	100 kHz
	Offset-1 Sweep Time	Auto
	Offset-2 Sweep Time	Auto
	Offset-1 Auto Sweep Time Select	Normal
	Offset-2 Auto Sweep Time Select	Normal
	Offset-1 Detection	RMS
	Offset-2 Detection	RMS
	Offset-1 Trace Point	1001
	Offset-2 Trace Point	1001
Offset-1 Integrate BW	Auto	
Offset-2 Integrate BW	Auto	

Table C-5 Standard parameters for Spectrum Emission Mask (Cont'd)

Standard	Parameter Name	Setting
LTE Downlink (CategoryB < 1GHz 3MHz BW) LTE TDD Downlink (CategoryB < 1GHz 3MHz BW)	Offset-1 On/Off	On
	Offset-2 On/Off	On
	Offset-3 On/Off	Off
	Offset-4 On/Off	Off
	Offset-5 On/Off	Off
	Offset-6 On/Off	Off
	Limit-1 ABS1 Start Level	-3.5 dBm
	Limit-2 ABS1 Start Level	-13.5 dBm
	Limit-1 ABS1 Stop Level	-13.5 dBm
	Limit-2 ABS1 Stop Level	-13.5 dBm
	Limit-1 ABS2 Start Level	-3.5 dBm
	Limit-2 ABS2 Start Level	-13.5 dBm
	Limit-1 ABS2 Stop Level	-13.5 dBm
	Limit-2 ABS2 Stop Level	-13.5 dBm
	Limit-1 Fail Logic	ABS1
	Limit-2 Fail Logic	ABS1
	Limit-3 Fail Logic	Off
	Limit-4 Fail Logic	Off
Limit-5 Fail Logic	Off	
Limit-6 Fail Logic	Off	

Table C-5 Standard parameters for Spectrum Emission Mask (Cont'd)

Standard	Parameter Name	Setting
LTE Downlink (CategoryB < 1GHz 5MHz BW) LTE TDD Downlink (CategoryB < 1GHz 5MHz BW)	Limit Side	Both
	Noise Cancel	Off
	Reference Mode	Channel
	Channel BW	5 MHz
	RBW	30 kHz
	Sweep Time	Auto
	Auto Sweep Time Select	Normal
	Detection	RMS
	Trace Point	1001
	Filter Type	Rect
	Offset-1 Start Freq	2.550 MHz
	Offset-2 Start Freq	7.550 MHz
	Offset-1 Stop Freq	7.550 MHz
	Offset-2 Stop Freq	12.550 MHz
	Offset-1 Reference Level	Auto
	Offset-2 Reference Level	Auto
	Offset-1 RBW	100 kHz
	Offset-2 RBW	100 kHz
	Offset-1 Sweep Time	Auto
	Offset-2 Sweep Time	Auto
	Offset-1 Auto Sweep Time Select	Normal
	Offset-2 Auto Sweep Time Select	Normal
	Offset-1 Detection	RMS
	Offset-2 Detection	RMS
	Offset-1 Trace Point	1001
	Offset-2 Trace Point	1001
	Offset-1 Integrate BW	Auto
	Offset-2 Integrate BW	Auto

Table C-5 Standard parameters for Spectrum Emission Mask (Cont'd)

Standard	Parameter Name	Setting
LTE Downlink (CategoryB < 1GHz 5MHz BW) LTE TDD Downlink (CategoryB < 1GHz 5MHz BW)	Offset-1 On/Off	On
	Offset-2 On/Off	On
	Offset-3 On/Off	Off
	Offset-4 On/Off	Off
	Offset-5 On/Off	Off
	Offset-6 On/Off	Off
	Limit-1 ABS1 Start Level	-5.5 dBm
	Limit-2 ABS1 Start Level	-12.5 dBm
	Limit-1 ABS1 Stop Level	-12.5 dBm
	Limit-2 ABS1 Stop Level	-12.5 dBm
	Limit-1 ABS2 Start Level	-5.5 dBm
	Limit-2 ABS2 Start Level	-12.5 dBm
	Limit-1 ABS2 Stop Level	-12.5 dBm
	Limit-2 ABS2 Stop Level	-12.5 dBm
	Limit-1 Fail Logic	ABS1
	Limit-2 Fail Logic	ABS1
	Limit-3 Fail Logic	Off
	Limit-4 Fail Logic	Off
Limit-5 Fail Logic	Off	
Limit-6 Fail Logic	Off	

Table C-5 Standard parameters for Spectrum Emission Mask (Cont'd)

Standard	Parameter Name	Setting
LTE Downlink (CategoryB < 1GHz 10MHz BW) LTE TDD Downlink (CategoryB < 1GHz 10MHz BW)	Limit Side	Both
	Noise Cancel	Off
	Reference Mode	Channel
	Channel BW	10 MHz
	RBW	30 kHz
	Sweep Time	Auto
	Auto Sweep Time Select	Normal
	Detection	RMS
	Trace Point	1001
	Filter Type	Rect
	Offset-1 Start Freq	5.050 MHz
	Offset-2 Start Freq	10.050 MHz
	Offset-1 Stop Freq	10.050 MHz
	Offset-2 Stop Freq	15.050 MHz
	Offset-1 Reference Level	Auto
	Offset-2 Reference Level	Auto
	Offset-1 RBW	100 kHz
	Offset-2 RBW	100 kHz
	Offset-1 Sweep Time	Auto
	Offset-2 Sweep Time	Auto
	Offset-1 Auto Sweep Time Select	Normal
	Offset-2 Auto Sweep Time Select	Normal
	Offset-1 Detection	RMS
	Offset-2 Detection	RMS
	Offset-1 Trace Point	1001
	Offset-2 Trace Point	1001
	Offset-1 Integrate BW	Auto
	Offset-2 Integrate BW	Auto

Table C-5 Standard parameters for Spectrum Emission Mask (Cont'd)

Standard	Parameter Name	Setting
LTE Downlink (CategoryB < 1GHz 10MHz BW) LTE TDD Downlink (CategoryB < 1GHz 10MHz BW)	Offset-1 On/Off	On
	Offset-2 On/Off	On
	Offset-3 On/Off	Off
	Offset-4 On/Off	Off
	Offset-5 On/Off	Off
	Offset-6 On/Off	Off
	Limit-1 ABS1 Start Level	-5.5 dBm
	Limit-2 ABS1 Start Level	-12.5 dBm
	Limit-1 ABS1 Stop Level	-12.5 dBm
	Limit-2 ABS1 Stop Level	-12.5 dBm
	Limit-1 ABS2 Start Level	-5.5 dBm
	Limit-2 ABS2 Start Level	-12.5 dBm
	Limit-1 ABS2 Stop Level	-12.5 dBm
	Limit-2 ABS2 Stop Level	-12.5 dBm
	Limit-1 Fail Logic	ABS1
	Limit-2 Fail Logic	ABS1
	Limit-3 Fail Logic	Off
	Limit-4 Fail Logic	Off
Limit-5 Fail Logic	Off	
Limit-6 Fail Logic	Off	

Table C-5 Standard parameters for Spectrum Emission Mask (Cont'd)

Standard	Parameter Name	Setting
LTE Downlink (CategoryB < 1GHz 15MHz BW) LTE TDD Downlink (CategoryB < 1GHz 15MHz BW)	Limit Side	Both
	Noise Cancel	Off
	Reference Mode	Channel
	Channel BW	15 MHz
	RBW	30 kHz
	Sweep Time	Auto
	Auto Sweep Time Select	Normal
	Detection	RMS
	Trace Point	1001
	Filter Type	Rect
	Offset-1 Start Freq	7.550 MHz
	Offset-2 Start Freq	12.550 MHz
	Offset-1 Stop Freq	12.550 MHz
	Offset-2 Stop Freq	17.550 MHz
	Offset-1 Reference Level	Auto
	Offset-2 Reference Level	Auto
	Offset-1 RBW	100 kHz
	Offset-2 RBW	100 kHz
	Offset-1 Sweep Time	Auto
	Offset-2 Sweep Time	Auto
	Offset-1 Auto Sweep Time Select	Normal
	Offset-2 Auto Sweep Time Select	Normal
	Offset-1 Detection	RMS
	Offset-2 Detection	RMS
	Offset-1 Trace Point	1001
	Offset-2 Trace Point	1001
Offset-1 Integrate BW	Auto	
Offset-2 Integrate BW	Auto	

Table C-5 Standard parameters for Spectrum Emission Mask (Cont'd)

Standard	Parameter Name	Setting
LTE Downlink (CategoryB < 1GHz 15MHz BW) LTE TDD Downlink (CategoryB < 1GHz 15MHz BW)	Offset-1 On/Off	On
	Offset-2 On/Off	On
	Offset-3 On/Off	Off
	Offset-4 On/Off	Off
	Offset-5 On/Off	Off
	Offset-6 On/Off	Off
	Limit-1 ABS1 Start Level	-5.5 dBm
	Limit-2 ABS1 Start Level	-12.5 dBm
	Limit-1 ABS1 Stop Level	-12.5 dBm
	Limit-2 ABS1 Stop Level	-12.5 dBm
	Limit-1 ABS2 Start Level	-5.5 dBm
	Limit-2 ABS2 Start Level	-12.5 dBm
	Limit-1 ABS2 Stop Level	-12.5 dBm
	Limit-2 ABS2 Stop Level	-12.5 dBm
	Limit-1 Fail Logic	ABS1
	Limit-2 Fail Logic	ABS1
	Limit-3 Fail Logic	Off
	Limit-4 Fail Logic	Off
Limit-5 Fail Logic	Off	
Limit-6 Fail Logic	Off	

Table C-5 Standard parameters for Spectrum Emission Mask (Cont'd)

Standard	Parameter Name	Setting
LTE Downlink (CategoryB < 1GHz 20MHz BW) LTE TDD Downlink (CategoryB < 1GHz 20MHz BW)	Limit Side	Both
	Noise Cancel	Off
	Reference Mode	Channel
	Channel BW	20 MHz
	RBW	30 kHz
	Sweep Time	Auto
	Auto Sweep Time Select	Normal
	Detection	RMS
	Trace Point	1001
	Filter Type	Rect
	Offset-1 Start Freq	10.050 MHz
	Offset-2 Start Freq	15.050 MHz
	Offset-1 Stop Freq	15.050 MHz
	Offset-2 Stop Freq	20.050 MHz
	Offset-1 Reference Level	Auto
	Offset-2 Reference Level	Auto
	Offset-1 RBW	100 kHz
	Offset-2 RBW	100 kHz
	Offset-1 Sweep Time	Auto
	Offset-2 Sweep Time	Auto
	Offset-1 Auto Sweep Time Select	Normal
	Offset-2 Auto Sweep Time Select	Normal
	Offset-1 Detection	RMS
	Offset-2 Detection	RMS
	Offset-1 Trace Point	1001
	Offset-2 Trace Point	1001
Offset-1 Integrate BW	Auto	
Offset-2 Integrate BW	Auto	

Table C-5 Standard parameters for Spectrum Emission Mask (Cont'd)

Standard	Parameter Name	Setting
LTE Downlink (CategoryB < 1GHz 20MHz BW) LTE TDD Downlink (CategoryB < 1GHz 20MHz BW)	Offset-1 On/Off	On
	Offset-2 On/Off	On
	Offset-3 On/Off	Off
	Offset-4 On/Off	Off
	Offset-5 On/Off	Off
	Offset-6 On/Off	Off
	Limit-1 ABS1 Start Level	-5.5 dBm
	Limit-2 ABS1 Start Level	-12.5 dBm
	Limit-1 ABS1 Stop Level	-12.5 dBm
	Limit-2 ABS1 Stop Level	-12.5 dBm
	Limit-1 ABS2 Start Level	-5.5 dBm
	Limit-2 ABS2 Start Level	-12.5 dBm
	Limit-1 ABS2 Stop Level	-12.5 dBm
	Limit-2 ABS2 Stop Level	-12.5 dBm
	Limit-1 Fail Logic	ABS1
	Limit-2 Fail Logic	ABS1
	Limit-3 Fail Logic	Off
	Limit-4 Fail Logic	Off
Limit-5 Fail Logic	Off	
Limit-6 Fail Logic	Off	

Table C-5 Standard parameters for Spectrum Emission Mask (Cont'd)

Standard	Parameter Name	Setting
LTE Downlink (CategoryB > 1GHz 1.4MHz BW) LTE TDD Downlink (CategoryB > 1GHz 1.4MHz BW)	Limit Side	Both
	Noise Cancel	Off
	Reference Mode	Channel
	Channel BW	1.4 MHz
	RBW	30 kHz
	Sweep Time	Auto
	Auto Sweep Time Select	Normal
	Detection	RMS
	Trace Point	1001
	Filter Type	Rect
	Offset-1 Start Freq	0.750 MHz
	Offset-2 Start Freq	2.150 MHz
	Offset-1 Stop Freq	2.150 MHz
	Offset-2 Stop Freq	3.550 MHz
	Offset-1 Reference Level	Auto
	Offset-2 Reference Level	Auto
	Offset-1 RBW	100 kHz
	Offset-2 RBW	100 kHz
	Offset-1 Sweep Time	Auto
	Offset-2 Sweep Time	Auto
	Offset-1 Auto Sweep Time Select	Normal
	Offset-2 Auto Sweep Time Select	Normal
	Offset-1 Detection	RMS
	Offset-2 Detection	RMS
	Offset-1 Trace Point	1001
	Offset-2 Trace Point	1001
	Offset-1 Integrate BW	Auto
	Offset-2 Integrate BW	Auto

Table C-5 Standard parameters for Spectrum Emission Mask (Cont'd)

Standard	Parameter Name	Setting
LTE Downlink (CategoryB > 1GHz 1.4MHz BW) LTE TDD Downlink (CategoryB > 1GHz 1.4MHz BW)	Offset-1 On/Off	On
	Offset-2 On/Off	On
	Offset-3 On/Off	Off
	Offset-4 On/Off	Off
	Offset-5 On/Off	Off
	Offset-6 On/Off	Off
	Limit-1 ABS1 Start Level	0.5 dBm
	Limit-2 ABS1 Start Level	-9.5 dBm
	Limit-1 ABS1 Stop Level	-9.5 dBm
	Limit-2 ABS1 Stop Level	-9.5 dBm
	Limit-1 ABS2 Start Level	0.5 dBm
	Limit-2 ABS2 Start Level	-9.5 dBm
	Limit-1 ABS2 Stop Level	-9.5 dBm
	Limit-2 ABS2 Stop Level	-9.5 dBm
	Limit-1 Fail Logic	ABS1
	Limit-2 Fail Logic	ABS1
	Limit-3 Fail Logic	Off
	Limit-4 Fail Logic	Off
Limit-5 Fail Logic	Off	
Limit-6 Fail Logic	Off	

Table C-5 Standard parameters for Spectrum Emission Mask (Cont'd)

Standard	Parameter Name	Setting
LTE Downlink (CategoryB > 1GHz 3MHz BW) LTE TDD Downlink (CategoryB > 1GHz 3MHz BW)	Limit Side	Both
	Noise Cancel	Off
	Reference Mode	Channel
	Channel BW	3 MHz
	RBW	30 kHz
	Sweep Time	Auto
	Auto Sweep Time Select	Normal
	Detection	RMS
	Trace Point	1001
	Filter Type	Rect
	Offset-1 Start Freq	1.550 MHz
	Offset-2 Start Freq	4.550 MHz
	Offset-1 Stop Freq	4.550 MHz
	Offset-2 Stop Freq	7.550 MHz
	Offset-1 Reference Level	Auto
	Offset-2 Reference Level	Auto
	Offset-1 RBW	100 kHz
	Offset-2 RBW	100 kHz
	Offset-1 Sweep Time	Auto
	Offset-2 Sweep Time	Auto
	Offset-1 Auto Sweep Time Select	Normal
	Offset-2 Auto Sweep Time Select	Normal
	Offset-1 Detection	RMS
	Offset-2 Detection	RMS
	Offset-1 Trace Point	1001
	Offset-2 Trace Point	1001
	Offset-1 Integrate BW	Auto
	Offset-2 Integrate BW	Auto

Table C-5 Standard parameters for Spectrum Emission Mask (Cont'd)

Standard	Parameter Name	Setting
LTE Downlink (CategoryB > 1GHz 3MHz BW) LTE TDD Downlink (CategoryB > 1GHz 3MHz BW)	Offset-1 On/Off	On
	Offset-2 On/Off	On
	Offset-3 On/Off	Off
	Offset-4 On/Off	Off
	Offset-5 On/Off	Off
	Offset-6 On/Off	Off
	Limit-1 ABS1 Start Level	-3.5 dBm
	Limit-2 ABS1 Start Level	-13.5 dBm
	Limit-1 ABS1 Stop Level	-13.5 dBm
	Limit-2 ABS1 Stop Level	-13.5 dBm
	Limit-1 ABS2 Start Level	-3.5 dBm
	Limit-2 ABS2 Start Level	-13.5 dBm
	Limit-1 ABS2 Stop Level	-13.5 dBm
	Limit-2 ABS2 Stop Level	-13.5 dBm
	Limit-1 Fail Logic	ABS1
	Limit-2 Fail Logic	ABS1
	Limit-3 Fail Logic	Off
	Limit-4 Fail Logic	Off
Limit-5 Fail Logic	Off	
Limit-6 Fail Logic	Off	

Table C-5 Standard parameters for Spectrum Emission Mask (Cont'd)

Standard	Parameter Name	Setting
LTE Downlink (CategoryB > 1GHz 5MHz BW) LTE TDD Downlink (CategoryB > 1GHz 5MHz BW)	Limit Side	Both
	Noise Cancel	Off
	Reference Mode	Channel
	Channel BW	5 MHz
	RBW	30 kHz
	Sweep Time	Auto
	Auto Sweep Time Select	Normal
	Detection	RMS
	Trace Point	1001
	Filter Type	Rect
	Offset-1 Start Freq	2.550 MHz
	Offset-2 Start Freq	7.550 MHz
	Offset-1 Stop Freq	7.550 MHz
	Offset-2 Stop Freq	12.550 MHz
	Offset-1 Reference Level	Auto
	Offset-2 Reference Level	Auto
	Offset-1 RBW	100 kHz
	Offset-2 RBW	100 kHz
	Offset-1 Sweep Time	Auto
	Offset-2 Sweep Time	Auto
	Offset-1 Auto Sweep Time Select	Normal
	Offset-2 Auto Sweep Time Select	Normal
	Offset-1 Detection	RMS
	Offset-2 Detection	RMS
	Offset-1 Trace Point	1001
	Offset-2 Trace Point	1001
Offset-1 Integrate BW	Auto	
Offset-2 Integrate BW	Auto	

Table C-5 Standard parameters for Spectrum Emission Mask (Cont'd)

Standard	Parameter Name	Setting
LTE Downlink (CategoryB > 1GHz 5MHz BW) LTE TDD Downlink (CategoryB > 1GHz 5MHz BW)	Offset-1 On/Off	On
	Offset-2 On/Off	On
	Offset-3 On/Off	Off
	Offset-4 On/Off	Off
	Offset-5 On/Off	Off
	Offset-6 On/Off	Off
	Limit-1 ABS1 Start Level	-5.5 dBm
	Limit-2 ABS1 Start Level	-12.5 dBm
	Limit-1 ABS1 Stop Level	-12.5 dBm
	Limit-2 ABS1 Stop Level	-12.5 dBm
	Limit-1 ABS2 Start Level	-5.5 dBm
	Limit-2 ABS2 Start Level	-12.5 dBm
	Limit-1 ABS2 Stop Level	-12.5 dBm
	Limit-2 ABS2 Stop Level	-12.5 dBm
	Limit-1 Fail Logic	ABS1
	Limit-2 Fail Logic	ABS1
	Limit-3 Fail Logic	Off
	Limit-4 Fail Logic	Off
Limit-5 Fail Logic	Off	
Limit-6 Fail Logic	Off	

Table C-5 Standard parameters for Spectrum Emission Mask (Cont'd)

Standard	Parameter Name	Setting
LTE Downlink (CategoryB > 1GHz 10MHz BW) LTE TDD Downlink (CategoryB > 1GHz 10MHz BW)	Limit Side	Both
	Noise Cancel	Off
	Reference Mode	Channel
	Channel BW	10 MHz
	RBW	30 kHz
	Sweep Time	Auto
	Auto Sweep Time Select	Normal
	Detection	RMS
	Trace Point	1001
	Filter Type	Rect
	Offset-1 Start Freq	5.050 MHz
	Offset-2 Start Freq	10.050 MHz
	Offset-1 Stop Freq	10.050 MHz
	Offset-2 Stop Freq	15.050 MHz
	Offset-1 Reference Level	Auto
	Offset-2 Reference Level	Auto
	Offset-1 RBW	100 kHz
	Offset-2 RBW	100 kHz
	Offset-1 Sweep Time	Auto
	Offset-2 Sweep Time	Auto
	Offset-1 Auto Sweep Time Select	Normal
	Offset-2 Auto Sweep Time Select	Normal
	Offset-1 Detection	RMS
	Offset-2 Detection	RMS
	Offset-1 Trace Point	1001
	Offset-2 Trace Point	1001
	Offset-1 Integrate BW	Auto
	Offset-2 Integrate BW	Auto

Table C-5 Standard parameters for Spectrum Emission Mask (Cont'd)

Standard	Parameter Name	Setting
LTE Downlink (CategoryB > 1GHz 10MHz BW) LTE TDD Downlink (CategoryB > 1GHz 10MHz BW)	Offset-1 On/Off	On
	Offset-2 On/Off	On
	Offset-3 On/Off	Off
	Offset-4 On/Off	Off
	Offset-5 On/Off	Off
	Offset-6 On/Off	Off
	Limit-1 ABS1 Start Level	-5.5 dBm
	Limit-2 ABS1 Start Level	-12.5 dBm
	Limit-1 ABS1 Stop Level	-12.5 dBm
	Limit-2 ABS1 Stop Level	-12.5 dBm
	Limit-1 ABS2 Start Level	-5.5 dBm
	Limit-2 ABS2 Start Level	-12.5 dBm
	Limit-1 ABS2 Stop Level	-12.5 dBm
	Limit-2 ABS2 Stop Level	-12.5 dBm
	Limit-1 Fail Logic	ABS1
	Limit-2 Fail Logic	ABS1
	Limit-3 Fail Logic	Off
	Limit-4 Fail Logic	Off
Limit-5 Fail Logic	Off	
Limit-6 Fail Logic	Off	

Table C-5 Standard parameters for Spectrum Emission Mask (Cont'd)

Standard	Parameter Name	Setting
LTE Downlink (CategoryB > 1GHz 15MHz BW) LTE TDD Downlink (CategoryB > 1GHz 15MHz BW)	Limit Side	Both
	Noise Cancel	Off
	Reference Mode	Channel
	Channel BW	15 MHz
	RBW	30 kHz
	Sweep Time	Auto
	Auto Sweep Time Select	Normal
	Detection	RMS
	Trace Point	1001
	Filter Type	Rect
	Offset-1 Start Freq	7.550 MHz
	Offset-2 Start Freq	12.550 MHz
	Offset-1 Stop Freq	12.550 MHz
	Offset-2 Stop Freq	17.550 MHz
	Offset-1 Reference Level	Auto
	Offset-2 Reference Level	Auto
	Offset-1 RBW	100 kHz
	Offset-2 RBW	100 kHz
	Offset-1 Sweep Time	Auto
	Offset-2 Sweep Time	Auto
	Offset-1 Auto Sweep Time Select	Normal
	Offset-2 Auto Sweep Time Select	Normal
	Offset-1 Detection	RMS
	Offset-2 Detection	RMS
	Offset-1 Trace Point	1001
	Offset-2 Trace Point	1001
	Offset-1 Integrate BW	Auto
	Offset-2 Integrate BW	Auto

Table C-5 Standard parameters for Spectrum Emission Mask (Cont'd)

Standard	Parameter Name	Setting
LTE Downlink (CategoryB > 1GHz 15MHz BW) LTE TDD Downlink (CategoryB > 1GHz 15MHz BW)	Offset-1 On/Off	On
	Offset-2 On/Off	On
	Offset-3 On/Off	Off
	Offset-4 On/Off	Off
	Offset-5 On/Off	Off
	Offset-6 On/Off	Off
	Limit-1 ABS1 Start Level	-5.5 dBm
	Limit-2 ABS1 Start Level	-12.5 dBm
	Limit-1 ABS1 Stop Level	-12.5 dBm
	Limit-2 ABS1 Stop Level	-12.5 dBm
	Limit-1 ABS2 Start Level	-5.5 dBm
	Limit-2 ABS2 Start Level	-12.5 dBm
	Limit-1 ABS2 Stop Level	-12.5 dBm
	Limit-2 ABS2 Stop Level	-12.5 dBm
	Limit-1 Fail Logic	ABS1
	Limit-2 Fail Logic	ABS1
	Limit-3 Fail Logic	Off
	Limit-4 Fail Logic	Off
Limit-5 Fail Logic	Off	
Limit-6 Fail Logic	Off	

Table C-5 Standard parameters for Spectrum Emission Mask (Cont'd)

Standard	Parameter Name	Setting
LTE Downlink (CategoryB > 1GHz 20MHz BW) LTE TDD Downlink (CategoryB > 1GHz 20MHz BW)	Limit Side	Both
	Noise Cancel	Off
	Reference Mode	Channel
	Channel BW	20 MHz
	RBW	30 kHz
	Sweep Time	Auto
	Auto Sweep Time Select	Normal
	Detection	RMS
	Trace Point	1001
	Filter Type	Rect
	Offset-1 Start Freq	10.050 MHz
	Offset-2 Start Freq	15.050 MHz
	Offset-1 Stop Freq	15.050 MHz
	Offset-2 Stop Freq	20.050 MHz
	Offset-1 Reference Level	Auto
	Offset-2 Reference Level	Auto
	Offset-1 RBW	100 kHz
	Offset-2 RBW	100 kHz
	Offset-1 Sweep Time	Auto
	Offset-2 Sweep Time	Auto
	Offset-1 Auto Sweep Time Select	Normal
	Offset-2 Auto Sweep Time Select	Normal
	Offset-1 Detection	RMS
	Offset-2 Detection	RMS
	Offset-1 Trace Point	1001
	Offset-2 Trace Point	1001
Offset-1 Integrate BW	Auto	
Offset-2 Integrate BW	Auto	

Table C-5 Standard parameters for Spectrum Emission Mask (Cont'd)

Standard	Parameter Name	Setting
LTE Downlink (CategoryB > 1GHz 20MHz BW) LTE TDD Downlink (CategoryB > 1GHz 20MHz BW)	Offset-1 On/Off	On
	Offset-2 On/Off	On
	Offset-3 On/Off	Off
	Offset-4 On/Off	Off
	Offset-5 On/Off	Off
	Offset-6 On/Off	Off
	Limit-1 ABS1 Start Level	-5.5 dBm
	Limit-2 ABS1 Start Level	-12.5 dBm
	Limit-1 ABS1 Stop Level	-12.5 dBm
	Limit-2 ABS1 Stop Level	-12.5 dBm
	Limit-1 ABS2 Start Level	-5.5 dBm
	Limit-2 ABS2 Start Level	-12.5 dBm
	Limit-1 ABS2 Stop Level	-12.5 dBm
	Limit-2 ABS2 Stop Level	-12.5 dBm
	Limit-1 Fail Logic	ABS1
	Limit-2 Fail Logic	ABS1
	Limit-3 Fail Logic	Off
	Limit-4 Fail Logic	Off
Limit-5 Fail Logic	Off	
Limit-6 Fail Logic	Off	

LTE/LTE TDD Uplink

Table C-5 Standard parameters for Spectrum Emission Mask (Cont'd)

Standard	Parameter Name	Setting
LTE Uplink (General 1.4MHz) LTE TDD Uplink (General 1.4MHz)	Limit Side	Both
	Noise Cancel	Off
	Reference Mode	Channel
	Channel BW	1.4 MHz
	RBW	30 kHz
	Sweep Time	500 ms
	Auto Sweep Time Select	Normal
	Detection	RMS
	Trace Point	501
	Filter Type	Rect
	Offset-1 Start Freq	0.715 MHz
	Offset-2 Start Freq	2.2 MHz
	Offset-3 Start Freq	3.699700 MHz
	Offset-1 Stop Freq	1.685 MHz
	Offset-2 Stop Freq	2.7 MHz
	Offset-3 Stop Freq	3.7 MHz
	Offset-1/2/3 Reference Level	Auto
	Offset-1 RBW	30 kHz
	Offset-2 RBW	1 MHz
	Offset-3 RBW	1 MHz
	Offset-1 Sweep Time	400 ms
	Offset-2 Sweep Time	10 ms
	Offset-3 Sweep Time	10 ms
	Offset-1 Auto Sweep Time Select	Normal
	Offset-2 Auto Sweep Time Select	Normal
	Offset-3 Auto Sweep Time Select	Normal
	Offset-1 Detection	RMS
	Offset-2 Detection	RMS
	Offset-3 Detection	RMS
	Offset-1 Trace Point	401
	Offset-2 Trace Point	11
	Offset-3 Trace Point	11
	Offset-1 Integrate BW	Auto
Offset-2 Integrate BW	Auto	
Offset-3 Integrate BW	Auto	

Table C-5 Standard parameters for Spectrum Emission Mask (Cont'd)

Standard	Parameter Name	Setting
LTE Uplink (General 1.4MHz)	Offset-1 On/Off	On
	Offset-2 On/Off	On
	Offset-3 On/Off	On
	Offset-4 On/Off	Off
	Offset-5 On/Off	Off
	Offset-6 On/Off	Off
LTE TDD Uplink (General 1.4MHz) (Cont'd)	Limit-1 ABS1 Start Level	-8.5 dBm
	Limit-2 ABS1 Start Level	-8.5 dBm
	Limit-3 ABS1 Start Level	-23.5 dBm
	Limit-1 ABS1 Stop Level	-8.5 dBm
	Limit-2 ABS1 Stop Level	-8.5 dBm
	Limit-3 ABS1 Stop Level	-23.5 dBm
	Limit-1 Fail Logic	ABS1
	Limit-2 Fail Logic	ABS1
	Limit-3 Fail Logic	ABS1
	Limit-4 Fail Logic	Off
Limit-5 Fail Logic	Off	
Limit-6 Fail Logic	Off	

Table C-5 Standard parameters for Spectrum Emission Mask (Cont'd)

Standard	Parameter Name	Setting
LTE Uplink (General 3MHz)	Limit Side	Both
	Noise Cancel	Off
	Reference Mode	Channel
	Channel BW	3 MHz
	RBW	30 kHz
	Sweep Time	1000 ms
	Auto Sweep Time Select	Normal
	Detection	RMS
	Trace Point	1001
	Filter Type	Rect
	Offset-1 Start Freq	1.515 MHz
	Offset-2 Start Freq	3 MHz
	Offset-3 Start Freq	6.699700 MHz
	Offset-1 Stop Freq	2.485 MHz
	Offset-2 Stop Freq	6 MHz
	Offset-3 Stop Freq	7 MHz
	Offset-1/2/3 Reference Level	Auto
	Offset-1 RBW	30 kHz
	Offset-2 RBW	1 MHz
	Offset-3 RBW	1 MHz
	Offset-1 Sweep Time	400 ms
	Offset-2 Sweep Time	40 ms
	Offset-3 Sweep Time	10 ms
	Offset-1 Auto Sweep Time Select	Normal
	Offset-2 Auto Sweep Time Select	Normal
	Offset-3 Auto Sweep Time Select	Normal
	Offset-1 Detection	RMS
	Offset-2 Detection	RMS
	Offset-3 Detection	RMS
	Offset-1 Trace Point	401
	Offset-2 Trace Point	41
	Offset-3 Trace Point	11
	Offset-1 Integrate BW	Auto
Offset-2 Integrate BW	Auto	
Offset-3 Integrate BW	Auto	
LTE TDD Uplink (General 3MHz)		

Table C-5 Standard parameters for Spectrum Emission Mask (Cont'd)

Standard	Parameter Name	Setting
LTE Uplink (General 3MHz)	Offset-1 On/Off	On
	Offset-2 On/Off	On
	Offset-3 On/Off	On
	Offset-4 On/Off	Off
	Offset-5 On/Off	Off
	Offset-6 On/Off	Off
LTE TDD Uplink (General 3MHz) (Cont'd)	Limit-1 ABS1 Start Level	-11.5 dBm
	Limit-2 ABS1 Start Level	-8.5 dBm
	Limit-3 ABS1 Start Level	-23.5 dBm
	Limit-1 ABS1 Stop Level	-11.5 dBm
	Limit-2 ABS1 Stop Level	-8.5 dBm
	Limit-3 ABS1 Stop Level	-23.5 dBm
	Limit-1 Fail Logic	ABS1
	Limit-2 Fail Logic	ABS1
	Limit-3 Fail Logic	ABS1
	Limit-4 Fail Logic	Off
Limit-5 Fail Logic	Off	
Limit-6 Fail Logic	Off	

Table C-5 Standard parameters for Spectrum Emission Mask (Cont'd)

Standard	Parameter Name	Setting	
LTE Uplink (General 5MHz)	Limit Side	Both	
	Noise Cancel	Off	
	Reference Mode	Channel	
	Channel BW	5 MHz	
	RBW	100 kHz	
	Sweep Time	500 ms	
	Auto Sweep Time Select	Normal	
	Detection	RMS	
	Trace Point	501	
	Filter Type	Rect	
	Offset-1 Start Freq	2.515 MHz	
	Offset-2 Start Freq	4 MHz	
	Offset-3 Start Freq	7.9997 MHz	
	Offset-1 Stop Freq	3.485 MHz	
	Offset-2 Stop Freq	7 MHz	
	Offset-3 Stop Freq	8 MHz	
	Offset-1/2/3 Reference Level	Auto	
	Offset-1 RBW	30 kHz	
	Offset-2 RBW	1 MHz	
	Offset-3 RBW	1 MHz	
	LTE TDD Uplink (General 5MHz)	Offset-1 Sweep Time	400 ms
		Offset-2 Sweep Time	40 ms
		Offset-3 Sweep Time	10 ms
		Offset-1 Auto Sweep Time Select	Normal
		Offset-2 Auto Sweep Time Select	Normal
		Offset-3 Auto Sweep Time Select	Normal
		Offset-1 Detection	RMS
		Offset-2 Detection	RMS
		Offset-3 Detection	RMS
		Offset-1 Trace Point	401
		Offset-2 Trace Point	41
		Offset-3 Trace Point	11
		Offset-1 Integrate BW	Auto
	Offset-2 Integrate BW	Auto	
	Offset-3 Integrate BW	Auto	

Table C-5 Standard parameters for Spectrum Emission Mask (Cont'd)

Standard	Parameter Name	Setting
LTE Uplink (General 5MHz)	Offset-1 On/Off	On
	Offset-2 On/Off	On
	Offset-3 On/Off	On
	Offset-4 On/Off	Off
	Offset-5 On/Off	Off
	Offset-6 On/Off	Off
LTE TDD Uplink (General 5MHz) (Cont'd)	Limit-1 ABS1 Start Level	-13.5 dBm
	Limit-2 ABS1 Start Level	-8.5 dBm
	Limit-3 ABS1 Start Level	-11.5 dBm
	Limit-1 ABS1 Stop Level	-13.5 dBm
	Limit-2 ABS1 Stop Level	-8.5 dBm
	Limit-3 ABS1 Stop Level	-11.5 dBm
	Limit-1 Fail Logic	ABS1
	Limit-2 Fail Logic	ABS1
	Limit-3 Fail Logic	ABS1
	Limit-4 Fail Logic	Off
Limit-5 Fail Logic	Off	
Limit-6 Fail Logic	Off	

Table C-5 Standard parameters for Spectrum Emission Mask (Cont'd)

Standard	Parameter Name	Setting
LTE Uplink (General 10MHz) LTE TDD Uplink (General 10MHz)	Limit Side	Both
	Noise Cancel	Off
	Reference Mode	Channel
	Channel BW	10 MHz
	RBW	300 kHz
	Sweep Time	400 ms
	Auto Sweep Time Select	Normal
	Detection	RMS
	Trace Point	401
	Filter Type	Rect
	Offset-1 Start Freq	5.015 MHz
	Offset-2 Start Freq	6.5 MHz
	Offset-3 Start Freq	10.5 MHz
	Offset-1 Stop Freq	5.985 MHz
	Offset-2 Stop Freq	9.5 MHz
	Offset-3 Stop Freq	14.5 MHz
	Offset-1/2/3 Reference Level	Auto
	Offset-1 RBW	30 kHz
	Offset-2 RBW	1 MHz
	Offset-3 RBW	1 MHz
	Offset-1 Sweep Time	400 ms
	Offset-2 Sweep Time	40 ms
	Offset-3 Sweep Time	40 ms
	Offset-1 Auto Sweep Time Select	Normal
	Offset-2 Auto Sweep Time Select	Normal
	Offset-3 Auto Sweep Time Select	Normal
	Offset-1 Detection	RMS
	Offset-2 Detection	RMS
	Offset-3 Detection	RMS
	Offset-1 Trace Point	401
	Offset-2 Trace Point	41
	Offset-3 Trace Point	41
	Offset-1 Integrate BW	Auto
Offset-2 Integrate BW	Auto	
Offset-3 Integrate BW	Auto	

Table C-5 Standard parameters for Spectrum Emission Mask (Cont'd)

Standard	Parameter Name	Setting
LTE Uplink (General 10MHz)	Offset-1 On/Off	On
	Offset-2 On/Off	On
	Offset-3 On/Off	On
	Offset-4 On/Off	Off
	Offset-5 On/Off	Off
	Offset-6 On/Off	Off
LTE TDD Uplink (General 10MHz) (Cont'd)	Limit-1 ABS1 Start Level	-16.5 dBm
	Limit-2 ABS1 Start Level	-8.5 dBm
	Limit-3 ABS1 Start Level	-11.5 dBm
	Limit-1 ABS1 Stop Level	-16.5 dBm
	Limit-2 ABS1 Stop Level	-8.5 dBm
	Limit-3 ABS1 Stop Level	-11.5 dBm
	Limit-1 Fail Logic	ABS1
	Limit-2 Fail Logic	ABS1
	Limit-3 Fail Logic	ABS1
	Limit-4 Fail Logic	Off
Limit-5 Fail Logic	Off	
Limit-6 Fail Logic	Off	

Table C-5 Standard parameters for Spectrum Emission Mask (Cont'd)

Standard	Parameter Name	Setting	
LTE Uplink (General 15MHz)	Limit Side	Both	
	Noise Cancel	Off	
	Reference Mode	Channel	
	Channel BW	15 MHz	
	RBW	300 kHz	
	Sweep Time	500 ms	
	Auto Sweep Time Select	Normal	
	Detection	RMS	
	Trace Point	501	
	Filter Type	Rect	
	Offset-1 Start Freq	7.515 MHz	
	Offset-2 Start Freq	9 MHz	
	Offset-3 Start Freq	13 MHz	
	Offset-1 Stop Freq	8.485 MHz	
	Offset-2 Stop Freq	12 MHz	
	Offset-3 Stop Freq	22 MHz	
	Offset-1/2/3 Reference Level	Auto	
	Offset-1 RBW	30 kHz	
	Offset-2 RBW	1 MHz	
	Offset-3 RBW	1 MHz	
	LTE TDD Uplink (General 15MHz)	Offset-1 Sweep Time	400 ms
		Offset-2 Sweep Time	40 ms
		Offset-3 Sweep Time	100 ms
		Offset-1 Auto Sweep Time Select	Normal
		Offset-2 Auto Sweep Time Select	Normal
		Offset-3 Auto Sweep Time Select	Normal
		Offset-1 Detection	RMS
		Offset-2 Detection	RMS
		Offset-3 Detection	RMS
		Offset-1 Trace Point	401
		Offset-2 Trace Point	41
		Offset-3 Trace Point	101
		Offset-1 Integrate BW	Auto
	Offset-2 Integrate BW	Auto	
	Offset-3 Integrate BW	Auto	

Table C-5 Standard parameters for Spectrum Emission Mask (Cont'd)

Standard	Parameter Name	Setting
LTE Uplink (General 15MHz)	Offset-1 On/Off	On
	Offset-2 On/Off	On
	Offset-3 On/Off	On
	Offset-4 On/Off	Off
	Offset-5 On/Off	Off
	Offset-6 On/Off	Off
LTE TDD Uplink (General 15MHz) (Cont'd)	Limit-1 ABS1 Start Level	-18.5 dBm
	Limit-2 ABS1 Start Level	-8.5 dBm
	Limit-3 ABS1 Start Level	-11.5 dBm
	Limit-1 ABS1 Stop Level	-18.5 dBm
	Limit-2 ABS1 Stop Level	-8.5 dBm
	Limit-3 ABS1 Stop Level	-11.5 dBm
	Limit-1 Fail Logic	ABS1
	Limit-2 Fail Logic	ABS1
	Limit-3 Fail Logic	ABS1
	Limit-4 Fail Logic	Off
Limit-5 Fail Logic	Off	
Limit-6 Fail Logic	Off	

Table C-5 Standard parameters for Spectrum Emission Mask (Cont'd)

Standard	Parameter Name	Setting
LTE Uplink (General 20MHz) LTE TDD Uplink (General 20MHz)	Limit Side	Both
	Noise Cancel	Off
	Reference Mode	Channel
	Channel BW	20 MHz
	RBW	300 kHz
	Sweep Time	1000 ms
	Auto Sweep Time Select	Normal
	Detection	RMS
	Trace Point	1001
	Filter Type	Rect
	Offset-1 Start Freq	10.015 MHz
	Offset-2 Start Freq	11.5 MHz
	Offset-3 Start Freq	15.5 MHz
	Offset-1 Stop Freq	10.985 MHz
	Offset-2 Stop Freq	14.5 MHz
	Offset-3 Stop Freq	29.5 MHz
	Offset-1/2/3 Reference Level	Auto
	Offset-1 RBW	30 kHz
	Offset-2 RBW	1 MHz
	Offset-3 RBW	1 MHz
	Offset-1 Sweep Time	400 ms
	Offset-2 Sweep Time	40 ms
	Offset-3 Sweep Time	200 ms
	Offset-1 Auto Sweep Time Select	Normal
	Offset-2 Auto Sweep Time Select	Normal
	Offset-3 Auto Sweep Time Select	Normal
	Offset-1 Detection	RMS
	Offset-2 Detection	RMS
	Offset-3 Detection	RMS
	Offset-1 Trace Point	401
	Offset-2 Trace Point	41
	Offset-3 Trace Point	201
	Offset-1 Integrate BW	Auto
Offset-2 Integrate BW	Auto	
Offset-3 Integrate BW	Auto	

Table C-5 Standard parameters for Spectrum Emission Mask (Cont'd)

Standard	Parameter Name	Setting
LTE Uplink (General 20MHz)	Offset-1 On/Off	On
	Offset-2 On/Off	On
	Offset-3 On/Off	On
	Offset-4 On/Off	Off
	Offset-5 On/Off	Off
	Offset-6 On/Off	Off
LTE TDD Uplink (General 20MHz) (Cont'd)	Limit-1 ABS1 Start Level	-19.5 dBm
	Limit-2 ABS1 Start Level	-8.5 dBm
	Limit-3 ABS1 Start Level	-11.5 dBm
	Limit-1 ABS1 Stop Level	-19.5 dBm
	Limit-2 ABS1 Stop Level	-8.5 dBm
	Limit-3 ABS1 Stop Level	-11.5 dBm
	Limit-1 Fail Logic	ABS1
	Limit-2 Fail Logic	ABS1
	Limit-3 Fail Logic	ABS1
	Limit-4 Fail Logic	Off
Limit-5 Fail Logic	Off	
Limit-6 Fail Logic	Off	

Table C-5 Standard parameters for Spectrum Emission Mask (Cont'd)

Standard	Parameter Name	Setting
LTE Uplink (NS-03 1.4MHz) LTE TDD Uplink (NS-03 1.4MHz)	Limit Side	Both
	Noise Cancel	Off
	Reference Mode	Channel
	Channel BW	1.4 MHz
	RBW	30 kHz
	Sweep Time	500 ms
	Auto Sweep Time Select	Normal
	Detection	RMS
	Trace Point	501
	Filter Type	Rect
	Offset-1 Start Freq	0.715 MHz
	Offset-2 Start Freq	2.2 MHz
	Offset-3 Start Freq	3.7 MHz
	Offset-1 Stop Freq	1.685 MHz
	Offset-2 Stop Freq	2.7 MHz
	Offset-3 Stop Freq	5.2 MHz
	Offset-1/2/3 Reference Level	Auto
	Offset-1 RBW	30 kHz
	Offset-2 RBW	1 MHz
	Offset-3 RBW	1 MHz
	Offset-1 Sweep Time	400 ms
	Offset-2 Sweep Time	10 ms
	Offset-3 Sweep Time	20 ms
	Offset-1 Auto Sweep Time Select	Normal
	Offset-2 Auto Sweep Time Select	Normal
	Offset-3 Auto Sweep Time Select	Normal
	Offset-1 Detection	RMS
	Offset-2 Detection	RMS
	Offset-3 Detection	RMS
	Offset-1 Trace Point	401
	Offset-2 Trace Point	11
	Offset-3 Trace Point	21
	Offset-1 Integrate BW	Auto
Offset-2 Integrate BW	Auto	
Offset-3 Integrate BW	Auto	

Table C-5 Standard parameters for Spectrum Emission Mask (Cont'd)

Standard	Parameter Name	Setting
LTE Uplink (NS-03 1.4MHz)	Offset-1 On/Off	On
	Offset-2 On/Off	On
	Offset-3 On/Off	On
	Offset-4 On/Off	Off
	Offset-5 On/Off	Off
	Offset-6 On/Off	Off
LTE TDD Uplink (NS-03 1.4MHz) (Cont'd)	Limit-1 ABS1 Start Level	-8.5 dBm
	Limit-2 ABS1 Start Level	-11.5 dBm
	Limit-3 ABS1 Start Level	-23.5 dBm
	Limit-1 ABS1 Stop Level	-8.5 dBm
	Limit-2 ABS1 Stop Level	-11.5 dBm
	Limit-3 ABS1 Stop Level	-23.5 dBm
	Limit-1 Fail Logic	ABS1
	Limit-2 Fail Logic	ABS1
	Limit-3 Fail Logic	ABS1
	Limit-4 Fail Logic	Off
Limit-5 Fail Logic	Off	
Limit-6 Fail Logic	Off	

Table C-5 Standard parameters for Spectrum Emission Mask (Cont'd)

Standard	Parameter Name	Setting	
LTE Uplink (NS-03 3MHz)	Limit Side	Both	
	Noise Cancel	Off	
	Reference Mode	Channel	
	Channel BW	3 MHz	
	RBW	30 kHz	
	Sweep Time	1000 ms	
	Auto Sweep Time Select	Normal	
	Detection	RMS	
	Trace Point	1001	
	Filter Type	Rect	
	Offset-1 Start Freq	1.515 MHz	
	Offset-2 Start Freq	3 MHz	
	Offset-3 Start Freq	6.699700 MHz	
	Offset-1 Stop Freq	2.485 MHz	
	Offset-2 Stop Freq	6 MHz	
	Offset-3 Stop Freq	7 MHz	
	Offset-1/2/3 Reference Level	Auto	
	Offset-1 RBW	30 kHz	
	Offset-2 RBW	1 MHz	
	Offset-3 RBW	1 MHz	
	LTE TDD Uplink (NS-03 3MHz)	Offset-1 Sweep Time	100 ms
		Offset-2 Sweep Time	40 ms
		Offset-3 Sweep Time	10 ms
		Offset-1 Auto Sweep Time Select	Normal
		Offset-2 Auto Sweep Time Select	Normal
		Offset-3 Auto Sweep Time Select	Normal
		Offset-1 Detection	RMS
		Offset-2 Detection	RMS
		Offset-3 Detection	RMS
		Offset-1 Trace Point	101
		Offset-2 Trace Point	41
		Offset-3 Trace Point	11
		Offset-1 Integrate BW	Auto
	Offset-2 Integrate BW	Auto	
	Offset-3 Integrate BW	Auto	

Table C-5 Standard parameters for Spectrum Emission Mask (Cont'd)

Standard	Parameter Name	Setting
LTE Uplink (NS-03 3MHz)	Offset-1 On/Off	On
	Offset-2 On/Off	On
	Offset-3 On/Off	On
	Offset-4 On/Off	Off
	Offset-5 On/Off	Off
	Offset-6 On/Off	Off
LTE TDD Uplink (NS-03 3MHz) (Cont'd)	Limit-1 ABS1 Start Level	-11.5 dBm
	Limit-2 ABS1 Start Level	-11.5 dBm
	Limit-3 ABS1 Start Level	-23.5 dBm
	Limit-1 ABS1 Stop Level	-11.5 dBm
	Limit-2 ABS1 Stop Level	-11.5 dBm
	Limit-3 ABS1 Stop Level	-23.5 dBm
	Limit-1 Fail Logic	ABS1
	Limit-2 Fail Logic	ABS1
	Limit-3 Fail Logic	ABS1
	Limit-4 Fail Logic	Off
Limit-5 Fail Logic	Off	
Limit-6 Fail Logic	Off	

Table C-5 Standard parameters for Spectrum Emission Mask (Cont'd)

Standard	Parameter Name	Setting	
LTE Uplink (NS-03 5MHz)	Limit Side	Both	
	Noise Cancel	Off	
	Reference Mode	Channel	
	Channel BW	5 MHz	
	RBW	100 kHz	
	Sweep Time	500 ms	
	Auto Sweep Time Select	Normal	
	Detection	RMS	
	Trace Point	501	
	Filter Type	Rect	
	Offset-1 Start Freq	2.515 MHz	
	Offset-2 Start Freq	4 MHz	
	Offset-3 Start Freq	7.9997 MHz	
	Offset-1 Stop Freq	3.485 MHz	
	Offset-2 Stop Freq	7 MHz	
	Offset-3 Stop Freq	8 MHz	
	Offset-1/2/3 Reference Level	Auto	
	Offset-1 RBW	30 kHz	
	Offset-2 RBW	1 MHz	
	Offset-3 RBW	1 MHz	
	LTE TDD Uplink (NS-03 5MHz)	Offset-1 Sweep Time	400 ms
		Offset-2 Sweep Time	40 ms
		Offset-3 Sweep Time	10 ms
		Offset-1 Auto Sweep Time Select	Normal
		Offset-2 Auto Sweep Time Select	Normal
		Offset-3 Auto Sweep Time Select	Normal
		Offset-1 Detection	RMS
		Offset-2 Detection	RMS
		Offset-3 Detection	RMS
		Offset-1 Trace Point	401
		Offset-2 Trace Point	41
		Offset-3 Trace Point	11
		Offset-1 Integrate BW	Auto
	Offset-2 Integrate BW	Auto	
	Offset-3 Integrate BW	Auto	

Table C-5 Standard parameters for Spectrum Emission Mask (Cont'd)

Standard	Parameter Name	Setting
LTE Uplink (NS-03 5MHz)	Offset-1 On/Off	On
	Offset-2 On/Off	On
	Offset-3 On/Off	On
	Offset-4 On/Off	Off
	Offset-5 On/Off	Off
	Offset-6 On/Off	Off
LTE TDD Uplink (NS-03 5MHz) (Cont'd)	Limit-1 ABS1 Start Level	-11.5 dBm
	Limit-2 ABS1 Start Level	-11.5 dBm
	Limit-3 ABS1 Start Level	-23.5 dBm
	Limit-1 ABS1 Stop Level	-11.5 dBm
	Limit-2 ABS1 Stop Level	-11.5 dBm
	Limit-3 ABS1 Stop Level	-23.5 dBm
	Limit-1 Fail Logic	ABS1
	Limit-2 Fail Logic	ABS1
	Limit-3 Fail Logic	ABS1
	Limit-4 Fail Logic	Off
Limit-5 Fail Logic	Off	
Limit-6 Fail Logic	Off	

Table C-5 Standard parameters for Spectrum Emission Mask (Cont'd)

Standard	Parameter Name	Setting
LTE Uplink (NS-03 10MHz) LTE TDD Uplink (NS-03 10MHz)	Limit Side	Both
	Noise Cancel	Off
	Reference Mode	Channel
	Channel BW	10 MHz
	RBW	300 kHz
	Sweep Time	400 ms
	Auto Sweep Time Select	Normal
	Detection	RMS
	Trace Point	401
	Filter Type	Rect
	Offset-1 Start Freq	5.015 MHz
	Offset-2 Start Freq	6.5 MHz
	Offset-3 Start Freq	15.5 MHz
	Offset-1 Stop Freq	5.985 MHz
	Offset-2 Stop Freq	14.5 MHz
	Offset-3 Stop Freq	19.5 MHz
	Offset-1/2/3 Reference Level	Auto
	Offset-1 RBW	30 kHz
	Offset-2 RBW	1 MHz
	Offset-3 RBW	1 MHz
	Offset-1 Sweep Time	400 ms
	Offset-2 Sweep Time	100 ms
	Offset-3 Sweep Time	40 ms
	Offset-1 Auto Sweep Time Select	Normal
	Offset-2 Auto Sweep Time Select	Normal
	Offset-3 Auto Sweep Time Select	Normal
	Offset-1 Detection	RMS
	Offset-2 Detection	RMS
	Offset-3 Detection	RMS
	Offset-1 Trace Point	401
	Offset-2 Trace Point	101
	Offset-3 Trace Point	41
	Offset-1 Integrate BW	Auto
Offset-2 Integrate BW	Auto	
Offset-3 Integrate BW	Auto	

Table C-5 Standard parameters for Spectrum Emission Mask (Cont'd)

Standard	Parameter Name	Setting
LTE Uplink (NS-03 10MHz)	Offset-1 On/Off	On
	Offset-2 On/Off	On
	Offset-3 On/Off	On
	Offset-4 On/Off	Off
	Offset-5 On/Off	Off
	Offset-6 On/Off	Off
LTE TDD Uplink (NS-03 10MHz) (Cont'd)	Limit-1 ABS1 Start Level	-16.5 dBm
	Limit-2 ABS1 Start Level	-11.5 dBm
	Limit-3 ABS1 Start Level	-23.5 dBm
	Limit-1 ABS1 Stop Level	-16.5 dBm
	Limit-2 ABS1 Stop Level	-11.5 dBm
	Limit-3 ABS1 Stop Level	-23.5 dBm
	Limit-1 Fail Logic	ABS1
	Limit-2 Fail Logic	ABS1
	Limit-3 Fail Logic	ABS1
	Limit-4 Fail Logic	Off
Limit-5 Fail Logic	Off	
Limit-6 Fail Logic	Off	

Table C-5 Standard parameters for Spectrum Emission Mask (Cont'd)

Standard	Parameter Name	Setting
LTE Uplink (NS-03 15MHz) LTE TDD Uplink (NS-03 15MHz)	Limit Side	Both
	Noise Cancel	Off
	Reference Mode	Channel
	Channel BW	15 MHz
	RBW	300 kHz
	Sweep Time	500 ms
	Auto Sweep Time Select	Normal
	Detection	RMS
	Trace Point	501
	Filter Type	Rect
	Offset-1 Start Freq	7.515 MHz
	Offset-2 Start Freq	9 MHz
	Offset-3 Start Freq	23 MHz
	Offset-1 Stop Freq	8.485 MHz
	Offset-2 Stop Freq	22 MHz
	Offset-3 Stop Freq	27 MHz
	Offset-1/2/3 Reference Level	Auto
	Offset-1 RBW	30 kHz
	Offset-2 RBW	1 MHz
	Offset-3 RBW	1 MHz
	Offset-1 Sweep Time	400 ms
	Offset-2 Sweep Time	200 ms
	Offset-3 Sweep Time	40 ms
	Offset-1 Auto Sweep Time Select	Normal
	Offset-2 Auto Sweep Time Select	Normal
	Offset-3 Auto Sweep Time Select	Normal
	Offset-1 Detection	RMS
	Offset-2 Detection	RMS
	Offset-3 Detection	RMS
	Offset-1 Trace Point	401
	Offset-2 Trace Point	201
	Offset-3 Trace Point	41
	Offset-1 Integrate BW	Auto
Offset-2 Integrate BW	Auto	
Offset-3 Integrate BW	Auto	

Table C-5 Standard parameters for Spectrum Emission Mask (Cont'd)

Standard	Parameter Name	Setting
LTE Uplink (NS-03 15MHz)	Offset-1 On/Off	On
	Offset-2 On/Off	On
	Offset-3 On/Off	On
	Offset-4 On/Off	Off
	Offset-5 On/Off	Off
	Offset-6 On/Off	Off
LTE TDD Uplink (NS-03 15MHz) (Cont'd)	Limit-1 ABS1 Start Level	-18.5 dBm
	Limit-2 ABS1 Start Level	-11.5 dBm
	Limit-3 ABS1 Start Level	-23.5 dBm
	Limit-1 ABS1 Stop Level	-18.5 dBm
	Limit-2 ABS1 Stop Level	-11.5 dBm
	Limit-3 ABS1 Stop Level	-23.5 dBm
	Limit-1 Fail Logic	ABS1
	Limit-2 Fail Logic	ABS1
	Limit-3 Fail Logic	ABS1
	Limit-4 Fail Logic	Off
Limit-5 Fail Logic	Off	
Limit-6 Fail Logic	Off	

Table C-5 Standard parameters for Spectrum Emission Mask (Cont'd)

Standard	Parameter Name	Setting
LTE Uplink (NS-03 20MHz)	Limit Side	Both
	Noise Cancel	Off
	Reference Mode	Channel
	Channel BW	20 MHz
	RBW	300 kHz
	Sweep Time	1000 ms
	Auto Sweep Time Select	Normal
	Detection	RMS
	Trace Point	1001
	Filter Type	Rect
	Offset-1 Start Freq	10.015 MHz
	Offset-2 Start Freq	11.5 MHz
	Offset-3 Start Freq	30.5 MHz
	Offset-1 Stop Freq	10.985 MHz
	Offset-2 Stop Freq	29.5 MHz
	Offset-3 Stop Freq	34.5 MHz
	Offset-1/2/3 Reference Level	Auto
	Offset-1 RBW	30 kHz
	Offset-2 RBW	1 MHz
	Offset-3 RBW	1 MHz
	Offset-1 Sweep Time	400 ms
	Offset-2 Sweep Time	200 ms
	Offset-3 Sweep Time	40 ms
	Offset-1 Auto Sweep Time Select	Normal
	Offset-2 Auto Sweep Time Select	Normal
	Offset-3 Auto Sweep Time Select	Normal
	Offset-1 Detection	RMS
	Offset-2 Detection	RMS
	Offset-3 Detection	RMS
	Offset-1 Trace Point	401
	Offset-2 Trace Point	201
	Offset-3 Trace Point	41
	Offset-1 Integrate BW	Auto
Offset-2 Integrate BW	Auto	
Offset-3 Integrate BW	Auto	
LTE TDD Uplink (NS-03 20MHz)		

Table C-5 Standard parameters for Spectrum Emission Mask (Cont'd)

Standard	Parameter Name	Setting
LTE Uplink (NS-03 20MHz)	Offset-1 On/Off	On
	Offset-2 On/Off	On
	Offset-3 On/Off	On
	Offset-4 On/Off	Off
	Offset-5 On/Off	Off
	Offset-6 On/Off	Off
LTE TDD Uplink (NS-03 20MHz) (Cont'd)	Limit-1 ABS1 Start Level	-19.5 dBm
	Limit-2 ABS1 Start Level	-11.5 dBm
	Limit-3 ABS1 Start Level	-23.5 dBm
	Limit-1 ABS1 Stop Level	-19.5 dBm
	Limit-2 ABS1 Stop Level	-11.5 dBm
	Limit-3 ABS1 Stop Level	-23.5 dBm
	Limit-1 Fail Logic	ABS1
	Limit-2 Fail Logic	ABS1
	Limit-3 Fail Logic	ABS1
	Limit-4 Fail Logic	Off
Limit-5 Fail Logic	Off	
Limit-6 Fail Logic	Off	

Table C-5 Standard parameters for Spectrum Emission Mask (Cont'd)

Standard	Parameter Name	Setting
LTE Uplink (NS-04 1.4MHz) LTE TDD Uplink (NS-04 1.4MHz)	Limit Side	Both
	Noise Cancel	Off
	Reference Mode	Channel
	Channel BW	1.4 MHz
	RBW	30 kHz
	Sweep Time	500 ms
	Auto Sweep Time Select	Normal
	Detection	RMS
	Trace Point	501
	Filter Type	Rect
	Offset-1 Start Freq	0.715 MHz
	Offset-2 Start Freq	2.2 MHz
	Offset-3 Start Freq	3.7 MHz
	Offset-1 Stop Freq	1.685 MHz
	Offset-2 Stop Freq	2.7 MHz
	Offset-3 Stop Freq	5.2 MHz
	Offset-1/2/3 Reference Level	Auto
	Offset-1 RBW	30 kHz
	Offset-2 RBW	1 MHz
	Offset-3 RBW	1 MHz
	Offset-1 Sweep Time	400 ms
	Offset-2 Sweep Time	10 ms
	Offset-3 Sweep Time	20 ms
	Offset-1 Auto Sweep Time Select	Normal
	Offset-2 Auto Sweep Time Select	Normal
	Offset-3 Auto Sweep Time Select	Normal
	Offset-1 Detection	RMS
	Offset-2 Detection	RMS
	Offset-3 Detection	RMS
	Offset-1 Trace Point	401
	Offset-2 Trace Point	11
	Offset-3 Trace Point	21
	Offset-1 Integrate BW	Auto
Offset-2 Integrate BW	Auto	
Offset-3 Integrate BW	Auto	

Table C-5 Standard parameters for Spectrum Emission Mask (Cont'd)

Standard	Parameter Name	Setting
LTE Uplink (NS-04 1.4MHz)	Offset-1 On/Off	On
	Offset-2 On/Off	On
	Offset-3 On/Off	On
	Offset-4 On/Off	Off
	Offset-5 On/Off	Off
	Offset-6 On/Off	Off
LTE TDD Uplink (NS-04 1.4MHz) (Cont'd)	Limit-1 ABS1 Start Level	-8.5 dBm
	Limit-2 ABS1 Start Level	-11.5 dBm
	Limit-3 ABS1 Start Level	-23.5 dBm
	Limit-1 ABS1 Stop Level	-8.5 dBm
	Limit-2 ABS1 Stop Level	-11.5 dBm
	Limit-3 ABS1 Stop Level	-23.5 dBm
	Limit-1 Fail Logic	ABS1
	Limit-2 Fail Logic	ABS1
	Limit-3 Fail Logic	ABS1
	Limit-4 Fail Logic	Off
Limit-5 Fail Logic	Off	
Limit-6 Fail Logic	Off	

Table C-5 Standard parameters for Spectrum Emission Mask (Cont'd)

Standard	Parameter Name	Setting	
LTE Uplink (NS-04 3MHz)	Limit Side	Both	
	Noise Cancel	Off	
	Reference Mode	Channel	
	Channel BW	3 MHz	
	RBW	30 kHz	
	Sweep Time	1000 ms	
	Auto Sweep Time Select	Normal	
	Detection	RMS	
	Trace Point	1001	
	Filter Type	Rect	
	Offset-1 Start Freq	1.515 MHz	
	Offset-2 Start Freq	3 MHz	
	Offset-3 Start Freq	6.699700 MHz	
	Offset-1 Stop Freq	2.485 MHz	
	Offset-2 Stop Freq	6 MHz	
	Offset-3 Stop Freq	7 MHz	
	Offset-1/2/3 Reference Level	Auto	
	Offset-1 RBW	30 kHz	
	Offset-2 RBW	1 MHz	
	Offset-3 RBW	1 MHz	
	LTE TDD Uplink (NS-04 3MHz)	Offset-1 Sweep Time	400 ms
		Offset-2 Sweep Time	40 ms
		Offset-3 Sweep Time	10 ms
		Offset-1 Auto Sweep Time Select	Normal
		Offset-2 Auto Sweep Time Select	Normal
		Offset-3 Auto Sweep Time Select	Normal
		Offset-1 Detection	RMS
		Offset-2 Detection	RMS
		Offset-3 Detection	RMS
		Offset-1 Trace Point	401
		Offset-2 Trace Point	41
		Offset-3 Trace Point	11
		Offset-1 Integrate BW	Auto
	Offset-2 Integrate BW	Auto	
	Offset-3 Integrate BW	Auto	

Table C-5 Standard parameters for Spectrum Emission Mask (Cont'd)

Standard	Parameter Name	Setting
LTE Uplink (NS-04 3MHz)	Offset-1 On/Off	On
	Offset-2 On/Off	On
	Offset-3 On/Off	On
	Offset-4 On/Off	Off
	Offset-5 On/Off	Off
	Offset-6 On/Off	Off
LTE TDD Uplink (NS-04 3MHz) (Cont'd)	Limit-1 ABS1 Start Level	-11.5 dBm
	Limit-2 ABS1 Start Level	-11.5 dBm
	Limit-3 ABS1 Start Level	-23.5 dBm
	Limit-1 ABS1 Stop Level	-11.5 dBm
	Limit-2 ABS1 Stop Level	-11.5 dBm
	Limit-3 ABS1 Stop Level	-23.5 dBm
	Limit-1 Fail Logic	ABS1
	Limit-2 Fail Logic	ABS1
	Limit-3 Fail Logic	ABS1
	Limit-4 Fail Logic	Off
Limit-5 Fail Logic	Off	
Limit-6 Fail Logic	Off	

Table C-5 Standard parameters for Spectrum Emission Mask (Cont'd)

Standard	Parameter Name	Setting	
LTE Uplink (NS-04 5MHz)	Limit Side	Both	
	Noise Cancel	Off	
	Reference Mode	Channel	
	Channel BW	5 MHz	
	RBW	100 kHz	
	Sweep Time	500 ms	
	Auto Sweep Time Select	Normal	
	Detection	RMS	
	Trace Point	501	
	Filter Type	Rect	
	Offset-1 Start Freq	2.515 MHz	
	Offset-2 Start Freq	4 MHz	
	Offset-3 Start Freq	8 MHz	
	Offset-1 Stop Freq	3.485 MHz	
	Offset-2 Stop Freq	7 MHz	
	Offset-3 Stop Freq	12 MHz	
	Offset-1/2/3 Reference Level	Auto	
	Offset-1 RBW	30 kHz	
	Offset-2 RBW	1 MHz	
	Offset-3 RBW	1 MHz	
	LTE TDD Uplink (NS-04 5MHz)	Offset-1 Sweep Time	400 ms
		Offset-2 Sweep Time	40 ms
		Offset-3 Sweep Time	40 ms
		Offset-1 Auto Sweep Time Select	Normal
		Offset-2 Auto Sweep Time Select	Normal
		Offset-3 Auto Sweep Time Select	Normal
		Offset-1 Detection	RMS
		Offset-2 Detection	RMS
		Offset-3 Detection	RMS
		Offset-1 Trace Point	401
		Offset-2 Trace Point	41
		Offset-3 Trace Point	41
		Offset-1 Integrate BW	Auto
	Offset-2 Integrate BW	Auto	
	Offset-3 Integrate BW	Auto	

Table C-5 Standard parameters for Spectrum Emission Mask (Cont'd)

Standard	Parameter Name	Setting
LTE Uplink (NS-04 5MHz)	Offset-1 On/Off	On
	Offset-2 On/Off	On
	Offset-3 On/Off	On
	Offset-4 On/Off	Off
	Offset-5 On/Off	Off
	Offset-6 On/Off	Off
LTE TDD Uplink (NS-04 5MHz) (Cont'd)	Limit-1 ABS1 Start Level	-13.5 dBm
	Limit-2 ABS1 Start Level	-11.5 dBm
	Limit-3 ABS1 Start Level	-23.5 dBm
	Limit-1 ABS1 Stop Level	-13.5 dBm
	Limit-2 ABS1 Stop Level	-11.5 dBm
	Limit-3 ABS1 Stop Level	-23.5 dBm
	Limit-1 Fail Logic	ABS1
	Limit-2 Fail Logic	ABS1
	Limit-3 Fail Logic	ABS1
	Limit-4 Fail Logic	Off
Limit-5 Fail Logic	Off	
Limit-6 Fail Logic	Off	

Table C-5 Standard parameters for Spectrum Emission Mask (Cont'd)

Standard	Parameter Name	Setting	
LTE Uplink (NS-04 10MHz)	Limit Side	Both	
	Noise Cancel	Off	
	Reference Mode	Channel	
	Channel BW	10 MHz	
	RBW	300 kHz	
	Sweep Time	400 ms	
	Auto Sweep Time Select	Normal	
	Detection	RMS	
	Trace Point	401	
	Filter Type	Rect	
	Offset-1 Start Freq	5.015 MHz	
	Offset-2 Start Freq	6.5 MHz	
	Offset-3 Start Freq	10.5 MHz	
	Offset-1 Stop Freq	5.985 MHz	
	Offset-2 Stop Freq	9.5 MHz	
	Offset-3 Stop Freq	19.5 MHz	
	Offset-1/2/3 Reference Level	Auto	
	Offset-1 RBW	30 kHz	
	Offset-2 RBW	1 MHz	
	Offset-3 RBW	1 MHz	
	LTE TDD Uplink (NS-04 10MHz)	Offset-1 Sweep Time	400 ms
		Offset-2 Sweep Time	100 ms
		Offset-3 Sweep Time	40 ms
		Offset-1 Auto Sweep Time Select	Normal
		Offset-2 Auto Sweep Time Select	Normal
		Offset-3 Auto Sweep Time Select	Normal
		Offset-1 Detection	RMS
		Offset-2 Detection	RMS
		Offset-3 Detection	RMS
		Offset-1 Trace Point	401
		Offset-2 Trace Point	101
		Offset-3 Trace Point	41
		Offset-1 Integrate BW	Auto
	Offset-2 Integrate BW	Auto	
	Offset-3 Integrate BW	Auto	

Table C-5 Standard parameters for Spectrum Emission Mask (Cont'd)

Standard	Parameter Name	Setting
LTE Uplink (NS-04 10MHz)	Offset-1 On/Off	On
	Offset-2 On/Off	On
	Offset-3 On/Off	On
	Offset-4 On/Off	Off
	Offset-5 On/Off	Off
	Offset-6 On/Off	Off
LTE TDD Uplink (NS-04 10MHz) (Cont'd)	Limit-1 ABS1 Start Level	-16.5 dBm
	Limit-2 ABS1 Start Level	-11.5 dBm
	Limit-3 ABS1 Start Level	-23.5 dBm
	Limit-1 ABS1 Stop Level	-16.5 dBm
	Limit-2 ABS1 Stop Level	-11.5 dBm
	Limit-3 ABS1 Stop Level	-23.5 dBm
	Limit-1 Fail Logic	ABS1
	Limit-2 Fail Logic	ABS1
	Limit-3 Fail Logic	ABS1
	Limit-4 Fail Logic	Off
	Limit-5 Fail Logic	Off
	Limit-6 Fail Logic	Off

Table C-5 Standard parameters for Spectrum Emission Mask (Cont'd)

Standard	Parameter Name	Setting	
LTE Uplink (NS-04 15MHz)	Limit Side	Both	
	Noise Cancel	Off	
	Reference Mode	Channel	
	Channel BW	15 MHz	
	RBW	300 kHz	
	Sweep Time	500 ms	
	Auto Sweep Time Select	Normal	
	Detection	RMS	
	Trace Point	501	
	Filter Type	Rect	
	Offset-1 Start Freq	7.515 MHz	
	Offset-2 Start Freq	9 MHz	
	Offset-3 Start Freq	13 MHz	
	Offset-1 Stop Freq	8.485 MHz	
	Offset-2 Stop Freq	12 MHz	
	Offset-3 Stop Freq	27 MHz	
	Offset-1/2/3 Reference Level	Auto	
	Offset-1 RBW	30 kHz	
	Offset-2 RBW	1 MHz	
	Offset-3 RBW	1 MHz	
	LTE TDD Uplink (NS-04 15MHz)	Offset-1 Sweep Time	400 ms
		Offset-2 Sweep Time	200 ms
		Offset-3 Sweep Time	40 ms
		Offset-1 Auto Sweep Time Select	Normal
		Offset-2 Auto Sweep Time Select	Normal
		Offset-3 Auto Sweep Time Select	Normal
		Offset-1 Detection	RMS
		Offset-2 Detection	RMS
		Offset-3 Detection	RMS
		Offset-1 Trace Point	401
		Offset-2 Trace Point	201
		Offset-3 Trace Point	41
		Offset-1 Integrate BW	Auto
	Offset-2 Integrate BW	Auto	
	Offset-3 Integrate BW	Auto	

Table C-5 Standard parameters for Spectrum Emission Mask (Cont'd)

Standard	Parameter Name	Setting
LTE Uplink (NS-04 15MHz)	Offset-1 On/Off	On
	Offset-2 On/Off	On
	Offset-3 On/Off	On
	Offset-4 On/Off	Off
	Offset-5 On/Off	Off
	Offset-6 On/Off	Off
LTE TDD Uplink (NS-04 15MHz) (Cont'd)	Limit-1 ABS1 Start Level	-18.5 dBm
	Limit-2 ABS1 Start Level	-11.5 dBm
	Limit-3 ABS1 Start Level	-23.5 dBm
	Limit-1 ABS1 Stop Level	-18.5 dBm
	Limit-2 ABS1 Stop Level	-11.5 dBm
	Limit-3 ABS1 Stop Level	-23.5 dBm
	Limit-1 Fail Logic	ABS1
	Limit-2 Fail Logic	ABS1
	Limit-3 Fail Logic	ABS1
	Limit-4 Fail Logic	Off
Limit-5 Fail Logic	Off	
Limit-6 Fail Logic	Off	

Table C-5 Standard parameters for Spectrum Emission Mask (Cont'd)

Standard	Parameter Name	Setting
LTE Uplink (NS-04 20MHz)	Limit Side	Both
	Noise Cancel	Off
	Reference Mode	Channel
	Channel BW	20 MHz
	RBW	300 kHz
	Sweep Time	1000 ms
	Auto Sweep Time Select	Normal
	Detection	RMS
	Trace Point	1001
	Filter Type	Rect
	Offset-1 Start Freq	10.015 MHz
	Offset-2 Start Freq	11.5 MHz
	Offset-3 Start Freq	15.5 MHz
	Offset-1 Stop Freq	10.985 MHz
	Offset-2 Stop Freq	14.5 MHz
	Offset-3 Stop Freq	34.5 MHz
	Offset-1/2/3 Reference Level	Auto
	Offset-1 RBW	30 kHz
	Offset-2 RBW	1 MHz
	Offset-3 RBW	1 MHz
	Offset-1 Sweep Time	400 ms
	Offset-2 Sweep Time	200 ms
	Offset-3 Sweep Time	40 ms
	Offset-1 Auto Sweep Time Select	Normal
	Offset-2 Auto Sweep Time Select	Normal
	Offset-3 Auto Sweep Time Select	Normal
	Offset-1 Detection	RMS
	Offset-2 Detection	RMS
	Offset-3 Detection	RMS
	Offset-1 Trace Point	401
	Offset-2 Trace Point	201
	Offset-3 Trace Point	41
	Offset-1 Integrate BW	Auto
Offset-2 Integrate BW	Auto	
Offset-3 Integrate BW	Auto	
LTE TDD Uplink (NS-04 20MHz)		

Table C-5 Standard parameters for Spectrum Emission Mask (Cont'd)

Standard	Parameter Name	Setting
LTE Uplink (NS-04 20MHz)	Offset-1 On/Off	On
	Offset-2 On/Off	On
	Offset-3 On/Off	On
	Offset-4 On/Off	Off
	Offset-5 On/Off	Off
	Offset-6 On/Off	Off
LTE TDD Uplink (NS-04 20MHz) (Cont'd)	Limit-1 ABS1 Start Level	-19.5 dBm
	Limit-2 ABS1 Start Level	-11.5 dBm
	Limit-3 ABS1 Start Level	-23.5 dBm
	Limit-1 ABS1 Stop Level	-19.5 dBm
	Limit-2 ABS1 Stop Level	-11.5 dBm
	Limit-3 ABS1 Stop Level	-23.5 dBm
	Limit-1 Fail Logic	ABS1
	Limit-2 Fail Logic	ABS1
	Limit-3 Fail Logic	ABS1
	Limit-4 Fail Logic	Off
	Limit-5 Fail Logic	Off
	Limit-6 Fail Logic	Off

Table C-5 Standard parameters for Spectrum Emission Mask (Cont'd)

Standard	Parameter Name	Setting
LTE Uplink (NS-06/07 1.4MHz) LTE TDD Uplink (NS-06/07 1.4MHz)	Limit Side	Both
	Noise Cancel	Off
	Reference Mode	Channel
	Channel BW	1.4 MHz
	RBW	30 kHz
	Sweep Time	500 ms
	Auto Sweep Time Select	Normal
	Detection	RMS
	Trace Point	501
	Filter Type	Rect
	Offset-1 Start Freq	0.715 MHz
	Offset-2 Start Freq	0.850 MHz
	Offset-3 Start Freq	2.2 MHz
	Offset-4 Start Freq	3.7 MHz
	Offset-1 Stop Freq	0.785 MHz
	Offset-2 Stop Freq	1.65 MHz
	Offset-3 Stop Freq	2.7 MHz
	Offset-4 Stop Freq	5.2 MHz
	Offset-1/2/3/4 Reference Level	Auto
	Offset-1 RBW	30 kHz
	Offset-2 RBW	100 kHz
	Offset-3 RBW	1 MHz
	Offset-4 RBW	1 MHz
	Offset-1 Sweep Time	400 ms
	Offset-2 Sweep Time	100 ms
	Offset-3 Sweep Time	50 ms
	Offset-4 Sweep Time	200 ms
	Offset-1/2/3/4 Auto Sweep Time Select	Normal
	Offset-1 Detection	RMS
	Offset-2 Detection	RMS
	Offset-3 Detection	RMS
	Offset-4 Detection	RMS
Offset-1 Trace Point	401	
Offset-2 Trace Point	101	
Offset-3 Trace Point	51	
Offset-4 Trace Point	201	

Table C-5 Standard parameters for Spectrum Emission Mask (Cont'd)

Standard	Parameter Name	Setting
LTE Uplink (NS-06/07 1.4MHz) LTE TDD Uplink (NS-06/07 1.4MHz) (Cont'd)	Offset-1 Integrate BW	Auto
	Offset-2 Integrate BW	Auto
	Offset-3 Integrate BW	Auto
	Offset-4 Integrate BW	Auto
	Offset-1 On/Off	On
	Offset-2 On/Off	On
	Offset-3 On/Off	On
	Offset-4 On/Off	On
	Offset-5 On/Off	Off
	Offset-6 On/Off	Off
	Limit-1 ABS1 Start Level	-11.5 dBm
	Limit-2 ABS1 Start Level	-11.5 dBm
	Limit-3 ABS1 Start Level	-11.5 dBm
	Limit-4 ABS1 Start Level	-23.5 dBm
	Limit-1 ABS1 Stop Level	-11.5 dBm
	Limit-2 ABS1 Stop Level	-11.5 dBm
	Limit-3 ABS1 Stop Level	-11.5 dBm
	Limit-4 ABS1 Stop Level	-23.5 dBm
Limit-1 Fail Logic	ABS1	
Limit-2 Fail Logic	ABS1	
Limit-3 Fail Logic	ABS1	
Limit-4 Fail Logic	ABS1	
Limit-5 Fail Logic	Off	
Limit-6 Fail Logic	Off	

Table C-5 Standard parameters for Spectrum Emission Mask (Cont'd)

Standard	Parameter Name	Setting	
LTE Uplink (NS-06/07 3MHz)	Limit Side	Both	
	Noise Cancel	Off	
	Reference Mode	Channel	
	Channel BW	3 MHz	
	RBW	30 kHz	
	Sweep Time	1000 ms	
	Auto Sweep Time Select	Normal	
	Detection	RMS	
	Trace Point	1001	
	Filter Type	Rect	
	Offset-1 Start Freq	1.515 MHz	
	Offset-2 Start Freq	1.650 MHz	
	Offset-3 Start Freq	3 MHz	
	Offset-4 Start Freq	6.9997 MHz	
	Offset-1 Stop Freq	1.585 MHz	
	Offset-2 Stop Freq	2.45 MHz	
	Offset-3 Stop Freq	6 MHz	
	Offset-4 Stop Freq	7 MHz	
	Offset-1/2/3/4 Reference Level	Auto	
	LTE TDD Uplink (NS-06/07 3MHz)	Offset-1 RBW	30 kHz
		Offset-2 RBW	100 kHz
		Offset-3 RBW	1 MHz
		Offset-4 RBW	1 MHz
		Offset-1 Sweep Time	400 ms
		Offset-2 Sweep Time	100 ms
		Offset-3 Sweep Time	40 ms
		Offset-4 Sweep Time	10 ms
		Offset-1/2/3/4 Auto Sweep Time Select	Normal
		Offset-1 Detection	RMS
		Offset-2 Detection	RMS
		Offset-3 Detection	RMS
		Offset-4 Detection	RMS
	Offset-1 Trace Point	401	
	Offset-2 Trace Point	101	
	Offset-3 Trace Point	41	
	Offset-4 Trace Point	11	

Table C-5 Standard parameters for Spectrum Emission Mask (Cont'd)

Standard	Parameter Name	Setting
LTE Uplink (NS-06/07 3MHz)	Offset-1 Integrate BW	Auto
	Offset-2 Integrate BW	Auto
	Offset-3 Integrate BW	Auto
	Offset-4 Integrate BW	Auto
	Offset-1 On/Off	On
	Offset-2 On/Off	On
	Offset-3 On/Off	On
	Offset-4 On/Off	On
	Offset-5 On/Off	Off
	Offset-6 On/Off	Off
	Limit-1 ABS1 Start Level	-11.5 dBm
	Limit-2 ABS1 Start Level	-11.5 dBm
LTE TDD Uplink (NS-06/07 3MHz) (Cont'd)	Limit-3 ABS1 Start Level	-11.5 dBm
	Limit-4 ABS1 Start Level	-23.5 dBm
	Limit-1 ABS1 Stop Level	-11.5 dBm
	Limit-2 ABS1 Stop Level	-11.5 dBm
	Limit-3 ABS1 Stop Level	-11.5 dBm
	Limit-4 ABS1 Stop Level	-23.5 dBm
	Limit-1 Fail Logic	ABS1
	Limit-2 Fail Logic	ABS1
	Limit-3 Fail Logic	ABS1
	Limit-4 Fail Logic	ABS1
Limit-5 Fail Logic	Off	
Limit-6 Fail Logic	Off	

Table C-5 Standard parameters for Spectrum Emission Mask (Cont'd)

Standard	Parameter Name	Setting
LTE Uplink (NS-06/07 5MHz) LTE TDD Uplink (NS-06/07 5MHz)	Limit Side	Both
	Noise Cancel	Off
	Reference Mode	Channel
	Channel BW	5 MHz
	RBW	100 kHz
	Sweep Time	500 ms
	Auto Sweep Time Select	Normal
	Detection	RMS
	Trace Point	501
	Filter Type	Rect
	Offset-1 Start Freq	2.515 MHz
	Offset-2 Start Freq	2.650 MHz
	Offset-3 Start Freq	4 MHz
	Offset-4 Start Freq	9 MHz
	Offset-1 Stop Freq	2.585 MHz
	Offset-2 Stop Freq	3.45 MHz
	Offset-3 Stop Freq	8 MHz
	Offset-4 Stop Freq	12 MHz
	Offset-1/2/3/4 Reference Level	Auto
	Offset-1 RBW	30 kHz
	Offset-2 RBW	100 kHz
	Offset-3 RBW	1 MHz
	Offset-4 RBW	1 MHz
	Offset-1 Sweep Time	400 ms
	Offset-2 Sweep Time	100 ms
	Offset-3 Sweep Time	40 ms
	Offset-4 Sweep Time	40 ms
	Offset-1/2/3/4 Auto Sweep Time Select	Normal
	Offset-1 Detection	RMS
	Offset-2 Detection	RMS
	Offset-3 Detection	RMS
	Offset-4 Detection	RMS
Offset-1 Trace Point	401	
Offset-2 Trace Point	101	
Offset-3 Trace Point	41	
Offset-4 Trace Point	41	

Table C-5 Standard parameters for Spectrum Emission Mask (Cont'd)

Standard	Parameter Name	Setting
LTE Uplink (NS-06/07 5MHz)	Offset-1 Integrate BW	Auto
	Offset-2 Integrate BW	Auto
	Offset-3 Integrate BW	Auto
	Offset-4 Integrate BW	Auto
	Offset-1 On/Off	On
	Offset-2 On/Off	On
	Offset-3 On/Off	On
	Offset-4 On/Off	On
	Offset-5 On/Off	Off
	Offset-6 On/Off	Off
	Limit-1 ABS1 Start Level	-13.5 dBm
	Limit-2 ABS1 Start Level	-11.5 dBm
LTE TDD Uplink (NS-06/07 5MHz) (Cont'd)	Limit-3 ABS1 Start Level	-11.5 dBm
	Limit-4 ABS1 Start Level	-23.5 dBm
	Limit-1 ABS1 Stop Level	-13.5 dBm
	Limit-2 ABS1 Stop Level	-11.5 dBm
	Limit-3 ABS1 Stop Level	-11.5 dBm
	Limit-4 ABS1 Stop Level	-23.5 dBm
	Limit-1 Fail Logic	ABS1
	Limit-2 Fail Logic	ABS1
	Limit-3 Fail Logic	ABS1
	Limit-4 Fail Logic	ABS1
	Limit-5 Fail Logic	Off
	Limit-6 Fail Logic	Off

Table C-5 Standard parameters for Spectrum Emission Mask (Cont'd)

Standard	Parameter Name	Setting
LTE Uplink (NS-06/07 10MHz) LTE TDD Uplink (NS-06/07 10MHz)	Limit Side	Both
	Noise Cancel	Off
	Reference Mode	Channel
	Channel BW	10 MHz
	RBW	300 kHz
	Sweep Time	400 ms
	Auto Sweep Time Select	Normal
	Detection	RMS
	Trace Point	401
	Filter Type	Rect
	Offset-1 Start Freq	5.015 MHz
	Offset-2 Start Freq	5.150 MHz
	Offset-3 Start Freq	6.5 MHz
	Offset-4 Start Freq	15.5 MHz
	Offset-1 Stop Freq	5.085 MHz
	Offset-2 Stop Freq	5.950 MHz
	Offset-3 Stop Freq	14.5 MHz
	Offset-4 Stop Freq	19.5 MHz
	Offset-1/2/3/4 Reference Level	Auto
	Offset-1 RBW	30 kHz
	Offset-2 RBW	100 kHz
	Offset-3 RBW	1 MHz
	Offset-4 RBW	1 MHz
	Offset-1 Sweep Time	400 ms
	Offset-2 Sweep Time	100 ms
	Offset-3 Sweep Time	100 ms
	Offset-4 Sweep Time	40 ms
	Offset-1/2/3/4 Auto Sweep Time Select	Normal
	Offset-1 Detection	RMS
	Offset-2 Detection	RMS
	Offset-3 Detection	RMS
	Offset-4 Detection	RMS
Offset-1 Trace Point	401	
Offset-2 Trace Point	101	
Offset-3 Trace Point	101	
Offset-4 Trace Point	41	

Table C-5 Standard parameters for Spectrum Emission Mask (Cont'd)

Standard	Parameter Name	Setting
LTE Uplink (NS-06/07 10MHz)	Offset-1 Integrate BW	Auto
	Offset-2 Integrate BW	Auto
	Offset-3 Integrate BW	Auto
	Offset-4 Integrate BW	Auto
	Offset-1 On/Off	On
	Offset-2 On/Off	On
	Offset-3 On/Off	On
	Offset-4 On/Off	On
	Offset-5 On/Off	Off
	Offset-6 On/Off	Off
	Limit-1 ABS1 Start Level	-16.5 dBm
	Limit-2 ABS1 Start Level	-11.5 dBm
	Limit-3 ABS1 Start Level	-11.5 dBm
	Limit-4 ABS1 Start Level	-23.5 dBm
	Limit-1 ABS1 Stop Level	-16.5 dBm
	Limit-2 ABS1 Stop Level	-11.5 dBm
	Limit-3 ABS1 Stop Level	-11.5 dBm
	Limit-4 ABS1 Stop Level	-23.5 dBm
LTE TDD Uplink (NS-06/07 10MHz) (Cont'd)	Limit-1 Fail Logic	ABS1
	Limit-2 Fail Logic	ABS1
	Limit-3 Fail Logic	ABS1
	Limit-4 Fail Logic	ABS1
	Limit-5 Fail Logic	Off
	Limit-6 Fail Logic	Off

Table C-5 Standard parameters for Spectrum Emission Mask (Cont'd)

Standard	Parameter Name	Setting
LTE Uplink (JAPAN 5MHz)	Limit Side	Both
	Noise Cancel	Off
	Reference Mode	Channel
	Channel BW	5 MHz
	RBW	100 kHz
	Sweep Time	500 ms
	Auto Sweep Time Select	Normal
	Detection	RMS
	Trace Point	501
	Filter Type	Rect
	Offset-1 Start Freq	2.5 MHz
	Offset-2 Start Freq	3.5. MHz
	Offset-3 Start Freq	7.5 MHz
	Offset-4 Start Freq	8.5 MHz
	Offset-1 Stop Freq	3.5 MHz
	Offset-2 Stop Freq	7.5 MHz
	Offset-3 Stop Freq	8.5 MHz
	Offset-4 Stop Freq	12.5 MHz
	Offset-1/2/3/4 Reference Level	Auto
	Offset-1 RBW	30 kHz
	Offset-2 RBW	1 MHz
	Offset-3 RBW	1 MHz
	Offset-4 RBW	1 MHz
	Offset-1 Sweep Time	400 ms
	Offset-2 Sweep Time	400 ms
	Offset-3 Sweep Time	400 ms
	Offset-4 Sweep Time	400 ms
	Offset-1/2/3/4 Auto Sweep Time Select	Normal
	Offset-1 Detection	RMS
	Offset-2 Detection	RMS
	Offset-3 Detection	RMS
	Offset-4 Detection	RMS
	Offset-1 Trace Point	401
Offset-2 Trace Point	401	
Offset-3 Trace Point	401	
Offset-4 Trace Point	401	

Table C-5 Standard parameters for Spectrum Emission Mask (Cont'd)

Standard	Parameter Name	Setting
LTE Uplink (JAPAN 5MHz) (Cont'd)	Offset-1 Integrate BW	Auto
	Offset-2 Integrate BW	Auto
	Offset-3 Integrate BW	Auto
	Offset-4 Integrate BW	Auto
	Offset-1 On/Off	On
	Offset-2 On/Off	On
	Offset-3 On/Off	On
	Offset-4 On/Off	On
	Offset-5 On/Off	Off
	Offset-6 On/Off	Off
	Limit-1 ABS1 Start Level	-13.5 dBm
	Limit-2 ABS1 Start Level	-8.5 dBm
	Limit-3 ABS1 Start Level	-11.5 dBm
	Limit-4 ABS1 Start Level	-23.5 dBm
	Limit-1 ABS1 Stop Level	-13.5 dBm
	Limit-2 ABS1 Stop Level	-8.5 dBm
	Limit-3 ABS1 Stop Level	-11.5 dBm
	Limit-4 ABS1 Stop Level	-23.5 dBm
	Limit-1 Fail Logic	ABS1
	Limit-2 Fail Logic	ABS1
	Limit-3 Fail Logic	ABS1
	Limit-4 Fail Logic	ABS1
Limit-5 Fail Logic	Off	
Limit-6 Fail Logic	Off	

Table C-5 Standard parameters for Spectrum Emission Mask (Cont'd)

Standard	Parameter Name	Setting
LTE Uplink (JAPAN 10MHz)	Limit Side	Both
	Noise Cancel	Off
	Reference Mode	Channel
	Channel BW	10 MHz
	RBW	300 kHz
	Sweep Time	400 ms
	Auto Sweep Time Select	Normal
	Detection	RMS
	Trace Point	401
	Filter Type	Rect
	Offset-1 Start Freq	5 MHz
	Offset-2 Start Freq	6 MHz
	Offset-3 Start Freq	10 MHz
	Offset-4 Start Freq	15 MHz
	Offset-1 Stop Freq	6 MHz
	Offset-2 Stop Freq	10 MHz
	Offset-3 Stop Freq	15 MHz
	Offset-4 Stop Freq	20 MHz
	Offset-1/2/3/4 Reference Level	Auto
	Offset-1 RBW	30 kHz
	Offset-2 RBW	1 MHz
	Offset-3 RBW	1 MHz
	Offset-4 RBW	1 MHz
	Offset-1 Sweep Time	400 ms
	Offset-2 Sweep Time	400 ms
	Offset-3 Sweep Time	400 ms
	Offset-4 Sweep Time	400 ms
	Offset-1/2/3/4 Auto Sweep Time Select	Normal
	Offset-1 Detection	RMS
	Offset-2 Detection	RMS
	Offset-3 Detection	RMS
	Offset-4 Detection	RMS
	Offset-1 Trace Point	401
Offset-2 Trace Point	401	
Offset-3 Trace Point	401	
Offset-4 Trace Point	401	

Table C-5 Standard parameters for Spectrum Emission Mask (Cont'd)

Standard	Parameter Name	Setting
LTE Uplink (JAPAN 10MHz) (Cont'd)	Offset-1 Integrate BW	Auto
	Offset-2 Integrate BW	Auto
	Offset-3 Integrate BW	Auto
	Offset-4 Integrate BW	Auto
	Offset-1 On/Off	On
	Offset-2 On/Off	On
	Offset-3 On/Off	On
	Offset-4 On/Off	On
	Offset-5 On/Off	Off
	Offset-6 On/Off	Off
	Limit-1 ABS1 Start Level	-16.5 dBm
	Limit-2 ABS1 Start Level	-8.5 dBm
	Limit-3 ABS1 Start Level	-11.5 dBm
	Limit-4 ABS1 Start Level	-23.5 dBm
	Limit-1 ABS1 Stop Level	-16.5 dBm
	Limit-2 ABS1 Stop Level	-8.5 dBm
	Limit-3 ABS1 Stop Level	-11.5 dBm
	Limit-4 ABS1 Stop Level	-23.5 dBm
	Limit-1 Fail Logic	ABS1
	Limit-2 Fail Logic	ABS1
	Limit-3 Fail Logic	ABS1
	Limit-4 Fail Logic	ABS1
	Limit-5 Fail Logic	Off
	Limit-6 Fail Logic	Off

Table C-5 Standard parameters for Spectrum Emission Mask (Cont'd)

Standard	Parameter Name	Setting
LTE Uplink (JAPAN 15MHz)	Limit Side	Both
	Noise Cancel	Off
	Reference Mode	Channel
	Channel BW	15 MHz
	RBW	300 kHz
	Sweep Time	500 ms
	Auto Sweep Time Select	Normal
	Detection	RMS
	Trace Point	501
	Filter Type	Rect
	Offset-1 Start Freq	7.5 MHz
	Offset-2 Start Freq	8.5 MHz
	Offset-3 Start Freq	12.5 MHz
	Offset-4 Start Freq	22.5 MHz
	Offset-1 Stop Freq	8.5 MHz
	Offset-2 Stop Freq	12.5 MHz
	Offset-3 Stop Freq	22.5 MHz
	Offset-4 Stop Freq	27.5 MHz
	Offset-1/2/3/4 Reference Level	Auto
	Offset-1 RBW	30 kHz
	Offset-2 RBW	1 MHz
	Offset-3 RBW	1 MHz
	Offset-4 RBW	1 MHz
	Offset-1 Sweep Time	400 ms
	Offset-2 Sweep Time	400 ms
	Offset-3 Sweep Time	400 ms
	Offset-4 Sweep Time	400 ms
	Offset-1/2/3/4 Auto Sweep Time Select	Normal
	Offset-1 Detection	RMS
	Offset-2 Detection	RMS
	Offset-3 Detection	RMS
	Offset-4 Detection	RMS
Offset-1 Trace Point	401	
Offset-2 Trace Point	401	
Offset-3 Trace Point	401	
Offset-4 Trace Point	401	

Table C-5 Standard parameters for Spectrum Emission Mask (Cont'd)

Standard	Parameter Name	Setting
LTE Uplink (JAPAN 15MHz) (Cont'd)	Offset-1 Integrate BW	Auto
	Offset-2 Integrate BW	Auto
	Offset-3 Integrate BW	Auto
	Offset-4 Integrate BW	Auto
	Offset-1 On/Off	On
	Offset-2 On/Off	On
	Offset-3 On/Off	On
	Offset-4 On/Off	On
	Offset-5 On/Off	Off
	Offset-6 On/Off	Off
	Limit-1 ABS1 Start Level	-18.5 dBm
	Limit-2 ABS1 Start Level	-8.5 dBm
	Limit-3 ABS1 Start Level	-11.5 dBm
	Limit-4 ABS1 Start Level	-23.5 dBm
	Limit-1 ABS1 Stop Level	-18.5 dBm
	Limit-2 ABS1 Stop Level	-8.5 dBm
	Limit-3 ABS1 Stop Level	-11.5 dBm
	Limit-4 ABS1 Stop Level	-23.5 dBm
	Limit-1 Fail Logic	ABS1
	Limit-2 Fail Logic	ABS1
	Limit-3 Fail Logic	ABS1
	Limit-4 Fail Logic	ABS1
Limit-5 Fail Logic	Off	
Limit-6 Fail Logic	Off	

Table C-5 Standard parameters for Spectrum Emission Mask (Cont'd)

Standard	Parameter Name	Setting
LTE Uplink (JAPAN 20MHz)	Limit Side	Both
	Noise Cancel	Off
	Reference Mode	Channel
	Channel BW	20 MHz
	RBW	300 kHz
	Sweep Time	1000 ms
	Auto Sweep Time Select	Normal
	Detection	RMS
	Trace Point	1001
	Filter Type	Rect
	Offset-1 Start Freq	10 MHz
	Offset-2 Start Freq	11 MHz
	Offset-3 Start Freq	15 MHz
	Offset-4 Start Freq	30 MHz
	Offset-1 Stop Freq	11 MHz
	Offset-2 Stop Freq	15 MHz
	Offset-3 Stop Freq	30 MHz
	Offset-4 Stop Freq	35 MHz
	Offset-1/2/3/4 Reference Level	Auto
	Offset-1 RBW	30 kHz
	Offset-2 RBW	1 MHz
	Offset-3 RBW	1 MHz
	Offset-4 RBW	1 MHz
	Offset-1 Sweep Time	400 ms
	Offset-2 Sweep Time	400 ms
	Offset-3 Sweep Time	400 ms
	Offset-4 Sweep Time	400 ms
	Offset-1/2/3/4 Auto Sweep Time Select	Normal
	Offset-1 Detection	RMS
	Offset-2 Detection	RMS
	Offset-3 Detection	RMS
	Offset-4 Detection	RMS
Offset-1 Trace Point	401	
Offset-2 Trace Point	401	
Offset-3 Trace Point	401	
Offset-4 Trace Point	401	

Table C-5 Standard parameters for Spectrum Emission Mask (Cont'd)

Standard	Parameter Name	Setting
LTE Uplink (JAPAN 20MHz) (Cont'd)	Offset-1 Integrate BW	Auto
	Offset-2 Integrate BW	Auto
	Offset-3 Integrate BW	Auto
	Offset-4 Integrate BW	Auto
	Offset-1 On/Off	On
	Offset-2 On/Off	On
	Offset-3 On/Off	On
	Offset-4 On/Off	On
	Offset-5 On/Off	Off
	Offset-6 On/Off	Off
	Limit-1 ABS1 Start Level	-19.5 dBm
	Limit-2 ABS1 Start Level	-8.5 dBm
	Limit-3 ABS1 Start Level	-11.5 dBm
	Limit-4 ABS1 Start Level	-23.5 dBm
	Limit-1 ABS1 Stop Level	-19.5 dBm
	Limit-2 ABS1 Stop Level	-8.5 dBm
	Limit-3 ABS1 Stop Level	-11.5 dBm
	Limit-4 ABS1 Stop Level	-23.5 dBm
	Limit-1 Fail Logic	ABS1
	Limit-2 Fail Logic	ABS1
	Limit-3 Fail Logic	ABS1
	Limit-4 Fail Logic	ABS1
	Limit-5 Fail Logic	Off
	Limit-6 Fail Logic	Off

TD-SCDMA

Table C-5 Standard parameters for Spectrum Emission Mask (Cont'd)

Standard	Parameter Name	Setting
TD-SCDMA DL Trace Point Tune (34dBm ≤ P)	Limit Side	Both
	Noise Cancel	Off
	Reference Mode	Channel
	Channel BW	1.6 MHz
	RBW	30 kHz
	Sweep Time Switch	Manual
	Sweep Time Freq. Domain	136 ms
	Auto Sweep Time Select	Normal
	Detection	RMS
	Trace Point	201
	Filter Type	Rect
	Offset-1 Start Freq	815 kHz
	Offset-2 Start Freq	1.015 MHz
	Offset-3 Start Freq	1.815 MHz
	Offset-4 Start Freq	2.3 MHz
	Offset-1 Stop Freq	1.015 MHz
	Offset-2 Stop Freq	1.815 MHz
	Offset-3 Stop Freq	2.3 MHz
	Offset-4 Stop Freq	4.0 MHz
	Offset-1 Reference Level	Auto
	Offset-2 Reference Level	Auto
	Offset-3 Reference Level	Auto
	Offset-4 Reference Level	Auto
	Offset-1 RBW	30 kHz
	Offset-2 RBW	30 kHz
	Offset-3 RBW	30 kHz
	Offset-4 RBW	30 kHz
	Offset-1 Sweep Time	28 ms
Offset-2 Sweep Time	136 ms	
Offset-3 Sweep Time	69 ms	
Offset-4 Sweep Time	676 ms	

Table C-5 Standard parameters for Spectrum Emission Mask (Cont'd)

Standard	Parameter Name	Setting
TD-SCDMA DL Trace Point Tune (34dBm ≤ P)	Offset-1 Auto Sweep Time Select	Normal
	Offset-2 Auto Sweep Time Select	Normal
	Offset-3 Auto Sweep Time Select	Normal
	Offset-4 Auto Sweep Time Select	Normal
	Offset-1 Detection	RMS
	Offset-2 Detection	RMS
	Offset-3 Detection	RMS
	Offset-4 Detection	RMS
	Offset-1 Trace Point	41
	Offset-2 Trace Point	201
	Offset-3 Trace Point	101
	Offset-4 Trace Point	1001
	Offset-1 Integrate BW	Auto
	Offset-2 Integrate BW	Auto
	Offset-3 Integrate BW	Auto
	Offset-4 Integrate BW	1 MHz
	Offset-1 On/Off	On
	Offset-2 On/Off	On
	Offset-3 On/Off	On
	Offset-4 On/Off	On
	Limit-1 ABS1 Start Level	-20.0 dBm
	Limit-2 ABS1 Start Level	-20.0 dBm
	Limit-3 ABS1 Start Level	-28.0 dBm
	Limit-4 ABS1 Start Level	-13.0 dBm
	Limit-1 ABS1 Stop Level	-20.0 dBm
	Limit-2 ABS1 Stop Level	-28.0 dBm
	Limit-3 ABS1 Stop Level	-28.0 dBm
	Limit-4 ABS1 Stop Level	-13.0 dBm
	Limit-1 Fail Logic	ABS1
	Limit-2 Fail Logic	ABS1
	Limit-3 Fail Logic	ABS1
	Limit-4 Fail Logic	ABS1

Table C-5 Standard parameters for Spectrum Emission Mask (Cont'd)

Standard	Parameter Name	Setting
TD-SCDMA DL Trace Point Tune (26dBm ≤ P < 34dBm)	Limit Side	Both
	Noise Cancel	Off
	Reference Mode	Channel
	Channel BW	1.6 MHz
	RBW	30 kHz
	Sweep Time Switch	Manual
	Sweep Time Freq. Domain	136 ms
	Auto Sweep Time Select	Normal
	Detection	RMS
	Trace Point	201
	Filter Type	Rect
	Offset-1 Start Freq	815 kHz
	Offset-2 Start Freq	1.015 MHz
	Offset-3 Start Freq	1.815 MHz
	Offset-4 Start Freq	2.3 MHz
	Offset-1 Stop Freq	1.015 MHz
	Offset-2 Stop Freq	1.815 MHz
	Offset-3 Stop Freq	2.3 MHz
	Offset-4 Stop Freq	4.0 MHz
	Offset-1 Reference Level	Auto
	Offset-2 Reference Level	Auto
	Offset-3 Reference Level	Auto
	Offset-4 Reference Level	Auto
	Offset-1 RBW	30 kHz
	Offset-2 RBW	30 kHz
	Offset-3 RBW	30 kHz
	Offset-4 RBW	30 kHz
	Offset-1 Sweep Time	28 ms
Offset-2 Sweep Time	136 ms	
Offset-3 Sweep Time	69 ms	
Offset-4 Sweep Time	676 ms	

Table C-5 Standard parameters for Spectrum Emission Mask (Cont'd)

Standard	Parameter Name	Setting
TD-SCDMA DL Trace Point Tune (26dBm ≤ P < 34dBm)	Offset-1 Auto Sweep Time Select	Normal
	Offset-2 Auto Sweep Time Select	Normal
	Offset-3 Auto Sweep Time Select	Normal
	Offset-4 Auto Sweep Time Select	Normal
	Offset-1 Detection	RMS
	Offset-2 Detection	RMS
	Offset-3 Detection	RMS
	Offset-4 Detection	RMS
	Offset-1 Trace Point	41
	Offset-2 Trace Point	201
	Offset-3 Trace Point	101
	Offset-4 Trace Point	1001
	Offset-1 Integrate BW	Auto
	Offset-2 Integrate BW	Auto
	Offset-3 Integrate BW	Auto
	Offset-4 Integrate BW	1 MHz
	Offset-1 On/Off	On
	Offset-2 On/Off	On
	Offset-3 On/Off	On
	Offset-4 On/Off	On
	Limit-1 REL Start Level	-54.0 dB
	Limit-2 REL Start Level	-54.0 dB
	Limit-3 REL Start Level	-62.0 dB
	Limit-4 REL Start Level	-47.0 dB
	Limit-1 REL Stop Level	-54.0 dB
	Limit-2 REL Stop Level	-62.0 dB
	Limit-3 REL Stop Level	-62.0 dB
	Limit-4 REL Stop Level	-47.0 dB
	Limit-1 Fail Logic	REL
	Limit-2 Fail Logic	REL
	Limit-3 Fail Logic	REL
	Limit-4 Fail Logic	REL

Table C-5 Standard parameters for Spectrum Emission Mask (Cont'd)

Standard	Parameter Name	Setting
TD-SCDMA DL Trace Point Tune (P < 26dBm)	Limit Side	Both
	Noise Cancel	Off
	Reference Mode	Channel
	Channel BW	1.6 MHz
	RBW	30 kHz
	Sweep Time Switch	Manual
	Sweep Time Freq. Domain	136 ms
	Auto Sweep Time Select	Normal
	Detection	RMS
	Trace Point	201
	Filter Type	Rect
	Offset-1 Start Freq	815 kHz
	Offset-2 Start Freq	1.015 MHz
	Offset-3 Start Freq	1.815 MHz
	Offset-4 Start Freq	2.3 MHz
	Offset-1 Stop Freq	1.015 MHz
	Offset-2 Stop Freq	1.815 MHz
	Offset-3 Stop Freq	2.3 MHz
	Offset-4 Stop Freq	4.0 MHz
	Offset-1 Reference Level	Auto
	Offset-2 Reference Level	Auto
	Offset-3 Reference Level	Auto
	Offset-4 Reference Level	Auto
	Offset-1 RBW	30 kHz
	Offset-2 RBW	30 kHz
	Offset-3 RBW	30 kHz
	Offset-4 RBW	30 kHz
	Offset-1 Sweep Time	28 ms
	Offset-2 Sweep Time	136 ms
	Offset-3 Sweep Time	69 ms
Offset-4 Sweep Time	676 ms	

Table C-5 Standard parameters for Spectrum Emission Mask (Cont'd)

Standard	Parameter Name	Setting
TD-SCDMA DL Trace Point Tune (P < 26dBm)	Offset-1 Auto Sweep Time Select	Normal
	Offset-2 Auto Sweep Time Select	Normal
	Offset-3 Auto Sweep Time Select	Normal
	Offset-4 Auto Sweep Time Select	Normal
	Offset-1 Detection	RMS
	Offset-2 Detection	RMS
	Offset-3 Detection	RMS
	Offset-4 Detection	RMS
	Offset-1 Trace Point	41
	Offset-2 Trace Point	201
	Offset-3 Trace Point	101
	Offset-4 Trace Point	1001
	Offset-1 Integrate BW	Auto
	Offset-2 Integrate BW	Auto
	Offset-3 Integrate BW	Auto
	Offset-4 Integrate BW	1 MHz
	Offset-1 On/Off	On
	Offset-2 On/Off	On
	Offset-3 On/Off	On
	Offset-4 On/Off	On
	Limit-1 ABS1 Start Level	-28.0 dBm
	Limit-2 ABS1 Start Level	-28.0 dBm
	Limit-3 ABS1 Start Level	-36.0 dBm
	Limit-4 ABS1 Start Level	-21.0 dBm
	Limit-1 ABS1 Stop Level	-28.0 dBm
	Limit-2 ABS1 Stop Level	-36.0 dBm
	Limit-3 ABS1 Stop Level	-36.0 dBm
	Limit-4 ABS1 Stop Level	-21.0 dBm
	Limit-1 Fail Logic	ABS1
	Limit-2 Fail Logic	ABS1
	Limit-3 Fail Logic	ABS1
	Limit-4 Fail Logic	ABS1

Table C-5 Standard parameters for Spectrum Emission Mask (Cont'd)

Standard	Parameter Name	Setting
TD-SCDMA UL Trace Point Tune ($-53.5\text{dBm} \leq P$)	Limit Side	Both
	Noise Cancel	Off
	Reference Mode	Channel
	Channel BW	1.6 MHz
	RBW	30 kHz
	Sweep Time Switch	Manual
	Sweep Time Freq. Domain	136 ms
	Auto Sweep Time Select	Normal
	Detection	RMS
	Trace Point	201
	Filter Type	Rect
	Offset-1 Start Freq	815 kHz
	Offset-2 Start Freq	1.815 MHz
	Offset-3 Start Freq	2.4 MHz
	Offset-1 Stop Freq	1.815 MHz
	Offset-2 Stop Freq	2.4 MHz
	Offset-3 Stop Freq	4.0 MHz
	Offset-1 Reference Level	Auto
	Offset-2 Reference Level	Auto
	Offset-3 Reference Level	Auto
	Offset-1 RBW	30 kHz
	Offset-2 RBW	30 kHz
	Offset-3 RBW	30 kHz
	Offset-1 Sweep Time	136 ms
Offset-2 Sweep Time	69 ms	
Offset-3 Sweep Time	676 ms	

Table C-5 Standard parameters for Spectrum Emission Mask (Cont'd)

Standard	Parameter Name	Setting
TD-SCDMA UL Trace Point Tune ($-53.5\text{dBm} \leq P$)	Offset-1 Auto Sweep Time Select	Normal
	Offset-2 Auto Sweep Time Select	Normal
	Offset-3 Auto Sweep Time Select	Normal
	Offset-1 Detection	RMS
	Offset-2 Detection	RMS
	Offset-3 Detection	RMS
	Offset-1 Trace Point	201
	Offset-2 Trace Point	101
	Offset-3 Trace Point	1001
	Offset-1 Integrate BW	Auto
	Offset-2 Integrate BW	Auto
	Offset-3 Integrate BW	Auto
	Offset-1 On/Off	On
	Offset-2 On/Off	On
	Offset-3 On/Off	On
	Limit-1 REL Start Level	-33.5 dB
	Limit-2 REL Start Level	-47.5 dB
	Limit-3 REL Start Level	-42.5 dB
	Limit-1 REL Stop Level	-47.5 dB
	Limit-2 REL Stop Level	-64.5 dB
	Limit-3 REL Stop Level	-42.5 dB
	Limit-1 Fail Logic	REL
	Limit-2 Fail Logic	REL
	Limit-3 Fail Logic	REL

Table C-5 Standard parameters for Spectrum Emission Mask (Cont'd)

Standard	Parameter Name	Setting
TD-SCDMA UL Trace Point Tune (-55dBm ≤ P)	Limit Side	Both
	Noise Cancel	Off
	Reference Mode	Channel
	Channel BW	1.6 MHz
	RBW	30 kHz
	Sweep Time Switch	Manual
	Sweep Time Freq. Domain	136 ms
	Auto Sweep Time Select	Normal
	Detection	RMS
	Trace Point	201
	Filter Type	Rect
	Offset-1 Start Freq	815 kHz
	Offset-2 Start Freq	1.815 MHz
	Offset-3 Start Freq	2.4 MHz
	Offset-1 Stop Freq	1.815 MHz
	Offset-2 Stop Freq	2.4 MHz
	Offset-3 Stop Freq	4.0 MHz
	Offset-1 Reference Level	Auto
	Offset-2 Reference Level	Auto
	Offset-3 Reference Level	Auto
	Offset-1 RBW	30 kHz
	Offset-2 RBW	30 kHz
	Offset-3 RBW	30 kHz
	Offset-1 Sweep Time	136 ms
Offset-2 Sweep Time	69 ms	
Offset-3 Sweep Time	676 ms	

Table C-5 Standard parameters for Spectrum Emission Mask (Cont'd)

Standard	Parameter Name	Setting
TD-SCDMA UL Trace Point Tune (-55dBm ≤ P)	Offset-1 Auto Sweep Time Select	Normal
	Offset-2 Auto Sweep Time Select	Normal
	Offset-3 Auto Sweep Time Select	Normal
	Offset-1 Detection	RMS
	Offset-2 Detection	RMS
	Offset-3 Detection	RMS
	Offset-1 Trace Point	201
	Offset-2 Trace Point	101
	Offset-3 Trace Point	1001
	Offset-1 Integrate BW	Auto
	Offset-2 Integrate BW	Auto
	Offset-3 Integrate BW	Auto
	Offset-1 On/Off	On
	Offset-2 On/Off	On
	Offset-3 On/Off	On
	Limit-1 REL Start Level	-35.0 dB
	Limit-2 REL Start Level	-49.0 dB
	Limit-3 REL Start Level	-44.0 dB
	Limit-1 REL Stop Level	-49.0 dB
	Limit-2 REL Stop Level	-66.0 dB
	Limit-3 REL Stop Level	-44.0 dB
Limit-1 Fail Logic	REL	
Limit-2 Fail Logic	REL	
Limit-3 Fail Logic	REL	

Table C-5 Standard parameters for Spectrum Emission Mask (Cont'd)

Standard	Parameter Name	Setting
TD-SCDMA Downlink Actual (34dBm ≤ P)	Limit Side	Both
	Noise Cancel	Off
	Reference Mode	Channel
	Channel BW	1.6 MHz
	RBW	30 kHz
	Sweep Time Switch	Manual
	Sweep Time Freq. Domain	676 ms
	Auto Sweep Time Select	Normal
	Detection	RMS
	Trace Point	1001
	Filter Type	Rect
	Offset-1 Start Freq	815 kHz
	Offset-2 Start Freq	1.015 MHz
	Offset-3 Start Freq	1.815 MHz
	Offset-4 Start Freq	2.3 MHz
	Offset-1 Stop Freq	1.015 MHz
	Offset-2 Stop Freq	1.815 MHz
	Offset-3 Stop Freq	2.3 MHz
	Offset-4 Stop Freq	4.0 MHz
	Offset-1 Reference Level	Auto
	Offset-2 Reference Level	Auto
	Offset-3 Reference Level	Auto
	Offset-4 Reference Level	Auto
	Offset-1 RBW	30 kHz
	Offset-2 RBW	30 kHz
	Offset-3 RBW	30 kHz
	Offset-4 RBW	30 kHz
	Offset-1 Sweep Time	676 ms
	Offset-2 Sweep Time	676 ms
	Offset-3 Sweep Time	676 ms
Offset-4 Sweep Time	676 ms	

Table C-5 Standard parameters for Spectrum Emission Mask (Cont'd)

Standard	Parameter Name	Setting
TD-SCDMA Downlink Actual (34dBm ≤ P)	Offset-1 Auto Sweep Time Select	Normal
	Offset-2 Auto Sweep Time Select	Normal
	Offset-3 Auto Sweep Time Select	Normal
	Offset-4 Auto Sweep Time Select	Normal
	Offset-1 Detection	RMS
	Offset-2 Detection	RMS
	Offset-3 Detection	RMS
	Offset-4 Detection	RMS
	Offset-1 Trace Point	1001
	Offset-2 Trace Point	1001
	Offset-3 Trace Point	1001
	Offset-4 Trace Point	1001
	Offset-1 Integrate BW	Auto
	Offset-2 Integrate BW	Auto
	Offset-3 Integrate BW	Auto
	Offset-4 Integrate BW	1 MHz
	Offset-1 On/Off	On
	Offset-2 On/Off	On
	Offset-3 On/Off	On
	Offset-4 On/Off	On
	Limit-1 ABS1 Start Level	-20.0 dBm
	Limit-2 ABS1 Start Level	-20.0 dBm
	Limit-3 ABS1 Start Level	-28.0 dBm
	Limit-4 ABS1 Start Level	-13.0 dBm
	Limit-1 ABS1 Stop Level	-20.0 dBm
	Limit-2 ABS1 Stop Level	-28.0 dBm
	Limit-3 ABS1 Stop Level	-28.0 dBm
	Limit-4 ABS1 Stop Level	-13.0 dBm
	Limit-1 Fail Logic	ABS1
	Limit-2 Fail Logic	ABS1
	Limit-3 Fail Logic	ABS1
	Limit-4 Fail Logic	ABS1

Table C-5 Standard parameters for Spectrum Emission Mask (Cont'd)

Standard	Parameter Name	Setting
TD-SCDMA Downlink Actual (26dBm ≤ P < 34dBm)	Limit Side	Both
	Noise Cancel	Off
	Reference Mode	Channel
	Channel BW	1.6 MHz
	RBW	30 kHz
	Sweep Time Switch	Manual
	Sweep Time Freq. Domain	676 ms
	Auto Sweep Time Select	Normal
	Detection	RMS
	Trace Point	1001
	Filter Type	Rect
	Offset-1 Start Freq	815 kHz
	Offset-2 Start Freq	1.015 MHz
	Offset-3 Start Freq	1.815 MHz
	Offset-4 Start Freq	2.3 MHz
	Offset-1 Stop Freq	1.015 MHz
	Offset-2 Stop Freq	1.815 MHz
	Offset-3 Stop Freq	2.3 MHz
	Offset-4 Stop Freq	4.0 MHz
	Offset-1 Reference Level	Auto
	Offset-2 Reference Level	Auto
	Offset-3 Reference Level	Auto
	Offset-4 Reference Level	Auto
	Offset-1 RBW	30 kHz
	Offset-2 RBW	30 kHz
	Offset-3 RBW	30 kHz
	Offset-4 RBW	30 kHz
	Offset-1 Sweep Time	676 ms
	Offset-2 Sweep Time	676 ms
	Offset-3 Sweep Time	676 ms
Offset-4 Sweep Time	676 ms	

Table C-5 Standard parameters for Spectrum Emission Mask (Cont'd)

Standard	Parameter Name	Setting
TD-SCDMA Downlink Actual (26dBm ≤ P < 34dBm)	Offset-1 Auto Sweep Time Select	Normal
	Offset-2 Auto Sweep Time Select	Normal
	Offset-3 Auto Sweep Time Select	Normal
	Offset-4 Auto Sweep Time Select	Normal
	Offset-1 Detection	RMS
	Offset-2 Detection	RMS
	Offset-3 Detection	RMS
	Offset-4 Detection	RMS
	Offset-1 Trace Point	1001
	Offset-2 Trace Point	1001
	Offset-3 Trace Point	1001
	Offset-4 Trace Point	1001
	Offset-1 Integrate BW	Auto
	Offset-2 Integrate BW	Auto
	Offset-3 Integrate BW	Auto
	Offset-4 Integrate BW	1 MHz
	Offset-1 On/Off	On
	Offset-2 On/Off	On
	Offset-3 On/Off	On
	Offset-4 On/Off	On
	Limit-1 REL Start Level	-54.0 dB
	Limit-2 REL Start Level	-54.0 dB
	Limit-3 REL Start Level	-62.0 dB
	Limit-4 REL Start Level	-47.0 dB
	Limit-1 REL Stop Level	-54.0 dB
	Limit-2 REL Stop Level	-62.0 dB
	Limit-3 REL Stop Level	-62.0 dB
	Limit-4 REL Stop Level	-47.0 dB
	Limit-1 Fail Logic	REL
	Limit-2 Fail Logic	REL
	Limit-3 Fail Logic	REL
	Limit-4 Fail Logic	REL

Table C-5 Standard parameters for Spectrum Emission Mask (Cont'd)

Standard	Parameter Name	Setting
TD-SCDMA Downlink Actual (P < 26dBm)	Limit Side	Both
	Noise Cancel	Off
	Reference Mode	Channel
	Channel BW	1.6 MHz
	RBW	30 kHz
	Sweep Time Switch	Manual
	Sweep Time Freq. Domain	676 ms
	Auto Sweep Time Select	Normal
	Detection	RMS
	Trace Point	1001
	Filter Type	Rect
	Offset-1 Start Freq	815 kHz
	Offset-2 Start Freq	1.015 MHz
	Offset-3 Start Freq	1.815 MHz
	Offset-4 Start Freq	2.3 MHz
	Offset-1 Stop Freq	1.015 MHz
	Offset-2 Stop Freq	1.815 MHz
	Offset-3 Stop Freq	2.3 MHz
	Offset-4 Stop Freq	4.0 MHz
	Offset-1 Reference Level	Auto
	Offset-2 Reference Level	Auto
	Offset-3 Reference Level	Auto
	Offset-4 Reference Level	Auto
	Offset-1 RBW	30 kHz
	Offset-2 RBW	30 kHz
	Offset-3 RBW	30 kHz
	Offset-4 RBW	30 kHz
	Offset-1 Sweep Time	676 ms
	Offset-2 Sweep Time	676 ms
	Offset-3 Sweep Time	676 ms
Offset-4 Sweep Time	676 ms	

Table C-5 Standard parameters for Spectrum Emission Mask (Cont'd)

Standard	Parameter Name	Setting
TD-SCDMA Downlink Actual (P < 26dBm)	Offset-1 Auto Sweep Time Select	Normal
	Offset-2 Auto Sweep Time Select	Normal
	Offset-3 Auto Sweep Time Select	Normal
	Offset-4 Auto Sweep Time Select	Normal
	Offset-1 Detection	RMS
	Offset-2 Detection	RMS
	Offset-3 Detection	RMS
	Offset-4 Detection	RMS
	Offset-1 Trace Point	1001
	Offset-2 Trace Point	1001
	Offset-3 Trace Point	1001
	Offset-4 Trace Point	1001
	Offset-1 Integrate BW	Auto
	Offset-2 Integrate BW	Auto
	Offset-3 Integrate BW	Auto
	Offset-4 Integrate BW	1 MHz
	Offset-1 On/Off	On
	Offset-2 On/Off	On
	Offset-3 On/Off	On
	Offset-4 On/Off	On
	Limit-1 ABS1 Start Level	-28.0 dBm
	Limit-2 ABS1 Start Level	-28.0 dBm
	Limit-3 ABS1 Start Level	-36.0 dBm
	Limit-4 ABS1 Start Level	-21.0 dBm
	Limit-1 ABS1 Stop Level	-28.0 dBm
	Limit-2 ABS1 Stop Level	-36.0 dBm
	Limit-3 ABS1 Stop Level	-36.0 dBm
	Limit-4 ABS1 Stop Level	-21.0 dBm
	Limit-1 Fail Logic	ABS1
	Limit-2 Fail Logic	ABS1
	Limit-3 Fail Logic	ABS1
	Limit-4 Fail Logic	ABS1

Table C-5 Standard parameters for Spectrum Emission Mask (Cont'd)

Standard	Parameter Name	Setting
TD-SCDMA Uplink Actual ($-53.5\text{dBm} \leq P$)	Limit Side	Both
	Noise Cancel	Off
	Reference Mode	Channel
	Channel BW	1.6 MHz
	RBW	30 kHz
	Sweep Time Switch	Manual
	Sweep Time Freq. Domain	676 ms
	Auto Sweep Time Select	Normal
	Detection	RMS
	Trace Point	1001
	Filter Type	Rect
	Offset-1 Start Freq	815 kHz
	Offset-2 Start Freq	1.815 MHz
	Offset-3 Start Freq	2.4 MHz
	Offset-1 Stop Freq	1.815 MHz
	Offset-2 Stop Freq	2.4 MHz
	Offset-3 Stop Freq	4.0 MHz
	Offset-1 Reference Level	Auto
	Offset-2 Reference Level	Auto
	Offset-3 Reference Level	Auto
	Offset-1 RBW	30 kHz
	Offset-2 RBW	30 kHz
	Offset-3 RBW	30 kHz
	Offset-1 Sweep Time	676 ms
	Offset-2 Sweep Time	676 ms
Offset-3 Sweep Time	676 ms	

Table C-5 Standard parameters for Spectrum Emission Mask (Cont'd)

Standard	Parameter Name	Setting
TD-SCDMA Uplink Actual ($-53.5\text{dBm} \leq P$)	Offset-1 Auto Sweep Time Select	Normal
	Offset-2 Auto Sweep Time Select	Normal
	Offset-3 Auto Sweep Time Select	Normal
	Offset-1 Detection	RMS
	Offset-2 Detection	RMS
	Offset-3 Detection	RMS
	Offset-1 Trace Point	1001
	Offset-2 Trace Point	1001
	Offset-3 Trace Point	1001
	Offset-1 Integrate BW	Auto
	Offset-2 Integrate BW	Auto
	Offset-3 Integrate BW	Auto
	Offset-1 On/Off	On
	Offset-2 On/Off	On
	Offset-3 On/Off	On
	Limit-1 REL Start Level	-33.5 dB
	Limit-2 REL Start Level	-47.5 dB
	Limit-3 REL Start Level	-42.5 dB
	Limit-1 REL Stop Level	-47.5 dB
	Limit-2 REL Stop Level	-64.5 dB
	Limit-3 REL Stop Level	-42.5 dB
	Limit-1 Fail Logic	REL
	Limit-2 Fail Logic	REL
Limit-3 Fail Logic	REL	

Table C-5 Standard parameters for Spectrum Emission Mask (Cont'd)

Standard	Parameter Name	Setting
TD-SCDMA Uplink Actual ($-55\text{dBm} \leq P$)	Limit Side	Both
	Noise Cancel	Off
	Reference Mode	Channel
	Channel BW	1.6 MHz
	RBW	30 kHz
	Sweep Time Switch	Manual
	Sweep Time Freq. Domain	676 ms
	Auto Sweep Time Select	Normal
	Detection	RMS
	Trace Point	1001
	Filter Type	Rect
	Offset-1 Start Freq	815 kHz
	Offset-2 Start Freq	1.815 MHz
	Offset-3 Start Freq	2.4 MHz
	Offset-1 Stop Freq	1.815 MHz
	Offset-2 Stop Freq	2.4 MHz
	Offset-3 Stop Freq	4.0 MHz
	Offset-1 Reference Level	Auto
	Offset-2 Reference Level	Auto
	Offset-3 Reference Level	Auto
	Offset-1 RBW	30 kHz
	Offset-2 RBW	30 kHz
	Offset-3 RBW	30 kHz
	Offset-1 Sweep Time	676 ms
	Offset-2 Sweep Time	676 ms
Offset-3 Sweep Time	676 ms	

Table C-5 Standard parameters for Spectrum Emission Mask (Cont'd)

Standard	Parameter Name	Setting
TD-SCDMA Uplink Actual ($-55\text{dBm} \leq P$)	Offset-1 Auto Sweep Time Select	Normal
	Offset-2 Auto Sweep Time Select	Normal
	Offset-3 Auto Sweep Time Select	Normal
	Offset-1 Detection	RMS
	Offset-2 Detection	RMS
	Offset-3 Detection	RMS
	Offset-1 Trace Point	1001
	Offset-2 Trace Point	1001
	Offset-3 Trace Point	1001
	Offset-1 Integrate BW	Auto
	Offset-2 Integrate BW	Auto
	Offset-3 Integrate BW	Auto
	Offset-1 On/Off	On
	Offset-2 On/Off	On
	Offset-3 On/Off	On
	Limit-1 REL Start Level	-35.0 dB
	Limit-2 REL Start Level	-49.0 dB
	Limit-3 REL Start Level	-44.0 dB
	Limit-1 REL Stop Level	-49.0 dB
	Limit-2 REL Stop Level	-66.0 dB
	Limit-3 REL Stop Level	-44.0 dB
Limit-1 Fail Logic	REL	
Limit-2 Fail Logic	REL	
Limit-3 Fail Logic	REL	

Table C-5 Standard parameters for Spectrum Emission Mask (Cont'd)

Standard	Parameter Name	Setting
TD-SCDMA Downlink Fast (34dBm ≤ P)	Limit Side	Both
	Noise Cancel	Off
	Reference Mode	Channel
	Channel BW	1.6 MHz
	RBW	30 kHz
	Sweep Time	Auto
	Auto Sweep Time Select	Normal
	Detection	RMS
	Trace Point	1001
	Filter Type	Rect
	Offset-1 Start Freq	815 kHz
	Offset-2 Start Freq	1.015 MHz
	Offset-3 Start Freq	1.815 MHz
	Offset-4 Start Freq	2.3 MHz
	Offset-1 Stop Freq	1.015 MHz
	Offset-2 Stop Freq	1.815 MHz
	Offset-3 Stop Freq	2.3 MHz
	Offset-4 Stop Freq	4 MHz
	Offset-1 Reference Level	Auto
	Offset-2 Reference Level	Auto
	Offset-3 Reference Level	Auto
	Offset-4 Reference Level	Auto
	Offset-1 RBW	30 kHz
	Offset-2 RBW	30 kHz
	Offset-3 RBW	30 kHz
	Offset-4 RBW	30 kHz
	Offset-1 Sweep Time	Auto
	Offset-2 Sweep Time	Auto
Offset-3 Sweep Time	Auto	
Offset-4 Sweep Time	Auto	

Table C-5 Standard parameters for Spectrum Emission Mask (Cont'd)

Standard	Parameter Name	Setting
TD-SCDMA Downlink Fast (34dBm ≤ P)	Offset-1 Auto Sweep Time Select	Normal
	Offset-2 Auto Sweep Time Select	Normal
	Offset-3 Auto Sweep Time Select	Normal
	Offset-4 Auto Sweep Time Select	Normal
	Offset-1 Detection	RMS
	Offset-2 Detection	RMS
	Offset-3 Detection	RMS
	Offset-4 Detection	RMS
	Offset-1 Trace Point	1001
	Offset-2 Trace Point	1001
	Offset-3 Trace Point	1001
	Offset-4 Trace Point	1001
	Offset-1 Integrate BW	Auto
	Offset-2 Integrate BW	Auto
	Offset-3 Integrate BW	Auto
	Offset-4 Integrate BW	1 MHz
	Offset-1 On/Off	On
	Offset-2 On/Off	On
	Offset-3 On/Off	On
	Offset-4 On/Off	On
	Limit-1 ABS1 Start Level	-20.0 dBm
	Limit-2 ABS1 Start Level	-20.0 dBm
	Limit-3 ABS1 Start Level	-28.0 dBm
	Limit-4 ABS1 Start Level	-13.0 dBm
	Limit-1 ABS1 Stop Level	-20.0 dBm
	Limit-2 ABS1 Stop Level	-28.0 dBm
	Limit-3 ABS1 Stop Level	-28.0 dBm
	Limit-4 ABS1 Stop Level	-13.0 dBm
	Limit-1 Fail Logic	ABS1
	Limit-2 Fail Logic	ABS1
	Limit-3 Fail Logic	ABS1
	Limit-4 Fail Logic	ABS1

Table C-5 Standard parameters for Spectrum Emission Mask (Cont'd)

Standard	Parameter Name	Setting
TD-SCDMA Downlink Fast (26dBm ≤ P < 34dBm)	Limit Side	Both
	Noise Cancel	Off
	Reference Mode	Channel
	Channel BW	1.6 MHz
	RBW	30 kHz
	Sweep Time	Auto
	Auto Sweep Time Select	Normal
	Detection	RMS
	Trace Point	1001
	Filter Type	Rect
	Offset-1 Start Freq	815 kHz
	Offset-2 Start Freq	1.015 MHz
	Offset-3 Start Freq	1.815 MHz
	Offset-4 Start Freq	2.3 MHz
	Offset-1 Stop Freq	1.015 MHz
	Offset-2 Stop Freq	1.815 MHz
	Offset-3 Stop Freq	2.3 MHz
	Offset-4 Stop Freq	4 MHz
	Offset-1 Reference Level	Auto
	Offset-2 Reference Level	Auto
	Offset-3 Reference Level	Auto
	Offset-4 Reference Level	Auto
	Offset-1 RBW	30 kHz
	Offset-2 RBW	30 kHz
	Offset-3 RBW	30 kHz
	Offset-4 RBW	30 kHz
	Offset-1 Sweep Time	Auto
	Offset-2 Sweep Time	Auto
Offset-3 Sweep Time	Auto	
Offset-4 Sweep Time	Auto	

Table C-5 Standard parameters for Spectrum Emission Mask (Cont'd)

Standard	Parameter Name	Setting
TD-SCDMA Downlink Fast (26dBm ≤ P < 34dBm)	Offset-1 Auto Sweep Time Select	Normal
	Offset-2 Auto Sweep Time Select	Normal
	Offset-3 Auto Sweep Time Select	Normal
	Offset-4 Auto Sweep Time Select	Normal
	Offset-1 Detection	RMS
	Offset-2 Detection	RMS
	Offset-3 Detection	RMS
	Offset-4 Detection	RMS
	Offset-1 Trace Point	1001
	Offset-2 Trace Point	1001
	Offset-3 Trace Point	1001
	Offset-4 Trace Point	1001
	Offset-1 Integrate BW	Auto
	Offset-2 Integrate BW	Auto
	Offset-3 Integrate BW	Auto
	Offset-4 Integrate BW	1 MHz
	Offset-1 On/Off	On
	Offset-2 On/Off	On
	Offset-3 On/Off	On
	Offset-4 On/Off	On
	Limit-1 REL Start Level	-54.0 dB
	Limit-2 REL Start Level	-54.0 dB
	Limit-3 REL Start Level	-62.0 dB
	Limit-4 REL Start Level	-47.0 dB
	Limit-1 REL Stop Level	-54.0 dB
	Limit-2 REL Stop Level	-62.0 dB
	Limit-3 REL Stop Level	-62.0 dB
	Limit-4 REL Stop Level	-47.0 dB
	Limit-1 Fail Logic	REL
	Limit-2 Fail Logic	REL
	Limit-3 Fail Logic	REL
	Limit-4 Fail Logic	REL

Table C-5 Standard parameters for Spectrum Emission Mask (Cont'd)

Standard	Parameter Name	Setting
TD-SCDMA Downlink Fast (P < 26dBm)	Limit Side	Both
	Noise Cancel	Off
	Reference Mode	Channel
	Channel BW	1.6 MHz
	RBW	30 kHz
	Sweep Time	Auto
	Auto Sweep Time Select	Normal
	Detection	RMS
	Trace Point	1001
	Filter Type	Rect
	Offset-1 Start Freq	815 kHz
	Offset-2 Start Freq	1.015 MHz
	Offset-3 Start Freq	1.815 MHz
	Offset-4 Start Freq	2.3 MHz
	Offset-1 Stop Freq	1.015 MHz
	Offset-2 Stop Freq	1.815 MHz
	Offset-3 Stop Freq	2.3 MHz
	Offset-4 Stop Freq	4 MHz
	Offset-1 Reference Level	Auto
	Offset-2 Reference Level	Auto
	Offset-3 Reference Level	Auto
	Offset-4 Reference Level	Auto
	Offset-1 RBW	30 kHz
	Offset-2 RBW	30 kHz
	Offset-3 RBW	30 kHz
	Offset-4 RBW	30 kHz
	Offset-1 Sweep Time	Auto
	Offset-2 Sweep Time	Auto
Offset-3 Sweep Time	Auto	
Offset-4 Sweep Time	Auto	

Table C-5 Standard parameters for Spectrum Emission Mask (Cont'd)

Standard	Parameter Name	Setting
TD-SCDMA Downlink Fast (P < 26dBm)	Offset-1 Auto Sweep Time Select	Normal
	Offset-2 Auto Sweep Time Select	Normal
	Offset-3 Auto Sweep Time Select	Normal
	Offset-4 Auto Sweep Time Select	Normal
	Offset-1 Detection	RMS
	Offset-2 Detection	RMS
	Offset-3 Detection	RMS
	Offset-4 Detection	RMS
	Offset-1 Trace Point	1001
	Offset-2 Trace Point	1001
	Offset-3 Trace Point	1001
	Offset-4 Trace Point	1001
	Offset-1 Integrate BW	Auto
	Offset-2 Integrate BW	Auto
	Offset-3 Integrate BW	Auto
	Offset-4 Integrate BW	1 MHz
	Offset-1 On/Off	On
	Offset-2 On/Off	On
	Offset-3 On/Off	On
	Offset-4 On/Off	On
	Limit-1 ABS1 Start Level	-28.0 dBm
	Limit-2 ABS1 Start Level	-28.0 dBm
	Limit-3 ABS1 Start Level	-36.0 dBm
	Limit-4 ABS1 Start Level	-21.0 dBm
	Limit-1 ABS1 Stop Level	-28.0 dBm
	Limit-2 ABS1 Stop Level	-36.0 dBm
	Limit-3 ABS1 Stop Level	-36.0 dBm
	Limit-4 ABS1 Stop Level	-21.0 dBm
	Limit-1 Fail Logic	ABS1
	Limit-2 Fail Logic	ABS1
	Limit-3 Fail Logic	ABS1
	Limit-4 Fail Logic	ABS1

Table C-5 Standard parameters for Spectrum Emission Mask (Cont'd)

Standard	Parameter Name	Setting
TD-SCDMA Uplink Fast ($-53.5\text{dBm} \leq P$)	Limit Side	Both
	Noise Cancel	Off
	Reference Mode	Channel
	Channel BW	1.6 MHz
	RBW	30 kHz
	Sweep Time	Auto
	Auto Sweep Time Select	Normal
	Detection	RMS
	Trace Point	1001
	Filter Type	Rect
	Offset-1 Start Freq	815 kHz
	Offset-2 Start Freq	1.815 MHz
	Offset-3 Start Freq	2.4 MHz
	Offset-1 Stop Freq	1.815 MHz
	Offset-2 Stop Freq	2.4 MHz
	Offset-3 Stop Freq	4.0 MHz
	Offset-1 Reference Level	Auto
	Offset-2 Reference Level	Auto
	Offset-3 Reference Level	Auto
	Offset-1 RBW	30 kHz
	Offset-2 RBW	30 kHz
	Offset-3 RBW	30 kHz
	Offset-1 Sweep Time	Auto
Offset-2 Sweep Time	Auto	
Offset-3 Sweep Time	Auto	

Table C-5 Standard parameters for Spectrum Emission Mask (Cont'd)

Standard	Parameter Name	Setting
TD-SCDMA Uplink Fast ($-53.5\text{dBm} \leq P$)	Offset-1 Auto Sweep Time Select	Normal
	Offset-2 Auto Sweep Time Select	Normal
	Offset-3 Auto Sweep Time Select	Normal
	Offset-1 Detection	RMS
	Offset-2 Detection	RMS
	Offset-3 Detection	RMS
	Offset-1 Trace Point	1001
	Offset-2 Trace Point	1001
	Offset-3 Trace Point	1001
	Offset-1 Integrate BW	Auto
	Offset-2 Integrate BW	Auto
	Offset-3 Integrate BW	1 MHz
	Offset-1 On/Off	On
	Offset-2 On/Off	On
	Offset-3 On/Off	On
	Limit-1 REL Start Level	-33.5 dB
	Limit-2 REL Start Level	-47.5 dB
	Limit-3 REL Start Level	-42.5 dB
	Limit-1 REL Stop Level	-47.5 dB
	Limit-2 REL Stop Level	-64.5 dB
	Limit-3 REL Stop Level	-42.5 dB
	Limit-1 Fail Logic	REL
	Limit-2 Fail Logic	REL
Limit-3 Fail Logic	REL	

Table C-5 Standard parameters for Spectrum Emission Mask (Cont'd)

Standard	Parameter Name	Setting
TD-SCDMA Uplink Fast (-55dBm ≤ P)	Limit Side	Both
	Noise Cancel	Off
	Reference Mode	Channel
	Channel BW	1.6 MHz
	RBW	30 kHz
	Sweep Time	Auto
	Auto Sweep Time Select	Normal
	Detection	RMS
	Trace Point	1001
	Filter Type	Rect
	Offset-1 Start Freq	815 kHz
	Offset-2 Start Freq	1.815 MHz
	Offset-3 Start Freq	2.4 MHz
	Offset-1 Stop Freq	1.815 MHz
	Offset-2 Stop Freq	2.4 MHz
	Offset-3 Stop Freq	4.0 MHz
	Offset-1 Reference Level	Auto
	Offset-2 Reference Level	Auto
	Offset-3 Reference Level	Auto
	Offset-1 RBW	30 kHz
	Offset-2 RBW	30 kHz
	Offset-3 RBW	30 kHz
	Offset-1 Sweep Time	Auto
Offset-2 Sweep Time	Auto	
Offset-3 Sweep Time	Auto	

Table C-5 Standard parameters for Spectrum Emission Mask (Cont'd)

Standard	Parameter Name	Setting
TD-SCDMA Uplink Fast (-55dBm ≤ P)	Offset-1 Auto Sweep Time Select	Normal
	Offset-2 Auto Sweep Time Select	Normal
	Offset-3 Auto Sweep Time Select	Normal
	Offset-1 Detection	RMS
	Offset-2 Detection	RMS
	Offset-3 Detection	RMS
	Offset-1 Trace Point	1001
	Offset-2 Trace Point	1001
	Offset-3 Trace Point	1001
	Offset-1 Integrate BW	Auto
	Offset-2 Integrate BW	Auto
	Offset-3 Integrate BW	1 MHz
	Offset-1 On/Off	On
	Offset-2 On/Off	On
	Offset-3 On/Off	On
	Limit-1 REL Start Level	-35.0 dB
	Limit-2 REL Start Level	-49.0 dB
	Limit-3 REL Start Level	-44.0 dB
	Limit-1 REL Stop Level	-49.0 dB
	Limit-2 REL Stop Level	-66.0 dB
	Limit-3 REL Stop Level	-44.0 dB
	Limit-1 Fail Logic	REL
	Limit-2 Fail Logic	REL
Limit-3 Fail Logic	REL	

XG-PHS

Table C-5 Standard parameters for Spectrum Emission Mask (Cont'd)

Standard	Parameter Name	Setting
XG-PHS 10MHz BW BS	Frequency Span	50 MHz
	RBW	30 kHz
	Reference Mode	Channel
	Reference Channel Bandwidth	10 MHz
	Reference Sweep Time Switch	Auto
	Reference Auto Sweep Time Select	Normal
	Reference Detection	RMS
	Offset-1 On/Off	Off
	Offset-1 Start Freq-1	5.2 MHz
	Offset-1 Stop Freq-1	14.8 MHz
	Offset-1 RBW Value	30 kHz
	Offset-1 Sweep Time Switch	Manual
	Offset-1 Sweep Time Value	5100 ms
	Offset-1 Auto Sweep Time Select	Normal
	Offset-1 Integrate BW Switch	Manual
	Offset-1 Integrate BW	1 MHz
	Limit-1 ABS1 Start Level	-10 dBm
	Limit-1 ABS1 Stop Level	-10 dBm
	Limit-1 Fail Logic	ABS1
	Offset-1 Detection	RMS
	Offset-2 On/Off	On
	Offset-2 Start Freq-1	15 MHz
	Offset-2 Stop Freq-1	25 MHz
	Offset-2 RBW Value	1 MHz
	Offset-2 Sweep Time Switch	Manual
	Offset-2 Sweep Time Value	500 ms
	Offset-2 Integrate BW Switch	AUTO
	Limit-2 ABS1 Start Level	-30 dBm
Limit-2 ABS1 Stop Level	-30 dBm	
Limit-2 Fail Logic	ABS1	
Offset-2 Detection	Positive	

Note:

Burst time ratio is not considered for the XG-PHS 10 MHz BW BS settings.

Table C-5 Standard parameters for Spectrum Emission Mask (Cont'd)

Standard	Parameter Name	Setting
XG-PHS 10MHz BW UE	Frequency Span	50 MHz
	RBW	30 kHz
	Reference Mode	Channel
	Reference Channel Bandwidth	10 MHz
	Reference Sweep Time Switch	Auto
	Reference Auto Sweep Time Select	Normal
	Reference Detection	RMS
	Offset-1 On/Off	Off
	Offset-1 Start Freq-1	5.2 MHz
	Offset-1 Stop Freq-1	14.8 MHz
	Offset-1 RBW Value	30 kHz
	Offset-1 Sweep Time Switch	Manual
	Offset-1 Sweep Time Value	5100 ms
	Offset-1 Auto Sweep Time Select	Normal
	Offset-1 Integrate BW Switch	Manual
	Offset-1 Integrate BW	1 MHz
	Limit-1 ABS1 Start Level	-10 dBm
	Limit-1 ABS1 Stop Level	-10 dBm
	Limit-1 Fail Logic	ABS1
	Offset-1 Detection	RMS
	Offset-2 On/Off	On
	Offset-2 Start Freq-1	15 MHz
	Offset-2 Stop Freq-1	20 MHz
	Offset-2 RBW Value	1 MHz
	Offset-2 Sweep Time Switch	Manual
	Offset-2 Sweep Time Value	250 ms
	Offset-2 Integrate BW Switch	AUTO
	Limit-2 ABS1 Start Level	-25 dBm
Limit-2 ABS1 Stop Level	-30 dBm	

Table C-5 Standard parameters for Spectrum Emission Mask (Cont'd)

Standard	Parameter Name	Setting
XG-PHS 10MHz BW UE	Limit-2 Fail Logic	ABS1
	Offset-2 Detection	Positive
	Offset-3 On/Off	On
	Offset-3 Start Freq-1	20 MHz
	Offset-3 Stop Freq-1	25 MHz
	Offset-3 RBW Value	1 MHz
	Offset-3 Sweep Time Switch	Manual
	Offset-3 Sweep Time Value	250 ms
	Offset-3 Integrate BW Switch	AUTO
	Limit-3 ABS1 Start Level	-30 dBm
	Limit-3 ABS1 Stop Level	-30 dBm
	Limit-3 Fail Logic	ABS1
Offset-3 Detection	Positive	

Note:

Burst time ratio is not considered for the XG-PHS 10 MHz BW UE settings.

CDMA2000

Table C-5 Standard parameters for Spectrum Emission Mask (Cont'd)

Standard	Parameter Name	Setting
CDMA2000 Forward Link Band Class 0,2,5,7,9,10 (Pout < 28dBm)	Limit Side	Both
	Noise Cancel	Off
	Reference Mode	Channel
	Channel BW	1.23 MHz
	RBW	30 kHz
	VBW	Auto
	Sweep Time	Auto
	Auto Sweep Time Select	Normal
	Detection	RMS
	Trace Point	101
	Filter Type	Rect
	Offset-1 Start Freq	765 kHz
	Offset-2 Start Freq	1.995 MHz
	Offset-3 Start Freq	3.2531 MHz
	Offset-4 Start Freq	4.0005 MHz
	Offset-5 Start Freq	6.405 MHz
	Offset-1 Stop Freq	1.995 MHz
	Offset-2 Stop Freq	4.015 MHz
	Offset-3 Stop Freq	4.0031 MHz
	Offset-4 Stop Freq	6.4005 MHz
	Offset-5 Stop Freq	16.005 MHz
	Offset-1 Reference Level	Auto
	Offset-2 Reference Level	Auto
	Offset-3 Reference Level	Auto
	Offset-4 Reference Level	Auto
	Offset-5 Reference Level	Auto
	Offset-1 RBW	30 kHz
	Offset-2 RBW	30 kHz
Offset-3 RBW	100 Hz	
Offset-4 RBW	1 kHz	
Offset-5 RBW	10 kHz	

Table C-5 Standard parameters for Spectrum Emission Mask (Cont'd)

Standard	Parameter Name	Setting
CDMA2000 Forward Link Band Class 0,2,5,7,9,10 (Pout < 28dBm)	Offset-1 Sweep Time	Auto
	Offset-2 Sweep Time	Auto
	Offset-3 Sweep Time	Auto
	Offset-4 Sweep Time	Auto
	Offset-5 Sweep Time	Auto
	Offset-1 Auto Sweep Time Select	Normal
	Offset-2 Auto Sweep Time Select	Normal
	Offset-3 Auto Sweep Time Select	Normal
	Offset-4 Auto Sweep Time Select	Normal
	Offset-5 Auto Sweep Time Select	Normal
	Offset-1 Detection	RMS
	Offset-2 Detection	RMS
	Offset-3 Detection	RMS
	Offset-4 Detection	RMS
	Offset-5 Detection	RMS
	Offset-1 Trace Point	101
	Offset-2 Trace Point	101
	Offset-3 Trace Point	10001
	Offset-4 Trace Point	5001
	Offset-5 Trace Point	1001
	Offset-1 Integrate BW	Auto
	Offset-2 Integrate BW	Auto
	Offset-3 Integrate BW	6.25 kHz
	Offset-4 Integrate BW	Auto
	Offset-5 Integrate BW	Auto
	Offset-1 On/Off	On
	Offset-2 On/Off	On
	Offset-3 On/Off	Off
	Offset-4 On/Off	Off
	Offset-5 On/Off	Off
Offset-6 On/Off	Off	

Table C-5 Standard parameters for Spectrum Emission Mask (Cont'd)

Standard	Parameter Name	Setting
CDMA2000 Forward Link Band Class 0,2,5,7,9,10 (Pout < 28dBm)	Limit-1 ABS1 Start Level	-13.0 dBm
	Limit-2 ABS1 Start Level	-13.0 dBm
	Limit-3 ABS1 Start Level	-46.0 dBm
	Limit-4 ABS1 Start Level	-36.0 dBm
	Limit-5 ABS1 Start Level	-36.0 dBm
	Limit-1 ABS1 Stop Level	-13.0 dBm
	Limit-2 ABS1 Stop Level	-13.0 dBm
	Limit-3 ABS1 Stop Level	-46.0 dBm
	Limit-4 ABS1 Stop Level	-36.0 dBm
	Limit-5 ABS1 Stop Level	-36.0 dBm
	Limit-1 ABS2 Start Level	-27.0 dBm
	Limit-2 ABS2 Start Level	-27.0 dBm
	Limit-3 ABS2 Start Level	-27.0 dBm
	Limit-4 ABS2 Start Level	-27.0 dBm
	Limit-5 ABS2 Start Level	-27.0 dBm
	Limit-1 ABS2 Stop Level	-27.0 dBm
	Limit-2 ABS2 Stop Level	-27.0 dBm
	Limit-3 ABS2 Stop Level	-27.0 dBm
	Limit-4 ABS2 Stop Level	-27.0 dBm
	Limit-5 ABS2 Stop Level	-27.0 dBm
	Limit-1 REL Start Level	-45.0 dB
	Limit-2 REL Start Level	-55.0 dB
	Limit-3 REL Start Level	-55.0 dB
	Limit-4 REL Start Level	-55.0 dB
	Limit-5 REL Start Level	-55.0 dB
	Limit-1 REL Stop Level	-45.0 dB
	Limit-2 REL Stop Level	-55.0 dB
	Limit-3 REL Stop Level	-55.0 dB
	Limit-4 REL Stop Level	-55.0 dB
	Limit-5 REL Stop Level	-55.0 dB
	Limit-1 Fail Logic	REL
	Limit-2 Fail Logic	REL
Limit-3 Fail Logic	ABS1	
Limit-4 Fail Logic	ABS1	
Limit-5 Fail Logic	ABS1	
Limit-6 Fail Logic	Off	

Table C-5 Standard parameters for Spectrum Emission Mask (Cont'd)

Standard	Parameter Name	Setting
CDMA2000 Forward Link Band Class 0,2,5,7,9,10 (28dBm ≤ Pout < 33dBm)	Limit Side	Both
	Noise Cancel	Off
	Reference Mode	Channel
	Channel BW	1.23 MHz
	RBW	30 kHz
	VBW	Auto
	Sweep Time	Auto
	Auto Sweep Time Select	Normal
	Detection	RMS
	Trace Point	101
	Filter Type	Rect
	Offset-1 Start Freq	765 kHz
	Offset-2 Start Freq	1.995 MHz
	Offset-3 Start Freq	3.2531 MHz
	Offset-4 Start Freq	4.0005 MHz
	Offset-5 Start Freq	6.405 MHz
	Offset-1 Stop Freq	1.995 MHz
	Offset-2 Stop Freq	4.015 MHz
	Offset-3 Stop Freq	4.0031 MHz
	Offset-4 Stop Freq	6.4005 MHz
	Offset-5 Stop Freq	16.005 MHz
	Offset-1 Reference Level	Auto
	Offset-2 Reference Level	Auto
	Offset-3 Reference Level	Auto
	Offset-4 Reference Level	Auto
	Offset-5 Reference Level	Auto
	Offset-1 RBW	30 kHz
	Offset-2 RBW	30 kHz
	Offset-3 RBW	100 Hz
	Offset-4 RBW	1 kHz
	Offset-5 RBW	10 kHz
	Offset-1 Sweep Time	Auto
Offset-2 Sweep Time	Auto	
Offset-3 Sweep Time	Auto	
Offset-4 Sweep Time	Auto	
Offset-5 Sweep Time	Auto	

Table C-5 Standard parameters for Spectrum Emission Mask (Cont'd)

Standard	Parameter Name	Setting
CDMA2000 Forward Link Band Class 0,2,5,7,9,10 (28dBm ≤ Pout < 33dBm)	Offset-1 Auto Sweep Time Select	Normal
	Offset-2 Auto Sweep Time Select	Normal
	Offset-3 Auto Sweep Time Select	Normal
	Offset-4 Auto Sweep Time Select	Normal
	Offset-5 Auto Sweep Time Select	Normal
	Offset-1 Detection	RMS
	Offset-2 Detection	RMS
	Offset-3 Detection	RMS
	Offset-4 Detection	RMS
	Offset-5 Detection	RMS
	Offset-1 Trace Point	101
	Offset-2 Trace Point	101
	Offset-3 Trace Point	10001
	Offset-4 Trace Point	5001
	Offset-5 Trace Point	1001
	Offset-1 Integrate BW	Auto
	Offset-2 Integrate BW	Auto
	Offset-3 Integrate BW	6.25 kHz
	Offset-4 Integrate BW	Auto
	Offset-5 Integrate BW	Auto
	Offset-1 On/Off	On
	Offset-2 On/Off	On
	Offset-3 On/Off	Off
	Offset-4 On/Off	Off
Offset-5 On/Off	Off	
Offset-6 On/Off	Off	

Table C-5 Standard parameters for Spectrum Emission Mask (Cont'd)

Standard	Parameter Name	Setting
CDMA2000 Forward Link Band Class 0,2,5,7,9,10 (28dBm ≤ Pout < 33dBm)	Limit-1 ABS1 Start Level	-13.0 dBm
	Limit-2 ABS1 Start Level	-27.0 dBm
	Limit-3 ABS1 Start Level	-46.0 dBm
	Limit-4 ABS1 Start Level	-36.0 dBm
	Limit-5 ABS1 Start Level	-36.0 dBm
	Limit-1 ABS1 Stop Level	-13.0 dBm
	Limit-2 ABS1 Stop Level	-27.0 dBm
	Limit-3 ABS1 Stop Level	-46.0 dBm
	Limit-4 ABS1 Stop Level	-36.0 dBm
	Limit-5 ABS1 Stop Level	-36.0 dBm
	Limit-1 ABS2 Start Level	-27.0 dBm
	Limit-2 ABS2 Start Level	-27.0 dBm
	Limit-3 ABS2 Start Level	-27.0 dBm
	Limit-4 ABS2 Start Level	-27.0 dBm
	Limit-5 ABS2 Start Level	-27.0 dBm
	Limit-1 ABS2 Stop Level	-27.0 dBm
	Limit-2 ABS2 Stop Level	-27.0 dBm
	Limit-3 ABS2 Stop Level	-27.0 dBm
	Limit-4 ABS2 Stop Level	-27.0 dBm
	Limit-5 ABS2 Stop Level	-27.0 dBm
	Limit-1 REL Start Level	-45.0 dB
	Limit-2 REL Start Level	-55.0 dB
	Limit-3 REL Start Level	-55.0 dB
	Limit-4 REL Start Level	-55.0 dB
	Limit-5 REL Start Level	-55.0 dB
	Limit-1 REL Stop Level	-45.0 dB
	Limit-2 REL Stop Level	-55.0 dB
	Limit-3 REL Stop Level	-55.0 dB
	Limit-4 REL Stop Level	-55.0 dB
	Limit-5 REL Stop Level	-55.0 dB
Limit-1 Fail Logic	REL	
Limit-2 Fail Logic	ABS1	
Limit-3 Fail Logic	ABS1	
Limit-4 Fail Logic	ABS1	
Limit-5 Fail Logic	ABS1	
Limit-6 Fail Logic	Off	

Table C-5 Standard parameters for Spectrum Emission Mask (Cont'd)

Standard	Parameter Name	Setting
CDMA2000 Forward Link Band Class 0,2,5,7,9,10 (Pout ≥ 33dBm)	Limit Side	Both
	Noise Cancel	Off
	Reference Mode	Channel
	Channel BW	1.23 MHz
	RBW	30 kHz
	VBW	Auto
	Sweep Time	Auto
	Auto Sweep Time Select	Normal
	Detection	RMS
	Trace Point	101
	Filter Type	Rect
	Offset-1 Start Freq	765 kHz
	Offset-2 Start Freq	1.995 MHz
	Offset-3 Start Freq	3.2531 MHz
	Offset-4 Start Freq	4.0005 MHz
	Offset-5 Start Freq	6.405 MHz
	Offset-1 Stop Freq	1.995 MHz
	Offset-2 Stop Freq	4.015 MHz
	Offset-3 Stop Freq	4.0031 MHz
	Offset-4 Stop Freq	6.4005 MHz
	Offset-5 Stop Freq	16.005 MHz
	Offset-1 Reference Level	Auto
	Offset-2 Reference Level	Auto
	Offset-3 Reference Level	Auto
	Offset-4 Reference Level	Auto
	Offset-5 Reference Level	Auto
	Offset-1 RBW	30 kHz
	Offset-2 RBW	30 kHz
	Offset-3 RBW	100 Hz
	Offset-4 RBW	1 kHz
	Offset-5 RBW	10 kHz
	Offset-1 Sweep Time	Auto
Offset-2 Sweep Time	Auto	
Offset-3 Sweep Time	Auto	
Offset-4 Sweep Time	Auto	
Offset-5 Sweep Time	Auto	

Table C-5 Standard parameters for Spectrum Emission Mask (Cont'd)

Standard	Parameter Name	Setting
CDMA2000 Forward Link Band Class 0,2,5,7,9,10 (Pout ≥ 33dBm)	Offset-1 Auto Sweep Time Select	Normal
	Offset-2 Auto Sweep Time Select	Normal
	Offset-3 Auto Sweep Time Select	Normal
	Offset-4 Auto Sweep Time Select	Normal
	Offset-5 Auto Sweep Time Select	Normal
	Offset-1 Detection	RMS
	Offset-2 Detection	RMS
	Offset-3 Detection	RMS
	Offset-4 Detection	RMS
	Offset-5 Detection	RMS
	Offset-1 Trace Point	101
	Offset-2 Trace Point	101
	Offset-3 Trace Point	10001
	Offset-4 Trace Point	5001
	Offset-5 Trace Point	1001
	Offset-1 Integrate BW	Auto
	Offset-2 Integrate BW	Auto
	Offset-3 Integrate BW	6.25 kHz
	Offset-4 Integrate BW	Auto
	Offset-5 Integrate BW	Auto
	Offset-1 On/Off	On
	Offset-2 On/Off	On
	Offset-3 On/Off	Off
	Offset-4 On/Off	Off
	Offset-5 On/Off	Off
	Offset-6 On/Off	Off

Table C-5 Standard parameters for Spectrum Emission Mask (Cont'd)

Standard	Parameter Name	Setting
CDMA2000 Forward Link Band Class 0,2,5,7,9,10 (Pout ≥ 33dBm)	Limit-1 ABS1 Start Level	-13.0 dBm
	Limit-2 ABS1 Start Level	-13.0 dBm
	Limit-3 ABS1 Start Level	-46.0 dBm
	Limit-4 ABS1 Start Level	-36.0 dBm
	Limit-5 ABS1 Start Level	-36.0 dBm
	Limit-1 ABS1 Stop Level	-13.0 dBm
	Limit-2 ABS1 Stop Level	-13.0 dBm
	Limit-3 ABS1 Stop Level	-46.0 dBm
	Limit-4 ABS1 Stop Level	-36.0 dBm
	Limit-5 ABS1 Stop Level	-36.0 dBm
	Limit-1 ABS2 Start Level	-27.0 dBm
	Limit-2 ABS2 Start Level	-27.0 dBm
	Limit-3 ABS2 Start Level	-27.0 dBm
	Limit-4 ABS2 Start Level	-27.0 dBm
	Limit-5 ABS2 Start Level	-27.0 dBm
	Limit-1 ABS2 Stop Level	-27.0 dBm
	Limit-2 ABS2 Stop Level	-27.0 dBm
	Limit-3 ABS2 Stop Level	-27.0 dBm
	Limit-4 ABS2 Stop Level	-27.0 dBm
	Limit-5 ABS2 Stop Level	-27.0 dBm
	Limit-1 REL Start Level	-45.0 dB
	Limit-2 REL Start Level	-60.0 dB
	Limit-3 REL Start Level	-55.0 dB
	Limit-4 REL Start Level	-55.0 dB
	Limit-5 REL Start Level	-55.0 dB
	Limit-1 REL Stop Level	-45.0 dB
	Limit-2 REL Stop Level	-60.0 dB
	Limit-3 REL Stop Level	-55.0 dB
	Limit-4 REL Stop Level	-55.0 dB
	Limit-5 REL Stop Level	-55.0 dB
Limit-1 Fail Logic	REL	
Limit-2 Fail Logic	REL	
Limit-3 Fail Logic	ABS1	
Limit-4 Fail Logic	ABS1	
Limit-5 Fail Logic	ABS1	
Limit-6 Fail Logic	Off	

Table C-5 Standard parameters for Spectrum Emission Mask (Cont'd)

Standard	Parameter Name	Setting
CDMA2000 Forward Link Band Class 1,4,8,14,15 (Pout < 28dBm)	Limit Side	Both
	Noise Cancel	Off
	Reference Mode	Channel
	Channel BW	1.23 MHz
	RBW	30 kHz
	VBW	Auto
	Sweep Time	Auto
	Auto Sweep Time Select	Normal
	Detection	RMS
	Trace Point	101
	Filter Type	Rect
	Offset-1 Start Freq	900 kHz
	Offset-2 Start Freq	1.265 MHz
	Offset-3 Start Freq	1.995 MHz
	Offset-4 Start Freq	2.75 MHz
	Offset-5 Start Freq	1.265 MHz
	Offset-6 Start Freq	4.015 MHz
	Offset-1 Stop Freq	1.265 MHz
	Offset-2 Stop Freq	1.995 MHz
	Offset-3 Stop Freq	2.265 MHz
	Offset-4 Stop Freq	4.5 MHz
	Offset-5 Stop Freq	2.265 MHz
	Offset-6 Stop Freq	16.015 MHz
	Offset-1 Reference Level	Auto
	Offset-2 Reference Level	Auto
	Offset-3 Reference Level	Auto
	Offset-4 Reference Level	Auto
	Offset-5 Reference Level	Auto
	Offset-6 Reference Level	Auto
	Offset-1 RBW	30 kHz
	Offset-2 RBW	30 kHz
	Offset-3 RBW	30 kHz
Offset-4 RBW	1 MHz	
Offset-5 RBW	30 kHz	
Offset-6 RBW	30 kHz	

Table C-5 Standard parameters for Spectrum Emission Mask (Cont'd)

Standard	Parameter Name	Setting
CDMA2000 Forward Link Band Class 1,4,8,14,15 (Pout < 28dBm)	Offset-1 Sweep Time	Auto
	Offset-2 Sweep Time	Auto
	Offset-3 Sweep Time	Auto
	Offset-4 Sweep Time	Auto
	Offset-5 Sweep Time	Auto
	Offset-6 Sweep Time	Auto
	Offset-1 Auto Sweep Time Select	Normal
	Offset-2 Auto Sweep Time Select	Normal
	Offset-3 Auto Sweep Time Select	Normal
	Offset-4 Auto Sweep Time Select	Normal
	Offset-5 Auto Sweep Time Select	Normal
	Offset-6 Auto Sweep Time Select	Normal
	Offset-1 Detection	RMS
	Offset-2 Detection	RMS
	Offset-3 Detection	RMS
	Offset-4 Detection	RMS
	Offset-5 Detection	RMS
	Offset-6 Detection	RMS
	Offset-1 Trace Point	101
	Offset-2 Trace Point	101
	Offset-3 Trace Point	101
	Offset-4 Trace Point	101
	Offset-5 Trace Point	101
	Offset-6 Trace Point	501
	Offset-1 Integrate BW	Auto
	Offset-2 Integrate BW	Auto
	Offset-3 Integrate BW	Auto
	Offset-4 Integrate BW	Auto
	Offset-5 Integrate BW	Auto
	Offset-6 Integrate BW	Auto

Table C-5 Standard parameters for Spectrum Emission Mask (Cont'd)

Standard	Parameter Name	Setting
CDMA2000 Forward Link Band Class 1,4,8,14,15 (Pout < 28dBm)	Offset-1 On/Off	On
	Offset-2 On/Off	On
	Offset-3 On/Off	On
	Offset-4 On/Off	On
	Offset-5 On/Off	Off
	Offset-6 On/Off	Off
	Limit-1 ABS1 Start Level	-13.0 dBm
	Limit-2 ABS1 Start Level	-9.0 dBm
	Limit-3 ABS1 Start Level	-9.0 dBm
	Limit-4 ABS1 Start Level	-13.0 dBm
	Limit-5 ABS1 Start Level	-9.0 dBm
	Limit-6 ABS1 Start Level	-30.0 dBm
	Limit-1 ABS1 Stop Level	-13.0 dBm
	Limit-2 ABS1 Stop Level	-9.0 dBm
	Limit-3 ABS1 Stop Level	-9.0 dBm
	Limit-4 ABS1 Stop Level	-13.0 dBm
	Limit-5 ABS1 Stop Level	-9.0 dBm
	Limit-6 ABS1 Stop Level	-30.0 dBm
	Limit-1 ABS2 Start Level	-27.0 dBm
	Limit-2 ABS2 Start Level	-27.0 dBm
	Limit-3 ABS2 Start Level	-22.0 dBm
	Limit-4 ABS2 Start Level	-27.0 dBm
	Limit-5 ABS2 Start Level	-27.0 dBm
	Limit-6 ABS2 Start Level	-27.0 dBm
	Limit-1 ABS2 Stop Level	-27.0 dBm
	Limit-2 ABS2 Stop Level	-27.0 dBm
	Limit-3 ABS2 Stop Level	-22.0 dBm
	Limit-4 ABS2 Stop Level	-27.0 dBm
	Limit-5 ABS2 Stop Level	-27.0 dBm
	Limit-6 ABS2 Stop Level	-27.0 dBm

Table C-5 Standard parameters for Spectrum Emission Mask (Cont'd)

Standard	Parameter Name	Setting
CDMA2000 Forward Link Band Class 1,4,8,14,15 (Pout < 28dBm)	Limit-1 REL Start Level	-45.0 dB
	Limit-2 REL Start Level	-45.0 dB
	Limit-3 REL Start Level	-50.0 dB
	Limit-4 REL Start Level	-45.0 dB
	Limit-5 REL Start Level	-45.0 dB
	Limit-6 REL Start Level	-45.0 dB
	Limit-1 REL Stop Level	-45.0 dB
	Limit-2 REL Stop Level	-45.0 dB
	Limit-3 REL Stop Level	-50.0 dB
	Limit-4 REL Stop Level	-45.0 dB
	Limit-5 REL Stop Level	-45.0 dB
	Limit-6 REL Stop Level	-45.0 dB
	Limit-1 Fail Logic	REL
	Limit-2 Fail Logic	ABS1 and REL
	Limit-3 Fail Logic	REL
	Limit-4 Fail Logic	ABS1
	Limit-5 Fail Logic	ABS1
	Limit-6 Fail Logic	ABS1

Table C-5 Standard parameters for Spectrum Emission Mask (Cont'd)

Standard	Parameter Name	Setting
CDMA2000 Forward Link Band Class 1,4,8,14,15 (28dBm ≤ Pout < 33dBm)	Limit Side	Both
	Noise Cancel	Off
	Reference Mode	Channel
	Channel BW	1.23 MHz
	RBW	30 kHz
	VBW	Auto
	Sweep Time	Auto
	Auto Sweep Time Select	Normal
	Detection	RMS
	Trace Point	101
	Filter Type	Rect
	Offset-1 Start Freq	900 kHz
	Offset-2 Start Freq	1.265 MHz
	Offset-3 Start Freq	1.995 MHz
	Offset-4 Start Freq	2.75 MHz
	Offset-5 Start Freq	1.265 MHz
	Offset-6 Start Freq	4.015 MHz
	Offset-1 Stop Freq	1.265 MHz
	Offset-2 Stop Freq	1.995 MHz
	Offset-3 Stop Freq	2.265 MHz
	Offset-4 Stop Freq	4.5 MHz
	Offset-5 Stop Freq	2.265 MHz
	Offset-6 Stop Freq	16.015 MHz
	Offset-1 Reference Level	Auto
	Offset-2 Reference Level	Auto
	Offset-3 Reference Level	Auto
	Offset-4 Reference Level	Auto
	Offset-5 Reference Level	Auto
	Offset-6 Reference Level	Auto
	Offset-1 RBW	30 kHz
	Offset-2 RBW	30 kHz
	Offset-3 RBW	30 kHz
Offset-4 RBW	1 MHz	
Offset-5 RBW	30 kHz	
Offset-6 RBW	30 kHz	

Table C-5 Standard parameters for Spectrum Emission Mask (Cont'd)

Standard	Parameter Name	Setting
CDMA2000 Forward Link Band Class 1,4,8,14,15 (28dBm ≤ Pout < 33dBm)	Offset-1 Sweep Time	Auto
	Offset-2 Sweep Time	Auto
	Offset-3 Sweep Time	Auto
	Offset-4 Sweep Time	Auto
	Offset-5 Sweep Time	Auto
	Offset-6 Sweep Time	Auto
	Offset-1 Auto Sweep Time Select	Normal
	Offset-2 Auto Sweep Time Select	Normal
	Offset-3 Auto Sweep Time Select	Normal
	Offset-4 Auto Sweep Time Select	Normal
	Offset-5 Auto Sweep Time Select	Normal
	Offset-6 Auto Sweep Time Select	Normal
	Offset-1 Detection	RMS
	Offset-2 Detection	RMS
	Offset-3 Detection	RMS
	Offset-4 Detection	RMS
	Offset-5 Detection	RMS
	Offset-6 Detection	RMS
	Offset-1 Trace Point	101
	Offset-2 Trace Point	101
	Offset-3 Trace Point	101
	Offset-4 Trace Point	101
	Offset-5 Trace Point	101
	Offset-6 Trace Point	501
	Offset-1 Integrate BW	Auto
	Offset-2 Integrate BW	Auto
	Offset-3 Integrate BW	Auto
	Offset-4 Integrate BW	Auto
Offset-5 Integrate BW	Auto	
Offset-6 Integrate BW	Auto	

Table C-5 Standard parameters for Spectrum Emission Mask (Cont'd)

Standard	Parameter Name	Setting
CDMA2000 Forward Link Band Class 1,4,8,14,15 (28dBm ≤ Pout < 33dBm)	Offset-1 On/Off	On
	Offset-2 On/Off	On
	Offset-3 On/Off	On
	Offset-4 On/Off	On
	Offset-5 On/Off	Off
	Offset-6 On/Off	Off
	Limit-1 ABS1 Start Level	-13.0 dBm
	Limit-2 ABS1 Start Level	-9.0 dBm
	Limit-3 ABS1 Start Level	-22.0 dBm
	Limit-4 ABS1 Start Level	-13.0 dBm
	Limit-5 ABS1 Start Level	-9.0 dBm
	Limit-6 ABS1 Start Level	-30.0 dBm
	Limit-1 ABS1 Stop Level	-13.0 dBm
	Limit-2 ABS1 Stop Level	-9.0 dBm
	Limit-3 ABS1 Stop Level	-22.0 dBm
	Limit-4 ABS1 Stop Level	-13.0 dBm
	Limit-5 ABS1 Stop Level	-9.0 dBm
	Limit-6 ABS1 Stop Level	-30.0 dBm
	Limit-1 ABS2 Start Level	-27.0 dBm
	Limit-2 ABS2 Start Level	-27.0 dBm
	Limit-3 ABS2 Start Level	-9.0 dBm
	Limit-4 ABS2 Start Level	-27.0 dBm
	Limit-5 ABS2 Start Level	-27.0 dBm
	Limit-6 ABS2 Start Level	-27.0 dBm
	Limit-1 ABS2 Stop Level	-27.0 dBm
	Limit-2 ABS2 Stop Level	-27.0 dBm
	Limit-3 ABS2 Stop Level	-9.0 dBm
	Limit-4 ABS2 Stop Level	-27.0 dBm
	Limit-5 ABS2 Stop Level	-27.0 dBm
	Limit-6 ABS2 Stop Level	-27.0 dBm

Table C-5 Standard parameters for Spectrum Emission Mask (Cont'd)

Standard	Parameter Name	Setting
CDMA2000 Forward Link Band Class 1,4,8,14,15 (28dBm ≤ Pout < 33dBm)	Limit-1 REL Start Level	-45.0 dB
	Limit-2 REL Start Level	-45.0 dB
	Limit-3 REL Start Level	-50.0 dB
	Limit-4 REL Start Level	-45.0 dB
	Limit-5 REL Start Level	-45.0 dB
	Limit-6 REL Start Level	-45.0 dB
	Limit-1 REL Stop Level	-45.0 dB
	Limit-2 REL Stop Level	-45.0 dB
	Limit-3 REL Stop Level	-50.0 dB
	Limit-4 REL Stop Level	-45.0 dB
	Limit-5 REL Stop Level	-45.0 dB
	Limit-6 REL Stop Level	-45.0 dB
	Limit-1 Fail Logic	REL
	Limit-2 Fail Logic	ABS1 and REL
	Limit-3 Fail Logic	ABS1
	Limit-4 Fail Logic	ABS1
	Limit-5 Fail Logic	ABS1
	Limit-6 Fail Logic	ABS1

Table C-5 Standard parameters for Spectrum Emission Mask (Cont'd)

Standard	Parameter Name	Setting
CDMA2000 Forward Link Band Class 1,4,8,14,15 (Pout ≥ 33dBm)	Limit Side	Both
	Noise Cancel	Off
	Reference Mode	Channel
	Channel BW	1.23 MHz
	RBW	30 kHz
	VBW	Auto
	Sweep Time	Auto
	Auto Sweep Time Select	Normal
	Detection	RMS
	Trace Point	101
	Filter Type	Rect
	Offset-1 Start Freq	900 kHz
	Offset-2 Start Freq	1.265 MHz
	Offset-3 Start Freq	1.995 MHz
	Offset-4 Start Freq	2.75 MHz
	Offset-5 Start Freq	1.265 MHz
	Offset-6 Start Freq	4.015 MHz
	Offset-1 Stop Freq	1.265 MHz
	Offset-2 Stop Freq	1.995 MHz
	Offset-3 Stop Freq	2.265 MHz
	Offset-4 Stop Freq	4.5 MHz
	Offset-5 Stop Freq	2.265 MHz
	Offset-6 Stop Freq	16.015 MHz
	Offset-1 Reference Level	Auto
	Offset-2 Reference Level	Auto
	Offset-3 Reference Level	Auto
	Offset-4 Reference Level	Auto
	Offset-5 Reference Level	Auto
	Offset-6 Reference Level	Auto
	Offset-1 RBW	30 kHz
	Offset-2 RBW	30 kHz
	Offset-3 RBW	30 kHz
Offset-4 RBW	1 MHz	
Offset-5 RBW	30 kHz	
Offset-6 RBW	30 kHz	

Table C-5 Standard parameters for Spectrum Emission Mask (Cont'd)

Standard	Parameter Name	Setting
CDMA2000 Forward Link Band Class 1,4,8,14,15 (Pout ≥ 33dBm)	Offset-1 Sweep Time	Auto
	Offset-2 Sweep Time	Auto
	Offset-3 Sweep Time	Auto
	Offset-4 Sweep Time	Auto
	Offset-5 Sweep Time	Auto
	Offset-6 Sweep Time	Auto
	Offset-1 Auto Sweep Time Select	Normal
	Offset-2 Auto Sweep Time Select	Normal
	Offset-3 Auto Sweep Time Select	Normal
	Offset-4 Auto Sweep Time Select	Normal
	Offset-5 Auto Sweep Time Select	Normal
	Offset-6 Auto Sweep Time Select	Normal
	Offset-1 Detection	RMS
	Offset-2 Detection	RMS
	Offset-3 Detection	RMS
	Offset-4 Detection	RMS
	Offset-5 Detection	RMS
	Offset-6 Detection	RMS
	Offset-1 Trace Point	101
	Offset-2 Trace Point	101
	Offset-3 Trace Point	101
	Offset-4 Trace Point	101
	Offset-5 Trace Point	101
	Offset-6 Trace Point	501
	Offset-1 Integrate BW	Auto
	Offset-2 Integrate BW	Auto
	Offset-3 Integrate BW	Auto
	Offset-4 Integrate BW	Auto
Offset-5 Integrate BW	Auto	
Offset-6 Integrate BW	Auto	

Table C-5 Standard parameters for Spectrum Emission Mask (Cont'd)

Standard	Parameter Name	Setting
CDMA2000 Forward Link Band Class 1,4,8,14,15 (Pout ≥ 33dBm)	Offset-1 On/Off	On
	Offset-2 On/Off	On
	Offset-3 On/Off	On
	Offset-4 On/Off	On
	Offset-5 On/Off	Off
	Offset-6 On/Off	Off
	Limit-1 ABS1 Start Level	-13.0 dBm
	Limit-2 ABS1 Start Level	-9.0 dBm
	Limit-3 ABS1 Start Level	-9.0 dBm
	Limit-4 ABS1 Start Level	-13.0 dBm
	Limit-5 ABS1 Start Level	-9.0 dBm
	Limit-6 ABS1 Start Level	-30.0 dBm
	Limit-1 ABS1 Stop Level	-13.0 dBm
	Limit-2 ABS1 Stop Level	-9.0 dBm
	Limit-3 ABS1 Stop Level	-9.0 dBm
	Limit-4 ABS1 Stop Level	-13.0 dBm
	Limit-5 ABS1 Stop Level	-9.0 dBm
	Limit-6 ABS1 Stop Level	-30.0 dBm
	Limit-1 ABS2 Start Level	-27.0 dBm
	Limit-2 ABS2 Start Level	-27.0 dBm
	Limit-3 ABS2 Start Level	-22.0 dBm
	Limit-4 ABS2 Start Level	-27.0 dBm
	Limit-5 ABS2 Start Level	-27.0 dBm
	Limit-6 ABS2 Start Level	-27.0 dBm
	Limit-1 ABS2 Stop Level	-27.0 dBm
	Limit-2 ABS2 Stop Level	-27.0 dBm
	Limit-3 ABS2 Stop Level	-22.0 dBm
	Limit-4 ABS2 Stop Level	-27.0 dBm
	Limit-5 ABS2 Stop Level	-27.0 dBm
	Limit-6 ABS2 Stop Level	-27.0 dBm

Table C-5 Standard parameters for Spectrum Emission Mask (Cont'd)

Standard	Parameter Name	Setting
CDMA2000 Forward Link Band Class 1,4,8,14,15 (Pout ≥ 33dBm)	Limit-1 REL Start Level	-45.0 dB
	Limit-2 REL Start Level	-45.0 dB
	Limit-3 REL Start Level	-55.0 dB
	Limit-4 REL Start Level	-45.0 dB
	Limit-5 REL Start Level	-45.0 dB
	Limit-6 REL Start Level	-45.0 dB
	Limit-1 REL Stop Level	-45.0 dB
	Limit-2 REL Stop Level	-45.0 dB
	Limit-3 REL Stop Level	-55.0 dB
	Limit-4 REL Stop Level	-45.0 dB
	Limit-5 REL Stop Level	-45.0 dB
	Limit-6 REL Stop Level	-45.0 dB
	Limit-1 Fail Logic	REL
	Limit-2 Fail Logic	ABS1 and REL
	Limit-3 Fail Logic	REL
	Limit-4 Fail Logic	ABS1
	Limit-5 Fail Logic	ABS1
	Limit-6 Fail Logic	ABS1

Table C-5 Standard parameters for Spectrum Emission Mask (Cont'd)

Standard	Parameter Name	Setting
CDMA2000 Forward Link Band Class 6 (Pout < 28dBm)	Limit Side	Both
	Noise Cancel	Off
	Reference Mode	Channel
	Channel BW	1.23 MHz
	RBW	30 kHz
	VBW	Auto
	Sweep Time	Auto
	Auto Sweep Time Select	Normal
	Detection	RMS
	Trace Point	101
	Filter Type	Rect
	Offset-1 Start Freq	900 kHz
	Offset-2 Start Freq	1.265 MHz
	Offset-3 Start Freq	1.465 MHz
	Offset-4 Start Freq	1.995 MHz
	Offset-5 Start Freq	2.75 MHz
	Offset-6 Start Freq	4.015 MHz
	Offset-1 Stop Freq	1.995 MHz
	Offset-2 Stop Freq	1.465 MHz
	Offset-3 Stop Freq	2.265 MHz
	Offset-4 Stop Freq	2.265 MHz
	Offset-5 Stop Freq	4.5 MHz
	Offset-6 Stop Freq	16.015 MHz
	Offset-1 Reference Level	Auto
	Offset-2 Reference Level	Auto
	Offset-3 Reference Level	Auto
	Offset-4 Reference Level	Auto
	Offset-5 Reference Level	Auto
	Offset-6 Reference Level	Auto
	Offset-1 RBW	30 kHz
	Offset-2 RBW	30 kHz
	Offset-3 RBW	30 kHz
Offset-4 RBW	30 kHz	
Offset-5 RBW	1 MHz	
Offset-6 RBW	30 kHz	

Table C-5 Standard parameters for Spectrum Emission Mask (Cont'd)

Standard	Parameter Name	Setting
CDMA2000 Forward Link Band Class 6 (Pout < 28dBm)	Offset-1 Sweep Time	Auto
	Offset-2 Sweep Time	Auto
	Offset-3 Sweep Time	Auto
	Offset-4 Sweep Time	Auto
	Offset-5 Sweep Time	Auto
	Offset-6 Sweep Time	Auto
	Offset-1 Auto Sweep Time Select	Normal
	Offset-2 Auto Sweep Time Select	Normal
	Offset-3 Auto Sweep Time Select	Normal
	Offset-4 Auto Sweep Time Select	Normal
	Offset-5 Auto Sweep Time Select	Normal
	Offset-6 Auto Sweep Time Select	Normal
	Offset-1 Detection	RMS
	Offset-2 Detection	RMS
	Offset-3 Detection	RMS
	Offset-4 Detection	RMS
	Offset-5 Detection	RMS
	Offset-6 Detection	RMS
	Offset-1 Trace Point	101
	Offset-2 Trace Point	101
	Offset-3 Trace Point	101
	Offset-4 Trace Point	101
	Offset-5 Trace Point	101
	Offset-6 Trace Point	501
	Offset-1 Integrate BW	Auto
	Offset-2 Integrate BW	Auto
	Offset-3 Integrate BW	Auto
	Offset-4 Integrate BW	Auto
	Offset-5 Integrate BW	Auto
	Offset-6 Integrate BW	Auto

Table C-5 Standard parameters for Spectrum Emission Mask (Cont'd)

Standard	Parameter Name	Setting
CDMA2000 Forward Link Band Class 6 (Pout < 28dBm)	Offset-1 On/Off	On
	Offset-2 On/Off	On
	Offset-3 On/Off	On
	Offset-4 On/Off	On
	Offset-5 On/Off	On
	Offset-6 On/Off	Off
	Limit-1 ABS1 Start Level	-13.0 dBm
	Limit-2 ABS1 Start Level	-13.0 dBm
	Limit-3 ABS1 Start Level	-13.0 dBm
	Limit-4 ABS1 Start Level	-9.0 dBm
	Limit-5 ABS1 Start Level	-13.0 dBm
	Limit-6 ABS1 Start Level	-30.0 dBm
	Limit-1 ABS1 Stop Level	-13.0 dBm
	Limit-2 ABS1 Stop Level	-13.0 dBm
	Limit-3 ABS1 Stop Level	-26.6 dBm
	Limit-4 ABS1 Stop Level	-9.0 dBm
	Limit-5 ABS1 Stop Level	-13.0 dBm
	Limit-6 ABS1 Stop Level	-30.0 dBm
	Limit-1 ABS2 Start Level	-27.0 dBm
	Limit-2 ABS2 Start Level	-27.0 dBm
	Limit-3 ABS2 Start Level	-22.0 dBm
	Limit-4 ABS2 Start Level	-22.0 dBm
	Limit-5 ABS2 Start Level	-27.0 dBm
	Limit-6 ABS2 Start Level	-27.0 dBm
	Limit-1 ABS2 Stop Level	-27.0 dBm
	Limit-2 ABS2 Stop Level	-27.0 dBm
	Limit-3 ABS2 Stop Level	-22.0 dBm
	Limit-4 ABS2 Stop Level	-22.0 dBm
	Limit-5 ABS2 Stop Level	-27.0 dBm
	Limit-6 ABS2 Stop Level	-27.0 dBm

Table C-5 Standard parameters for Spectrum Emission Mask (Cont'd)

Standard	Parameter Name	Setting
CDMA2000 Forward Link Band Class 6 (Pout < 28dBm)	Limit-1 REL Start Level	-45.0 dB
	Limit-2 REL Start Level	-45.0 dB
	Limit-3 REL Start Level	-55.0 dB
	Limit-4 REL Start Level	-50.0 dB
	Limit-5 REL Start Level	-45.0 dB
	Limit-6 REL Start Level	-45.0 dB
	Limit-1 REL Stop Level	-45.0 dB
	Limit-2 REL Stop Level	-45.0 dB
	Limit-3 REL Stop Level	-55.0 dB
	Limit-4 REL Stop Level	-50.0 dB
	Limit-5 REL Stop Level	-45.0 dB
	Limit-6 REL Stop Level	-45.0 dB
	Limit-1 Fail Logic	REL
	Limit-2 Fail Logic	ABS1
	Limit-3 Fail Logic	ABS1
	Limit-4 Fail Logic	REL
	Limit-5 Fail Logic	ABS1
	Limit-6 Fail Logic	ABS1

Table C-5 Standard parameters for Spectrum Emission Mask (Cont'd)

Standard	Parameter Name	Setting
CDMA2000 Forward Link Band Class 6 (28dBm ≤ Pout < 33dBm)	Limit Side	Both
	Noise Cancel	Off
	Reference Mode	Channel
	Channel BW	1.23 MHz
	RBW	30 kHz
	VBW	Auto
	Sweep Time	Auto
	Auto Sweep Time Select	Normal
	Detection	RMS
	Trace Point	101
	Filter Type	Rect
	Offset-1 Start Freq	900 kHz
	Offset-2 Start Freq	1.265 MHz
	Offset-3 Start Freq	1.465 MHz
	Offset-4 Start Freq	1.995 MHz
	Offset-5 Start Freq	2.75 MHz
	Offset-6 Start Freq	4.015 MHz
	Offset-1 Stop Freq	1.995 MHz
	Offset-2 Stop Freq	1.465 MHz
	Offset-3 Stop Freq	2.265 MHz
	Offset-4 Stop Freq	2.265 MHz
	Offset-5 Stop Freq	4.5 MHz
	Offset-6 Stop Freq	16.015 MHz
	Offset-1 Reference Level	Auto
	Offset-2 Reference Level	Auto
	Offset-3 Reference Level	Auto
	Offset-4 Reference Level	Auto
	Offset-5 Reference Level	Auto
	Offset-6 Reference Level	Auto
	Offset-1 RBW	30 kHz
	Offset-2 RBW	30 kHz
	Offset-3 RBW	30 kHz
Offset-4 RBW	30 kHz	
Offset-5 RBW	1 MHz	
Offset-6 RBW	30 kHz	

Table C-5 Standard parameters for Spectrum Emission Mask (Cont'd)

Standard	Parameter Name	Setting
CDMA2000 Forward Link Band Class 6 (28dBm ≤ Pout < 33dBm)	Offset-1 Sweep Time	Auto
	Offset-2 Sweep Time	Auto
	Offset-3 Sweep Time	Auto
	Offset-4 Sweep Time	Auto
	Offset-5 Sweep Time	Auto
	Offset-6 Sweep Time	Auto
	Offset-1 Auto Sweep Time Select	Normal
	Offset-2 Auto Sweep Time Select	Normal
	Offset-3 Auto Sweep Time Select	Normal
	Offset-4 Auto Sweep Time Select	Normal
	Offset-5 Auto Sweep Time Select	Normal
	Offset-6 Auto Sweep Time Select	Normal
	Offset-1 Detection	RMS
	Offset-2 Detection	RMS
	Offset-3 Detection	RMS
	Offset-4 Detection	RMS
	Offset-5 Detection	RMS
	Offset-6 Detection	RMS
	Offset-1 Trace Point	101
	Offset-2 Trace Point	101
	Offset-3 Trace Point	101
	Offset-4 Trace Point	101
	Offset-5 Trace Point	101
	Offset-6 Trace Point	501
	Offset-1 Integrate BW	Auto
	Offset-2 Integrate BW	Auto
	Offset-3 Integrate BW	Auto
	Offset-4 Integrate BW	Auto
	Offset-5 Integrate BW	Auto
	Offset-6 Integrate BW	Auto

Table C-5 Standard parameters for Spectrum Emission Mask (Cont'd)

Standard	Parameter Name	Setting
CDMA2000 Forward Link Band Class 6 (28dBm ≤ Pout < 33dBm)	Offset-1 On/Off	On
	Offset-2 On/Off	On
	Offset-3 On/Off	On
	Offset-4 On/Off	Off
	Offset-5 On/Off	On
	Offset-6 On/Off	Off
	Limit-1 ABS1 Start Level	-13.0 dBm
	Limit-2 ABS1 Start Level	-13.0 dBm
	Limit-3 ABS1 Start Level	-13.0 dBm
	Limit-4 ABS1 Start Level	-9.0 dBm
	Limit-5 ABS1 Start Level	-13.0 dBm
	Limit-6 ABS1 Start Level	-30.0 dBm
	Limit-1 ABS1 Stop Level	-13.0 dBm
	Limit-2 ABS1 Stop Level	-13.0 dBm
	Limit-3 ABS1 Stop Level	-26.6 dBm
	Limit-4 ABS1 Stop Level	-9.0 dBm
	Limit-5 ABS1 Stop Level	-13.0 dBm
	Limit-6 ABS1 Stop Level	-30.0 dBm
	Limit-1 ABS2 Start Level	-27.0 dBm
	Limit-2 ABS2 Start Level	-27.0 dBm
	Limit-3 ABS2 Start Level	-22.0 dBm
	Limit-4 ABS2 Start Level	-22.0 dBm
	Limit-5 ABS2 Start Level	-27.0 dBm
	Limit-6 ABS2 Start Level	-27.0 dBm
	Limit-1 ABS2 Stop Level	-27.0 dBm
	Limit-2 ABS2 Stop Level	-27.0 dBm
	Limit-3 ABS2 Stop Level	-22.0 dBm
	Limit-4 ABS2 Stop Level	-22.0 dBm
	Limit-5 ABS2 Stop Level	-27.0 dBm
	Limit-6 ABS2 Stop Level	-27.0 dBm

Table C-5 Standard parameters for Spectrum Emission Mask (Cont'd)

Standard	Parameter Name	Setting
CDMA2000 Forward Link Band Class 6 (28dBm ≤ Pout < 33dBm)	Limit-1 REL Start Level	-45.0 dB
	Limit-2 REL Start Level	-45.0 dB
	Limit-3 REL Start Level	-55.0 dB
	Limit-4 REL Start Level	-50.0 dB
	Limit-5 REL Start Level	-45.0 dB
	Limit-6 REL Start Level	-45.0 dB
	Limit-1 REL Stop Level	-45.0 dB
	Limit-2 REL Stop Level	-45.0 dB
	Limit-3 REL Stop Level	-55.0 dB
	Limit-4 REL Stop Level	-50.0 dB
	Limit-5 REL Stop Level	-45.0 dB
	Limit-6 REL Stop Level	-45.0 dB
	Limit-1 Fail Logic	REL
	Limit-2 Fail Logic	ABS1
	Limit-3 Fail Logic	ABS1
	Limit-4 Fail Logic	REL
	Limit-5 Fail Logic	ABS1
	Limit-6 Fail Logic	ABS1

Table C-5 Standard parameters for Spectrum Emission Mask (Cont'd)

Standard	Parameter Name	Setting
CDMA2000 Forward Link Band Class 6 (Pout ≥ 33dBm)	Limit Side	Both
	Noise Cancel	Off
	Reference Mode	Channel
	Channel BW	1.23 MHz
	RBW	30 kHz
	VBW	Auto
	Sweep Time	Auto
	Auto Sweep Time Select	Normal
	Detection	RMS
	Trace Point	101
	Filter Type	Rect
	Offset-1 Start Freq	900 kHz
	Offset-2 Start Freq	1.265 MHz
	Offset-3 Start Freq	1.465 MHz
	Offset-4 Start Freq	1.995 MHz
	Offset-5 Start Freq	2.75 MHz
	Offset-6 Start Freq	4.015 MHz
	Offset-1 Stop Freq	1.995 MHz
	Offset-2 Stop Freq	1.465 MHz
	Offset-3 Stop Freq	2.265 MHz
	Offset-4 Stop Freq	2.265 MHz
	Offset-5 Stop Freq	4.5 MHz
	Offset-6 Stop Freq	16.015 MHz
	Offset-1 Reference Level	Auto
	Offset-2 Reference Level	Auto
	Offset-3 Reference Level	Auto
	Offset-4 Reference Level	Auto
	Offset-5 Reference Level	Auto
	Offset-6 Reference Level	Auto
	Offset-1 RBW	30 kHz
	Offset-2 RBW	30 kHz
	Offset-3 RBW	30 kHz
Offset-4 RBW	30 kHz	
Offset-5 RBW	1 MHz	
Offset-6 RBW	30 kHz	

Table C-5 Standard parameters for Spectrum Emission Mask (Cont'd)

Standard	Parameter Name	Setting
CDMA2000 Forward Link Band Class 6 (Pout ≥ 33dBm)	Offset-1 Sweep Time	Auto
	Offset-2 Sweep Time	Auto
	Offset-3 Sweep Time	Auto
	Offset-4 Sweep Time	Auto
	Offset-5 Sweep Time	Auto
	Offset-6 Sweep Time	Auto
	Offset-1 Auto Sweep Time Select	Normal
	Offset-2 Auto Sweep Time Select	Normal
	Offset-3 Auto Sweep Time Select	Normal
	Offset-4 Auto Sweep Time Select	Normal
	Offset-5 Auto Sweep Time Select	Normal
	Offset-6 Auto Sweep Time Select	Normal
	Offset-1 Detection	RMS
	Offset-2 Detection	RMS
	Offset-3 Detection	RMS
	Offset-4 Detection	RMS
	Offset-5 Detection	RMS
	Offset-6 Detection	RMS
	Offset-1 Trace Point	101
	Offset-2 Trace Point	101
	Offset-3 Trace Point	101
	Offset-4 Trace Point	101
	Offset-5 Trace Point	101
	Offset-6 Trace Point	501
	Offset-1 Integrate BW	Auto
	Offset-2 Integrate BW	Auto
	Offset-3 Integrate BW	Auto
	Offset-4 Integrate BW	Auto
	Offset-5 Integrate BW	Auto
	Offset-6 Integrate BW	Auto

Table C-5 Standard parameters for Spectrum Emission Mask (Cont'd)

Standard	Parameter Name	Setting
CDMA2000 Forward Link Band Class 6 (Pout ≥ 33dBm)	Offset-1 On/Off	On
	Offset-2 On/Off	On
	Offset-3 On/Off	On
	Offset-4 On/Off	On
	Offset-5 On/Off	On
	Offset-6 On/Off	Off
	Limit-1 ABS1 Start Level	-13.0 dBm
	Limit-2 ABS1 Start Level	-13.0 dBm
	Limit-3 ABS1 Start Level	-13.0 dBm
	Limit-4 ABS1 Start Level	-9.0 dBm
	Limit-5 ABS1 Start Level	-13.0 dBm
	Limit-6 ABS1 Start Level	-30.0 dBm
	Limit-1 ABS1 Stop Level	-13.0 dBm
	Limit-2 ABS1 Stop Level	-13.0 dBm
	Limit-3 ABS1 Stop Level	-26.6 dBm
	Limit-4 ABS1 Stop Level	-9.0 dBm
	Limit-5 ABS1 Stop Level	-13.0 dBm
	Limit-6 ABS1 Stop Level	-30.0 dBm
	Limit-1 ABS2 Start Level	-27.0 dBm
	Limit-2 ABS2 Start Level	-27.0 dBm
	Limit-3 ABS2 Start Level	-22.0 dBm
	Limit-4 ABS2 Start Level	-22.0 dBm
	Limit-5 ABS2 Start Level	-27.0 dBm
	Limit-6 ABS2 Start Level	-27.0 dBm
	Limit-1 ABS2 Stop Level	-27.0 dBm
	Limit-2 ABS2 Stop Level	-27.0 dBm
	Limit-3 ABS2 Stop Level	-22.0 dBm
	Limit-4 ABS2 Stop Level	-22.0 dBm
	Limit-5 ABS2 Stop Level	-27.0 dBm
	Limit-6 ABS2 Stop Level	-27.0 dBm

Table C-5 Standard parameters for Spectrum Emission Mask (Cont'd)

Standard	Parameter Name	Setting
CDMA2000 Forward Link Band Class 6 (Pout ≥ 33dBm)	Limit-1 REL Start Level	-45.0 dB
	Limit-2 REL Start Level	-45.0 dB
	Limit-3 REL Start Level	-55.0 dB
	Limit-4 REL Start Level	-55.0 dB
	Limit-5 REL Start Level	-45.0 dB
	Limit-6 REL Start Level	-45.0 dB
	Limit-1 REL Stop Level	-45.0 dB
	Limit-2 REL Stop Level	-45.0 dB
	Limit-3 REL Stop Level	-55.0 dB
	Limit-4 REL Stop Level	-55.0 dB
	Limit-5 REL Stop Level	-45.0 dB
	Limit-6 REL Stop Level	-45.0 dB
	Limit-1 Fail Logic	REL
	Limit-2 Fail Logic	ABS1
	Limit-3 Fail Logic	ABS1
	Limit-4 Fail Logic	REL
	Limit-5 Fail Logic	ABS1
	Limit-6 Fail Logic	ABS1

Table C-5 Standard parameters for Spectrum Emission Mask (Cont'd)

Standard	Parameter Name	Setting
CDMA2000 Forward Link Band Class 11,12	Limit Side	Both
	Noise Cancel	Off
	Reference Mode	Channel
	Channel BW	1.23 MHz
	RBW	30 kHz
	VBW	Auto
	Sweep Time	Auto
	Auto Sweep Time Select	Normal
	Detection	RMS
	Trace Point	101
	Filter Type	Rect
	Offset-1 Start Freq	765 kHz
	Offset-2 Start Freq	900 kHz
	Offset-3 Start Freq	1.14 MHz
	Offset-4 Start Freq	1.995 MHz
	Offset-5 Start Freq	4.05 MHz
	Offset-1 Stop Freq	900 kHz
	Offset-2 Stop Freq	1.14 MHz
	Offset-3 Stop Freq	1.995 MHz
	Offset-4 Stop Freq	4.015 MHz
	Offset-5 Stop Freq	6.05 MHz
	Offset-1 Reference Level	Auto
	Offset-2 Reference Level	Auto
	Offset-3 Reference Level	Auto
	Offset-4 Reference Level	Auto
	Offset-5 Reference Level	Auto
	Offset-1 RBW	30 kHz
	Offset-2 RBW	30 kHz
	Offset-3 RBW	30 kHz
	Offset-4 RBW	30 kHz
	Offset-5 RBW	100 kHz
	Offset-1 Sweep Time	Auto
Offset-2 Sweep Time	Auto	
Offset-3 Sweep Time	Auto	
Offset-4 Sweep Time	Auto	
Offset-5 Sweep Time	Auto	

Table C-5 Standard parameters for Spectrum Emission Mask (Cont'd)

Standard	Parameter Name	Setting
CDMA2000 Forward Link Band Class 11,12	Offset-1 Auto Sweep Time Select	Normal
	Offset-2 Auto Sweep Time Select	Normal
	Offset-3 Auto Sweep Time Select	Normal
	Offset-4 Auto Sweep Time Select	Normal
	Offset-5 Auto Sweep Time Select	Normal
	Offset-1 Detection	RMS
	Offset-2 Detection	RMS
	Offset-3 Detection	RMS
	Offset-4 Detection	RMS
	Offset-5 Detection	RMS
	Offset-1 Trace Point	101
	Offset-2 Trace Point	101
	Offset-3 Trace Point	101
	Offset-4 Trace Point	101
	Offset-5 Trace Point	101
	Offset-1 Integrate BW	Auto
	Offset-2 Integrate BW	Auto
	Offset-3 Integrate BW	Auto
	Offset-4 Integrate BW	Auto
	Offset-5 Integrate BW	Auto
	Offset-1 On/Off	On
	Offset-2 On/Off	On
	Offset-3 On/Off	On
	Offset-4 On/Off	On
	Offset-5 On/Off	On
	Offset-6 On/Off	Off

Table C-5 Standard parameters for Spectrum Emission Mask (Cont'd)

Standard	Parameter Name	Setting
CDMA2000 Forward Link Band Class 11,12	Limit-1 ABS1 Start Level	-13.0 dBm
	Limit-2 ABS1 Start Level	-9.0 dBm
	Limit-3 ABS1 Start Level	-9.0 dBm
	Limit-4 ABS1 Start Level	-13.0 dBm
	Limit-5 ABS1 Start Level	-36.0 dBm
	Limit-1 ABS1 Stop Level	-13.0 dBm
	Limit-2 ABS1 Stop Level	-9.0 dBm
	Limit-3 ABS1 Stop Level	-9.0 dBm
	Limit-4 ABS1 Stop Level	-13.0 dBm
	Limit-5 ABS1 Stop Level	-36.0 dBm
	Limit-1 ABS2 Start Level	-27.0 dBm
	Limit-2 ABS2 Start Level	-27.0 dBm
	Limit-3 ABS2 Start Level	-22.0 dBm
	Limit-4 ABS2 Start Level	-27.0 dBm
	Limit-5 ABS2 Start Level	-27.0 dBm
	Limit-1 ABS2 Stop Level	-27.0 dBm
	Limit-2 ABS2 Stop Level	-27.0 dBm
	Limit-3 ABS2 Stop Level	-22.0 dBm
	Limit-4 ABS2 Stop Level	-27.0 dBm
	Limit-5 ABS2 Stop Level	-27.0 dBm
	Limit-1 REL Start Level	-45.0 dB
	Limit-2 REL Start Level	-60.0 dB
	Limit-3 REL Start Level	-65.0 dB
	Limit-4 REL Start Level	-75.0 dB
	Limit-5 REL Start Level	-70.0 dB
	Limit-1 REL Stop Level	-60.0 dB
	Limit-2 REL Stop Level	-65.0 dB
	Limit-3 REL Stop Level	-65.0 dB
	Limit-4 REL Stop Level	-75.0 dB
	Limit-5 REL Stop Level	-70.0 dB
	Limit-1 Fail Logic	REL
	Limit-2 Fail Logic	REL
Limit-3 Fail Logic	REL	
Limit-4 Fail Logic	REL	
Limit-5 Fail Logic	ABS1	

EV-DO

Table C-5 Standard parameters for Spectrum Emission Mask (Cont'd)

Standard	Parameter Name	Setting
EV-DO Forward Link Band Class 0,2,5,7,9,10	Limit Side	Both
	Noise Cancel	Off
	Reference Mode	Channel
	Channel BW	1.23 MHz
	RBW	30 kHz
	VBW	Auto
	Sweep Time	20 ms
	Auto Sweep Time Select	Normal
	Detection	RMS
	Trace Point	101
	Filter Type	Rect
	Offset-1 Start Freq	765 kHz
	Offset-2 Start Freq	1.995 MHz
	Offset-3 Start Freq	3.2531 MHz
	Offset-4 Start Freq	4.0005 MHz
	Offset-5 Start Freq	6.405 MHz
	Offset-1 Stop Freq	1.995 MHz
	Offset-2 Stop Freq	4.015 MHz
	Offset-3 Stop Freq	4.0031 MHz
	Offset-4 Stop Freq	6.4005 MHz
	Offset-5 Stop Freq	16.005 MHz
	Offset-1 Reference Level	Auto
	Offset-2 Reference Level	Auto
	Offset-3 Reference Level	Auto
	Offset-4 Reference Level	Auto
	Offset-5 Reference Level	Auto
	Offset-1 RBW	30 kHz
	Offset-2 RBW	30 kHz
	Offset-3 RBW	100 Hz
	Offset-4 RBW	1 kHz
	Offset-5 RBW	10 kHz
	Offset-1 Sweep Time	20 ms
Offset-2 Sweep Time	20 ms	
Offset-3 Sweep Time	Auto	
Offset-4 Sweep Time	Auto	
Offset-5 Sweep Time	Auto	

Table C-5 Standard parameters for Spectrum Emission Mask (Cont'd)

Standard	Parameter Name	Setting
EV-DO Forward Link Band Class 0,2,5,7,9,10	Offset-1 Auto Sweep Time Select	Normal
	Offset-2 Auto Sweep Time Select	Normal
	Offset-3 Auto Sweep Time Select	Normal
	Offset-4 Auto Sweep Time Select	Normal
	Offset-5 Auto Sweep Time Select	Normal
	Offset-1 Detection	RMS
	Offset-2 Detection	RMS
	Offset-3 Detection	RMS
	Offset-4 Detection	RMS
	Offset-5 Detection	RMS
	Offset-1 Trace Point	101
	Offset-2 Trace Point	101
	Offset-3 Trace Point	10001
	Offset-4 Trace Point	5001
	Offset-5 Trace Point	1001
	Offset-1 Integrate BW	Auto
	Offset-2 Integrate BW	Auto
	Offset-3 Integrate BW	6.25 kHz
	Offset-4 Integrate BW	Auto
	Offset-5 Integrate BW	Auto
	Offset-1 On/Off	On
	Offset-2 On/Off	On
	Offset-3 On/Off	Off
	Offset-4 On/Off	Off
Offset-5 On/Off	Off	
Offset-6 On/Off	Off	

Table C-5 Standard parameters for Spectrum Emission Mask (Cont'd)

Standard	Parameter Name	Setting
EV-DO Forward Link Band Class 0,2,5,7,9,10	Limit-1 ABS1 Start Level	-13.0 dBm
	Limit-2 ABS1 Start Level	-13.0 dBm
	Limit-3 ABS1 Start Level	-46.0 dBm
	Limit-4 ABS1 Start Level	-36.0 dBm
	Limit-5 ABS1 Start Level	-36.0 dBm
	Limit-1 ABS1 Stop Level	-13.0 dBm
	Limit-2 ABS1 Stop Level	-13.0 dBm
	Limit-3 ABS1 Stop Level	-46.0 dBm
	Limit-4 ABS1 Stop Level	-36.0 dBm
	Limit-5 ABS1 Stop Level	-36.0 dBm
	Limit-1 ABS2 Start Level	-27.0 dBm
	Limit-2 ABS2 Start Level	-27.0 dBm
	Limit-3 ABS2 Start Level	-27.0 dBm
	Limit-4 ABS2 Start Level	-27.0 dBm
	Limit-5 ABS2 Start Level	-27.0 dBm
	Limit-1 ABS2 Stop Level	-27.0 dBm
	Limit-2 ABS2 Stop Level	-27.0 dBm
	Limit-3 ABS2 Stop Level	-27.0 dBm
	Limit-4 ABS2 Stop Level	-27.0 dBm
	Limit-5 ABS2 Stop Level	-27.0 dBm
	Limit-1 REL Start Level	-45.0 dB
	Limit-2 REL Start Level	-60.0 dB
	Limit-3 REL Start Level	-55.0 dB
	Limit-4 REL Start Level	-55.0 dB
	Limit-5 REL Start Level	-55.0 dB
	Limit-1 REL Stop Level	-45.0 dB
	Limit-2 REL Stop Level	-60.0 dB
	Limit-3 REL Stop Level	-55.0 dB
	Limit-4 REL Stop Level	-55.0 dB
	Limit-5 REL Stop Level	-55.0 dB
	Limit-1 Fail Logic	REL
	Limit-2 Fail Logic	REL
Limit-3 Fail Logic	ABS1	
Limit-4 Fail Logic	ABS1	
Limit-5 Fail Logic	ABS1	
Limit-6 Fail Logic	Off	

Table C-5 Standard parameters for Spectrum Emission Mask (Cont'd)

Standard	Parameter Name	Setting
EV-DO Forward Link Band Class 1,4,14,15	Limit Side	Both
	Noise Cancel	Off
	Reference Mode	Channel
	Channel BW	1.23 MHz
	RBW	30 kHz
	VBW	Auto
	Sweep Time	20 ms
	Auto Sweep Time Select	Normal
	Detection	RMS
	Trace Point	101
	Filter Type	Rect
	Offset-1 Start Freq	900 kHz
	Offset-2 Start Freq	1.265 MHz
	Offset-3 Start Freq	1.995 MHz
	Offset-4 Start Freq	2.75 MHz
	Offset-5 Start Freq	1.265 MHz
	Offset-1 Stop Freq	1.265 MHz
	Offset-2 Stop Freq	1.995 MHz
	Offset-3 Stop Freq	2.265 MHz
	Offset-4 Stop Freq	4.5 MHz
	Offset-5 Stop Freq	2.265 MHz
	Offset-1 Reference Level	Auto
	Offset-2 Reference Level	Auto
	Offset-3 Reference Level	Auto
	Offset-4 Reference Level	Auto
	Offset-5 Reference Level	Auto
	Offset-1 RBW	30 kHz
	Offset-2 RBW	30 kHz
	Offset-3 RBW	30 kHz
	Offset-4 RBW	1 MHz
	Offset-5 RBW	30 kHz
	Offset-1 Sweep Time	20 ms
Offset-2 Sweep Time	20 ms	
Offset-3 Sweep Time	20 ms	
Offset-4 Sweep Time	20 ms	
Offset-5 Sweep Time	20 ms	

Table C-5 Standard parameters for Spectrum Emission Mask (Cont'd)

Standard	Parameter Name	Setting
EV-DO Forward Link Band Class 1,4,14,15	Offset-1 Auto Sweep Time Select	Normal
	Offset-2 Auto Sweep Time Select	Normal
	Offset-3 Auto Sweep Time Select	Normal
	Offset-4 Auto Sweep Time Select	Normal
	Offset-5 Auto Sweep Time Select	Normal
	Offset-1 Detection	RMS
	Offset-2 Detection	RMS
	Offset-3 Detection	RMS
	Offset-4 Detection	RMS
	Offset-5 Detection	RMS
	Offset-1 Trace Point	101
	Offset-2 Trace Point	101
	Offset-3 Trace Point	101
	Offset-4 Trace Point	101
	Offset-5 Trace Point	101
	Offset-1 Integrate BW	Auto
	Offset-2 Integrate BW	Auto
	Offset-3 Integrate BW	Auto
	Offset-4 Integrate BW	Auto
	Offset-5 Integrate BW	Auto
	Offset-1 On/Off	On
	Offset-2 On/Off	On
	Offset-3 On/Off	On
	Offset-4 On/Off	On
	Offset-5 On/Off	Off
Offset-6 On/Off	Off	

Table C-5 Standard parameters for Spectrum Emission Mask (Cont'd)

Standard	Parameter Name	Setting
EV-DO Forward Link Band Class 1,4,14,15	Limit-1 ABS1 Start Level	-13.0 dBm
	Limit-2 ABS1 Start Level	-9.0 dBm
	Limit-3 ABS1 Start Level	-13.0 dBm
	Limit-4 ABS1 Start Level	-13.0 dBm
	Limit-5 ABS1 Start Level	-9.0 dBm
	Limit-1 ABS1 Stop Level	-13.0 dBm
	Limit-2 ABS1 Stop Level	-9.0 dBm
	Limit-3 ABS1 Stop Level	-13.0 dBm
	Limit-4 ABS1 Stop Level	-13.0 dBm
	Limit-5 ABS1 Stop Level	-9.0 dBm
	Limit-1 ABS2 Start Level	-27.0 dBm
	Limit-2 ABS2 Start Level	-27.0 dBm
	Limit-3 ABS2 Start Level	-27.0 dBm
	Limit-4 ABS2 Start Level	-27.0 dBm
	Limit-5 ABS2 Start Level	-27.0 dBm
	Limit-1 ABS2 Stop Level	-27.0 dBm
	Limit-2 ABS2 Stop Level	-27.0 dBm
	Limit-3 ABS2 Stop Level	-27.0 dBm
	Limit-4 ABS2 Stop Level	-27.0 dBm
	Limit-5 ABS2 Stop Level	-27.0 dBm
	Limit-1 REL Start Level	-45.0 dB
	Limit-2 REL Start Level	-45.0 dB
	Limit-3 REL Start Level	-55.0 dB
	Limit-4 REL Start Level	-45.0 dB
	Limit-5 REL Start Level	-45.0 dB
	Limit-1 REL Stop Level	-45.0 dB
	Limit-2 REL Stop Level	-45.0 dB
	Limit-3 REL Stop Level	-55.0 dB
	Limit-4 REL Stop Level	-45.0 dB
	Limit-5 REL Stop Level	-45.0 dB
	Limit-1 Fail Logic	REL
	Limit-2 Fail Logic	ABS1 and REL
Limit-3 Fail Logic	REL	
Limit-4 Fail Logic	ABS1	
Limit-5 Fail Logic	ABS1	

Table C-5 Standard parameters for Spectrum Emission Mask

Standard	Parameter Name	Setting
EV-DO Forward Link Band Class 6,8,13	Limit Side	Both
	Noise Cancel	Off
	Reference Mode	Channel
	Channel BW	1.23 MHz
	RBW	30 kHz
	VBW	Auto
	Sweep Time	20 ms
	Auto Sweep Time Select	Normal
	Detection	RMS
	Trace Point	101
	Filter Type	Rect
	Offset-1 Start Freq	900 kHz
	Offset-2 Start Freq	1.265 MHz
	Offset-3 Start Freq	1.465 MHz
	Offset-4 Start Freq	1.995 MHz
	Offset-5 Start Freq	2.75 MHz
	Offset-1 Stop Freq	1.995 MHz
	Offset-2 Stop Freq	1.465 MHz
	Offset-3 Stop Freq	2.265 MHz
	Offset-4 Stop Freq	2.265 MHz
	Offset-5 Stop Freq	4.5 MHz
	Offset-1 Reference Level	Auto
	Offset-2 Reference Level	Auto
	Offset-3 Reference Level	Auto
	Offset-4 Reference Level	Auto
	Offset-5 Reference Level	Auto
	Offset-6 Reference Level	Auto
	Offset-1 RBW	30 kHz
	Offset-2 RBW	30 kHz
	Offset-3 RBW	30 kHz
	Offset-4 RBW	30 kHz
	Offset-5 RBW	1 MHz
	Offset-1 Sweep Time	20 ms
Offset-2 Sweep Time	20 ms	
Offset-3 Sweep Time	20 ms	
Offset-4 Sweep Time	20 ms	
Offset-5 Sweep Time	20 ms	

Table C-5 Standard parameters for Spectrum Emission Mask (Cont'd)

Standard	Parameter Name	Setting
EV-DO Forward Link Band Class 6,8,13	Offset-1 Auto Sweep Time Select	Normal
	Offset-2 Auto Sweep Time Select	Normal
	Offset-3 Auto Sweep Time Select	Normal
	Offset-4 Auto Sweep Time Select	Normal
	Offset-5 Auto Sweep Time Select	Normal
	Offset-1 Detection	RMS
	Offset-2 Detection	RMS
	Offset-3 Detection	RMS
	Offset-4 Detection	RMS
	Offset-5 Detection	RMS
	Offset-1 Trace Point	101
	Offset-2 Trace Point	101
	Offset-3 Trace Point	101
	Offset-4 Trace Point	101
	Offset-5 Trace Point	101
	Offset-1 Integrate BW	Auto
	Offset-2 Integrate BW	Auto
	Offset-3 Integrate BW	Auto
	Offset-4 Integrate BW	Auto
	Offset-5 Integrate BW	Auto
	Offset-1 On/Off	On
	Offset-2 On/Off	On
	Offset-3 On/Off	On
	Offset-4 On/Off	On
	Offset-5 On/Off	On
Offset-6 On/Off	Off	

Table C-5 Standard parameters for Spectrum Emission Mask (Cont'd)

Standard	Parameter Name	Setting
EV-DO Forward Link Band Class 6,8,13	Limit-1 ABS1 Start Level	-13.0 dBm
	Limit-2 ABS1 Start Level	-13.0 dBm
	Limit-3 ABS1 Start Level	-13.0 dBm
	Limit-4 ABS1 Start Level	-13.0 dBm
	Limit-5 ABS1 Start Level	-13.0 dBm
	Limit-1 ABS1 Stop Level	-13.0 dBm
	Limit-2 ABS1 Stop Level	-13.0 dBm
	Limit-3 ABS1 Stop Level	-26.6 dBm
	Limit-4 ABS1 Stop Level	-13.0 dBm
	Limit-5 ABS1 Stop Level	-13.0 dBm
	Limit-1 ABS2 Start Level	-27.0 dBm
	Limit-2 ABS2 Start Level	-27.0 dBm
	Limit-3 ABS2 Start Level	-22.0 dBm
	Limit-4 ABS2 Start Level	-27.0 dBm
	Limit-5 ABS2 Start Level	-27.0 dBm
	Limit-1 ABS2 Stop Level	-27.0 dBm
	Limit-2 ABS2 Stop Level	-27.0 dBm
	Limit-3 ABS2 Stop Level	-22.0 dBm
	Limit-4 ABS2 Stop Level	-27.0 dBm
	Limit-5 ABS2 Stop Level	-27.0 dBm
	Limit-1 REL Start Level	-45.0 dB
	Limit-2 REL Start Level	-45.0 dB
	Limit-3 REL Start Level	-50.0 dB
	Limit-4 REL Start Level	-55.0 dB
	Limit-5 REL Start Level	-45.0 dB
	Limit-1 REL Stop Level	-45.0 dB
	Limit-2 REL Stop Level	-45.0 dB
	Limit-3 REL Stop Level	-50.0 dB
	Limit-4 REL Stop Level	-55.0 dB
	Limit-5 REL Stop Level	-45.0 dB
	Limit-1 Fail Logic	REL
	Limit-2 Fail Logic	ABS1
Limit-3 Fail Logic	ABS1	
Limit-4 Fail Logic	REL	
Limit-5 Fail Logic	ABS1	
Limit-6 Fail Logic	Off	

Table C-5 Standard parameters for Spectrum Emission Mask

Standard	Parameter Name	Setting
EV-DO Forward Link Band Class 11,12	Limit Side	Both
	Noise Cancel	Off
	Reference Mode	Channel
	Channel BW	1.23 MHz
	RBW	30 kHz
	VBW	Auto
	Sweep Time	20 ms
	Auto Sweep Time Select	Normal
	Detection	RMS
	Trace Point	101
	Filter Type	Rect
	Offset-1 Start Freq	765 kHz
	Offset-2 Start Freq	900 kHz
	Offset-3 Start Freq	1.14 MHz
	Offset-4 Start Freq	1.995 MHz
	Offset-5 Start Freq	4.0005 MHz
	Offset-6 Start Freq	6.405 MHz
	Offset-1 Stop Freq	900 kHz
	Offset-2 Stop Freq	1.14 MHz
	Offset-3 Stop Freq	1.995 MHz
	Offset-4 Stop Freq	4.015 MHz
	Offset-5 Stop Freq	6.4005 MHz
	Offset-6 Stop Freq	16.005 MHz
	Offset-1 Reference Level	Auto
	Offset-2 Reference Level	Auto
	Offset-3 Reference Level	Auto
	Offset-4 Reference Level	Auto
	Offset-5 Reference Level	Auto
	Offset-6 Reference Level	Auto
	Offset-1 RBW	30 kHz
	Offset-2 RBW	30 kHz
	Offset-3 RBW	30 kHz
	Offset-4 RBW	30 kHz
Offset-5 RBW	1 kHz	
Offset-6 RBW	10 kHz	

Table C-5 Standard parameters for Spectrum Emission Mask (Cont'd)

Standard	Parameter Name	Setting
EV-DO Forward Link Band Class 11,12	Offset-1 Sweep Time	20 ms
	Offset-2 Sweep Time	20 ms
	Offset-3 Sweep Time	20 ms
	Offset-4 Sweep Time	20 ms
	Offset-5 Sweep Time	Auto
	Offset-6 Sweep Time	Auto
	Offset-1 Auto Sweep Time Select	Normal
	Offset-2 Auto Sweep Time Select	Normal
	Offset-3 Auto Sweep Time Select	Normal
	Offset-4 Auto Sweep Time Select	Normal
	Offset-5 Auto Sweep Time Select	Normal
	Offset-6 Auto Sweep Time Select	Normal
	Offset-1 Detection	RMS
	Offset-2 Detection	RMS
	Offset-3 Detection	RMS
	Offset-4 Detection	RMS
	Offset-5 Detection	RMS
	Offset-6 Detection	RMS
	Offset-1 Trace Point	101
	Offset-2 Trace Point	101
	Offset-3 Trace Point	101
	Offset-4 Trace Point	101
	Offset-5 Trace Point	5001
	Offset-6 Trace Point	1001
	Offset-1 Integrate BW	Auto
	Offset-2 Integrate BW	Auto
	Offset-3 Integrate BW	Auto
	Offset-4 Integrate BW	Auto
	Offset-5 Integrate BW	Auto
	Offset-6 Integrate BW	Auto

Table C-5 Standard parameters for Spectrum Emission Mask (Cont'd)

Standard	Parameter Name	Setting
EV-DO Forward Link Band Class 11,12	Offset-1 On/Off	On
	Offset-2 On/Off	On
	Offset-3 On/Off	On
	Offset-4 On/Off	On
	Offset-5 On/Off	Off
	Offset-6 On/Off	Off
	Limit-1 ABS1 Start Level	-13.0 dBm
	Limit-2 ABS1 Start Level	-9.0 dBm
	Limit-3 ABS1 Start Level	-9.0 dBm
	Limit-4 ABS1 Start Level	-13.0 dBm
	Limit-5 ABS1 Start Level	-36.0 dBm
	Limit-6 ABS1 Start Level	-36.0 dBm
	Limit-1 ABS1 Stop Level	-13.0 dBm
	Limit-2 ABS1 Stop Level	-9.0 dBm
	Limit-3 ABS1 Stop Level	-9.0 dBm
	Limit-4 ABS1 Stop Level	-13.0 dBm
	Limit-5 ABS1 Stop Level	-36.0 dBm
	Limit-6 ABS1 Stop Level	-36.0 dBm
	Limit-1 ABS2 Start Level	-27.0 dBm
	Limit-2 ABS2 Start Level	-27.0 dBm
	Limit-3 ABS2 Start Level	-22.0 dBm
	Limit-4 ABS2 Start Level	-27.0 dBm
	Limit-5 ABS2 Start Level	-27.0 dBm
	Limit-6 ABS2 Start Level	-27.0 dBm
	Limit-1 ABS2 Stop Level	-27.0 dBm
	Limit-2 ABS2 Stop Level	-27.0 dBm
	Limit-3 ABS2 Stop Level	-22.0 dBm
	Limit-4 ABS2 Stop Level	-27.0 dBm
	Limit-5 ABS2 Stop Level	-27.0 dBm
	Limit-6 ABS2 Stop Level	-27.0 dBm

Table C-5 Standard parameters for Spectrum Emission Mask (Cont'd)

Standard	Parameter Name	Setting
EV-DO Forward Link Band Class 11,12	Limit-1 REL Start Level	-45.0 dB
	Limit-2 REL Start Level	-60.0 dB
	Limit-3 REL Start Level	-65.0 dB
	Limit-4 REL Start Level	-75.0 dB
	Limit-5 REL Start Level	-55.0 dB
	Limit-6 REL Start Level	-55.0 dB
	Limit-1 REL Stop Level	-60.0 dB
	Limit-2 REL Stop Level	-65.0 dB
	Limit-3 REL Stop Level	-65.0 dB
	Limit-4 REL Stop Level	-75.0 dB
	Limit-5 REL Stop Level	-55.0 dB
	Limit-6 REL Stop Level	-55.0 dB
	Limit-1 Fail Logic	REL
	Limit-2 Fail Logic	REL
	Limit-3 Fail Logic	REL
	Limit-4 Fail Logic	REL
	Limit-5 Fail Logic	ABS1
	Limit-6 Fail Logic	ABS1

ISDB-Tmm

Table C-5 Standard parameters for Spectrum Emission Mask (Cont'd)

Standard	Parameter Name	Setting
ISDB-Tmm 14.2MHz BW	Limit Side	Both
	Noise Cancel	Off
	Reference Mode	Channel
	Channel BW	14.2 MHz
	RBW	10 kHz
	VBW	300 Hz
	Sweep Time	Auto
	Auto Sweep Time Select	Fast
	Detection	Positive
	Trace Point	1001
	Filter Type	Rect
	Offset-1 Start Freq	7.07 MHz
	Offset-2 Start Freq	7.14 MHz
	Offset-3 Start Freq	7.29 MHz
	Offset-4 Start Freq	8.64 MHz
	Offset-1 Stop Freq	7.14 MHz
	Offset-2 Stop Freq	7.29 MHz
	Offset-3 Stop Freq	8.64 MHz
	Offset-4 Stop Freq	35.45 MHz
	Offset-1 Reference Level	Auto
	Offset-2 Reference Level	Auto
	Offset-3 Reference Level	Auto
	Offset-4 Reference Level	Auto
	Offset-1 RBW	10 kHz
	Offset-2 RBW	10 kHz
	Offset-3 RBW	10 kHz
	Offset-4 RBW	10 kHz
	Offset-1 VBW	300 Hz
	Offset-2 VBW	300 Hz
	Offset-3 VBW	300 Hz
Offset-4 VBW	300 Hz	

Table C-5 Standard parameters for Spectrum Emission Mask (Cont'd)

Standard	Parameter Name	Setting
ISDB-Tmm 14.2MHz BW	Offset-1 SweepTime	Auto
	Offset-2 SweepTime	Auto
	Offset-3 SweepTime	Auto
	Offset-4 SweepTime	Auto
	Offset-1 Auto Sweep Time Select	Fast
	Offset-2 Auto Sweep Time Select	Fast
	Offset-3 Auto Sweep Time Select	Fast
	Offset-4 Auto Sweep Time Select	Fast
	Offset-1 Detection	Positive
	Offset-2 Detection	Positive
	Offset-3 Detection	Positive
	Offset-4 Detection	Positive
	Offset-1 TracePoint	1001
	Offset-2 TracePoint	1001
	Offset-3 TracePoint	1001
	Offset-4 TracePoint	1001
	Offset-1 Integrate BW Switch	Auto
	Offset-2 Integrate BW Switch	Auto
	Offset-3 Integrate BW Switch	Auto
	Offset-4 Integrate BW Switch	Auto
	Limit-1 REL Start Level	-31.5 dB
	Limit-2 REL Start Level	-51.5 dB
	Limit-3 REL Start Level	-58.5 dB
	Limit-4 REL Start Level	-81.5 dB *1
	Limit-1 REL Stop Level	-51.5 dB
	Limit-2 REL Stop Level	-58.5 dB
	Limit-3 REL Stop Level	-81.5 dB *1
	Limit-4 REL Stop Level	-81.5 dB *1
	Limit-1 Fail Logic	REL
	Limit-2 Fail Logic	REL
	Limit-3 Fail Logic	REL
	Limit-4 Fail Logic	REL

Table C-5 Standard parameters for Spectrum Emission Mask (Cont'd)

Standard	Parameter Name	Setting
ISDB-Tmm 14.2MHz BW (ABS)	Limit Side	Lower *2
	Noise Cancel	Off
	Reference Mode	Channel
	Channel BW	14.2 MHz
	RBW	10 kHz
	VBW	300 Hz
	Sweep Time	Auto
	Auto Sweep Time Select	Fast
	Detection	Positive
	Trace Point	1001
	Filter Type	Rect
	Offset-1 Start Freq	7.07 MHz
	Offset-2 Start Freq	7.14 MHz
	Offset-3 Start Freq	7.29 MHz
	Offset-4 Start Freq	8.64 MHz
	Offset-5 Start Freq	12.21 MHz
	Offset-1 Stop Freq	7.14 MHz
	Offset-2 Stop Freq	7.29 MHz
	Offset-3 Stop Freq	8.64 MHz
	Offset-4 Stop Freq	12.21 MHz
	Offset-5 Stop Freq	35.45 MHz
	Offset-1 Reference Level	Auto
	Offset-2 Reference Level	Auto
	Offset-3 Reference Level	Auto
	Offset-4 Reference Level	Auto
	Offset-5 Reference Level	Auto
	Offset-1 RBW	10 kHz
	Offset-2 RBW	10 kHz
	Offset-3 RBW	10 kHz
	Offset-4 RBW	10 kHz
	Offset-5 RBW	10 kHz
	Offset-1 VBW	300 Hz
Offset-2 VBW	300 Hz	
Offset-3 VBW	300 Hz	
Offset-4 VBW	300 Hz	
Offset-5 VBW	300 Hz	

Table C-5 Standard parameters for Spectrum Emission Mask (Cont'd)

Standard	Parameter Name	Setting
ISDB-Tmm 14.2MHz BW (ABS)	Offset-1 SweepTime	Auto
	Offset-2 SweepTime	Auto
	Offset-3 SweepTime	Auto
	Offset-4 SweepTime	Auto
	Offset-5 SweepTime	Auto
	Offset-1 Auto Sweep Time Select	Fast
	Offset-2 Auto Sweep Time Select	Fast
	Offset-3 Auto Sweep Time Select	Fast
	Offset-4 Auto Sweep Time Select	Fast
	Offset-5 Auto Sweep Time Select	Fast
	Offset-1 Detection	Positive
	Offset-2 Detection	Positive
	Offset-3 Detection	Positive
	Offset-4 Detection	Positive
	Offset-5 Detection	Positive
	Offset-1 TracePoint	1001
	Offset-2 TracePoint	1001
	Offset-3 TracePoint	1001
	Offset-4 TracePoint	1001
	Offset-5 TracePoint	1001
	Offset-1 Integrate BW Switch	Auto
	Offset-2 Integrate BW Switch	Auto
	Offset-3 Integrate BW Switch	Auto
	Offset-4 Integrate BW Switch	Auto
	Offset-5 Integrate BW Switch	Auto
	Limit-1 REL Start Level	-31.5 dB
	Limit-2 REL Start Level	-51.5 dB
	Limit-3 REL Start Level	-58.5 dB
	Limit-4 REL Start Level	-81.5 dB *1
	Limit-5 REL Start Level	-81.5 dB *1
	Limit-1 REL Stop Level	-51.5 dB
	Limit-2 REL Stop Level	-58.5 dB
Limit-3 REL Stop Level	-81.5 dB *1	
Limit-4 REL Stop Level	-81.5 dB *1	
Limit-5 REL Stop Level	-81.5 dB *1	

Table C-5 Standard parameters for Spectrum Emission Mask (Cont'd)

Standard	Parameter Name	Setting
ISDB-Tmm 14.2MHz BW (ABS)	Limit-1 Fail Logic	Off *2
	Limit-2 Fail Logic	Off *2
	Limit-3 Fail Logic	Off *2
	Limit-4 Fail Logic	Off *2
	Limit-5 Fail Logic	ABS1 and REL
	Limit-5 ABS1 Start Level	-32.4 dBm *3
	Limit-5 ABS1 Stop Level	-32.4 dBm *3

*1 Value when antenna power exceeds $2.5 \times 33/13$ W. The value for each antenna power can be calculated using the following formula (source: ARIB STD-B46 1.1). Antenna power P in Watts.

Antenna Power [W]	Setting [dB]
$P > 2.5 \times 33/13$	-81.5
$2.5 \times 33/13 \geq P > 0.025 \times 33/13$	$-(73.4 + 10 \log (P))$
$0.025 \times 33/13 \geq P$	-57.4
Rounded down to two decimal places. $2.5 \times 33/13 \approx 6.35$ [W], $0.025 \times 33/13 \approx 63.5$ [mW]	

*2 When measuring relative level mask simultaneously, set Limit Side to Both, and Fail Logic to REL. However, in this case, the Limit -5 absolute level mask is symmetrical on the left and right sides.

*3 Value when antenna power exceeds 1000/6 (W/MHz) (about 2.37 kW at 14.2 MHz conversion). The value for each antenna power can be calculated using the following formula (source: ARIB STD-B46 1.1).

Antenna Power [W/MHz]	Upper Limit (dBm) of Antenna Power at 202.5 MHz
$P > 1000/6$	-32.4
$1000/6 \geq P > 100/6$	$10 \log (P) - 55$
$100/6 \geq P$	-42.4
Here, P is the average power (W/MHz) of the fundamental frequency.	

Table C-5 Standard parameters for Spectrum Emission Mask (Cont'd)

Standard	Parameter Name	Setting
ISDB-Tmm (ISDB-T) 5.6MHz BW	Limit Side	Both
	Noise Cancel	Off
	Reference Mode	Channel
	Channel BW	5.6 MHz
	RBW	10 kHz
	VBW	300 Hz
	Sweep Time	Auto
	Auto Sweep Time Select	Fast
	Detection	Positive
	Trace Point	1001
	Filter Type	Rect
	Offset-1 Start Freq	2.79 MHz
	Offset-2 Start Freq	2.86 MHz
	Offset-3 Start Freq	3.00 MHz
	Offset-4 Start Freq	4.36 MHz
	Offset-1 Stop Freq	2.86 MHz
	Offset-2 Stop Freq	3.00 MHz
	Offset-3 Stop Freq	4.36 MHz
	Offset-4 Stop Freq	15 MHz
	Offset-1 Reference Level	Auto
	Offset-2 Reference Level	Auto
	Offset-3 Reference Level	Auto
	Offset-4 Reference Level	Auto
	Offset-1 RBW	10 kHz
	Offset-2 RBW	10 kHz
	Offset-3 RBW	10 kHz
	Offset-4 RBW	10 kHz
	Offset-1 VBW	300 Hz
Offset-2 VBW	300 Hz	
Offset-3 VBW	300 Hz	
Offset-4 VBW	300 Hz	

Table C-5 Standard parameters for Spectrum Emission Mask (Cont'd)

Standard	Parameter Name	Setting
ISDB-Tmm (ISDB-T) 5.6MHz BW	Offset-1 SweepTime	Auto
	Offset-2 SweepTime	Auto
	Offset-3 SweepTime	Auto
	Offset-4 SweepTime	Auto
	Offset-1 Auto Sweep Time Select	Fast
	Offset-2 Auto Sweep Time Select	Fast
	Offset-3 Auto Sweep Time Select	Fast
	Offset-4 Auto Sweep Time Select	Fast
	Offset-1 Detection	Positive
	Offset-2 Detection	Positive
	Offset-3 Detection	Positive
	Offset-4 Detection	Positive
	Offset-1 TracePoint	1001
	Offset-2 TracePoint	1001
	Offset-3 TracePoint	1001
	Offset-4 TracePoint	1001
	Offset-1 Integrate BW Switch	Auto
	Offset-2 Integrate BW Switch	Auto
	Offset-3 Integrate BW Switch	Auto
	Offset-4 Integrate BW Switch	Auto
	Limit-1 REL Start Level	-27.4 dB
	Limit-2 REL Start Level	-47.4 dB
	Limit-3 REL Start Level	-54.4 dB
	Limit-4 REL Start Level	-77.4 dB
	Limit-1 REL Stop Level	-47.4 dB
	Limit-2 REL Stop Level	-54.4 dB
	Limit-3 REL Stop Level	-77.4 dB
	Limit-4 REL Stop Level	-77.4 dB
	Limit-1 Fail Logic	REL
	Limit-2 Fail Logic	REL
	Limit-3 Fail Logic	REL
	Limit-4 Fail Logic	REL

ISDB-T

Table C-5 Standard parameters for Spectrum Emission Mask (Cont'd)

Standard	Parameter Name	Setting
ISDB-T 5.6MHz BW	Limit Side	Both
	Noise Cancel	Off
	Reference Mode	Channel
	Channel BW	5.6 MHz
	RBW	10 kHz
	VBW	300 Hz
	Sweep Time	Auto
	Auto Sweep Time Select	Fast
	Detection	Positive
	Trace Point	1001
	Filter Type	Rect
	Offset-1 Start Freq	2.79 MHz
	Offset-2 Start Freq	2.86 MHz
	Offset-3 Start Freq	3.00 MHz
	Offset-4 Start Freq	4.36 MHz
	Offset-1 Stop Freq	2.86 MHz
	Offset-2 Stop Freq	3.00 MHz
	Offset-3 Stop Freq	4.36 MHz
	Offset-4 Stop Freq	15 MHz
	Offset-1 Reference Level	Auto
	Offset-2 Reference Level	Auto
	Offset-3 Reference Level	Auto
	Offset-4 Reference Level	Auto
	Offset-1 RBW	10 kHz
	Offset-2 RBW	10 kHz
	Offset-3 RBW	10 kHz
	Offset-4 RBW	10 kHz
	Offset-1 VBW	300 Hz
Offset-2 VBW	300 Hz	
Offset-3 VBW	300 Hz	
Offset-4 VBW	300 Hz	

Table C-5 Standard parameters for Spectrum Emission Mask (Cont'd)

Standard	Parameter Name	Setting
ISDB-T 5.6MHz BW	Offset-1 SweepTime	Auto
	Offset-2 SweepTime	Auto
	Offset-3 SweepTime	Auto
	Offset-4 SweepTime	Auto
	Offset-1 Auto Sweep Time Select	Fast
	Offset-2 Auto Sweep Time Select	Fast
	Offset-3 Auto Sweep Time Select	Fast
	Offset-4 Auto Sweep Time Select	Fast
	Offset-1 Detection	Positive
	Offset-2 Detection	Positive
	Offset-3 Detection	Positive
	Offset-4 Detection	Positive
	Offset-1 TracePoint	1001
	Offset-2 TracePoint	1001
	Offset-3 TracePoint	1001
	Offset-4 TracePoint	1001
	Offset-1 Integrate BW Switch	Auto
	Offset-2 Integrate BW Switch	Auto
	Offset-3 Integrate BW Switch	Auto
	Offset-4 Integrate BW Switch	Auto
	Limit-1 REL Start Level	-27.4 dB
	Limit-2 REL Start Level	-47.4 dB
	Limit-3 REL Start Level	-54.4 dB
	Limit-4 REL Start Level	-77.4 dB
	Limit-1 REL Stop Level	-47.4 dB
	Limit-2 REL Stop Level	-54.4 dB
	Limit-3 REL Stop Level	-77.4 dB
	Limit-4 REL Stop Level	-77.4 dB
	Limit-1 Fail Logic	REL
	Limit-2 Fail Logic	REL
	Limit-3 Fail Logic	REL
	Limit-4 Fail Logic	REL

ISDB-T_{SB}

Table C-5 Standard parameters for Spectrum Emission Mask (Cont'd)

Standard	Parameter Name	Setting
ISDB-T _{SB} 3.9MHz BW	Limit Side	Both
	Noise Cancel	Off
	Reference Mode	Channel
	Channel BW	3.9 MHz
	RBW	10 kHz
	VBW	300 Hz
	Sweep Time	Auto
	Auto Sweep Time Select	Fast
	Detection	Positive
	Trace Point	1001
	Filter Type	Rect
	Offset-1 Start Freq	1.93 MHz
	Offset-2 Start Freq	2.01 MHz
	Offset-3 Start Freq	2.08 MHz
	Offset-4 Start Freq	3.51 MHz
	Offset-1 Stop Freq	2.01 MHz
	Offset-2 Stop Freq	2.08 MHz
	Offset-3 Stop Freq	3.51 MHz
	Offset-4 Stop Freq	9.74 MHz
	Offset-1 Reference Level	Auto
	Offset-2 Reference Level	Auto
	Offset-3 Reference Level	Auto
	Offset-4 Reference Level	Auto
	Offset-1 RBW	10 kHz
	Offset-2 RBW	10 kHz
	Offset-3 RBW	10 kHz
	Offset-4 RBW	10 kHz
	Offset-1 VBW	300 Hz
	Offset-2 VBW	300 Hz
	Offset-3 VBW	300 Hz
Offset-4 VBW	300 Hz	

Table C-5 Standard parameters for Spectrum Emission Mask (Cont'd)

Standard	Parameter Name	Setting
ISDB-T _{SB} 3.9MHz BW	Offset-1 SweepTime	Auto
	Offset-2 SweepTime	Auto
	Offset-3 SweepTime	Auto
	Offset-4 SweepTime	Auto
	Offset-1 Auto Sweep Time Select	Fast
	Offset-2 Auto Sweep Time Select	Fast
	Offset-3 Auto Sweep Time Select	Fast
	Offset-4 Auto Sweep Time Select	Fast
	Offset-1 Detection	Positive
	Offset-2 Detection	Positive
	Offset-3 Detection	Positive
	Offset-4 Detection	Positive
	Offset-1 TracePoint	1001
	Offset-2 TracePoint	1001
	Offset-3 TracePoint	1001
	Offset-4 TracePoint	1001
	Offset-1 Integrate BW Switch	Auto
	Offset-2 Integrate BW Switch	Auto
	Offset-3 Integrate BW Switch	Auto
	Offset-4 Integrate BW Switch	Auto
	Limit-1 REL Start Level	-25.9 dB
	Limit-2 REL Start Level	-45.9 dB
	Limit-3 REL Start Level	-55.9 dB
	Limit-4 REL Start Level	-75.9 dB*4
	Limit-1 REL Stop Level	-45.9 dB
	Limit-2 REL Stop Level	-55.9 dB
	Limit-3 REL Stop Level	-75.9 dB*4
	Limit-4 REL Stop Level	-75.9 dB*4
	Limit-1 Fail Logic	REL
	Limit-2 Fail Logic	REL
	Limit-3 Fail Logic	REL
	Limit-4 Fail Logic	REL

- *4 Value when antenna power exceeds 5 W. The value for each antenna power can be calculated using the following formula (source: ARIB STD-B46 2.0). Antenna power P in Watts.

Antenna Power [W]	Setting [dB]
$P > 5$	-75.9
$5 \geq P > 0.5$	$-(10\log(6000/14 \times 9/10) + 43 + 10\log(P))$
$0.5 \geq P$	$-(40 + 10\log(6000/14 \times 9/10))$
Rounded down to two decimal places.	

SEM 802.11a

Table C-5 Standard parameters for Spectrum Emission Mask (Cont'd)

Standard	Parameter Name	Setting
SEM 802.11a BW_20MHz (WLAN) (IEEE 802.11-2012)	Limit Side	Both
	Noise Cancel	Off
	Reference Mode	Peak
	Channel BW	18 MHz
	RBW	100 kHz
	VBW	30 kHz
	Sweep Time	Auto
	Auto Sweep Time Select	Fast
	Detection	RMS
	Trace Point	1001
	Filter Type	Rect
	Offset-1 Start Freq	9 MHz
	Offset-2 Start Freq	11 MHz
	Offset-3 Start Freq	20 MHz
	Offset-4 Start Freq	30 MHz
	Offset-1 Stop Freq	11 MHz
	Offset-2 Stop Freq	20 MHz
	Offset-3 Stop Freq	30 MHz
	Offset-4 Stop Freq	50 MHz
	Offset-1 Reference Level	Auto
	Offset-2 Reference Level	Auto
	Offset-3 Reference Level	Auto
	Offset-4 Reference Level	Auto
	Offset-1 RBW	100 kHz
	Offset-2 RBW	100 kHz
	Offset-3 RBW	100 kHz
	Offset-4 RBW	100 kHz
	Offset-1 VBW	30 kHz
	Offset-2 VBW	30 kHz
	Offset-3 VBW	30 kHz
	Offset-4 VBW	30 kHz
	Offset-1 Sweep Time	Auto
Offset-2 Sweep Time	Auto	
Offset-3 Sweep Time	Auto	
Offset-4 Sweep Time	Auto	

Table C-5 Standard parameters for Spectrum Emission Mask (Cont'd)

Standard	Parameter Name	Setting
SEM 802.11a BW_20MHz (WLAN) (IEEE 802.11-2012)	Offset-1 Auto Sweep Time Select	Fast
	Offset-2 Auto Sweep Time Select	Fast
	Offset-3 Auto Sweep Time Select	Fast
	Offset-4 Auto Sweep Time Select	Fast
	Offset-1 Detection	RMS
	Offset-2 Detection	RMS
	Offset-3 Detection	RMS
	Offset-4 Detection	RMS
	Offset-1 Trace Point	1001
	Offset-2 Trace Point	1001
	Offset-3 Trace Point	1001
	Offset-4 Trace Point	1001
	Offset-1 Integrate BW	Auto
	Offset-2 Integrate BW	Auto
	Offset-3 Integrate BW	Auto
	Offset-4 Integrate BW	Auto
	Offset-1 On/Off	On
	Offset-2 On/Off	On
	Offset-3 On/Off	On
	Offset-4 On/Off	On
	Offset-5 On/Off	Off
	Offset-6 On/Off	Off
	Limit-1 REL Start Level	0.0 dB
	Limit-2 REL Start Level	-20.0 dB
	Limit-3 REL Start Level	-28.0 dB
	Limit-4 REL Start Level	-40.0 dB
	Limit-1 REL Stop Level	-20.0 dB
	Limit-2 REL Stop Level	-28.0 dB
	Limit-3 REL Stop Level	-40.0 dB
	Limit-4 REL Stop Level	-40.0 dB
	Limit-1 Fail Logic	REL
	Limit-2 Fail Logic	REL
Limit-3 Fail Logic	REL	
Limit-4 Fail Logic	REL	

SEM 802.11b

Table C-5 Standard parameters for Spectrum Emission Mask (Cont'd)

Standard	Parameter Name	Setting
SEM 802.11b DSSS/CCK (WLAN) (IEEE 802.11-2012)	Limit Side	Both
	Noise Cancel	Off
	Reference Mode	Peak
	Channel BW	22 MHz
	RBW	100 kHz
	VBW	30 kHz
	Sweep Time	Auto
	Auto Sweep Time Select	Fast
	Detection	RMS
	Trace Point	1001
	Filter Type	Rect
	Offset-1 Start Freq	11 MHz
	Offset-2 Start Freq	22 MHz
	Offset-1 Stop Freq	22 MHz
	Offset-2 Stop Freq	30 MHz
	Offset-1 Reference Level	Auto
	Offset-2 Reference Level	Auto
	Offset-1 RBW	100 kHz
	Offset-2 RBW	100 kHz
	Offset-1 VBW	30 kHz
	Offset-2 VBW	30 kHz
	Offset-1 Sweep Time	Auto
	Offset-2 Sweep Time	Auto
	Offset-1 Auto Sweep Time Select	Fast
	Offset-2 Auto Sweep Time Select	Fast
	Offset-1 Detection	RMS
	Offset-2 Detection	RMS
	Offset-1 Trace Point	1001
	Offset-2 Trace Point	1001
	Offset-1 Integrate BW	Auto
Offset-2 Integrate BW	Auto	

Table C-5 Standard parameters for Spectrum Emission Mask (Cont'd)

Standard	Parameter Name	Setting
SEM 802.11b DSSS/CCK (WLAN) (IEEE 802.11-2012)	Offset-1 On/Off	On
	Offset-2 On/Off	On
	Offset-3 On/Off	Off
	Offset-4 On/Off	Off
	Offset-5 On/Off	Off
	Offset-6 On/Off	Off
	Limit-1 REL Start Level	-30.0 dB
	Limit-2 REL Start Level	-50.0 dB
	Limit-1 REL Stop Level	-30.0 dB
	Limit-2 REL Stop Level	-50.0 dB
	Limit-1 Fail Logic	REL
	Limit-2 Fail Logic	REL

SEM 802.11g

Table C-5 Standard parameters for Spectrum Emission Mask (Cont'd)

Standard	Parameter Name	Setting
SEM 802.11g OFDM (WLAN) (IEEE 802.11-2012)	Limit Side	Both
	Noise Cancel	Off
	Reference Mode	Peak
	Channel BW	18 MHz
	RBW	100 kHz
	VBW	30 kHz
	Sweep Time	Auto
	Auto Sweep Time Select	Fast
	Detection	RMS
	Trace Point	1001
	Filter Type	Rect
	Offset-1 Start Freq	9 MHz
	Offset-2 Start Freq	11 MHz
	Offset-3 Start Freq	20 MHz
	Offset-4 Start Freq	30 MHz
	Offset-1 Stop Freq	11 MHz
	Offset-2 Stop Freq	20 MHz
	Offset-3 Stop Freq	30 MHz
	Offset-4 Stop Freq	50 MHz
	Offset-1 Reference Level	Auto
	Offset-2 Reference Level	Auto
	Offset-3 Reference Level	Auto
	Offset-4 Reference Level	Auto
	Offset-1 RBW	100 kHz
	Offset-2 RBW	100 kHz
	Offset-3 RBW	100 kHz
	Offset-4 RBW	100 kHz
	Offset-1 VBW	30 kHz
	Offset-2 VBW	30 kHz
	Offset-3 VBW	30 kHz
	Offset-4 VBW	30 kHz
	Offset-1 Sweep Time	Auto
Offset-2 Sweep Time	Auto	
Offset-3 Sweep Time	Auto	
Offset-4 Sweep Time	Auto	

Table C-5 Standard parameters for Spectrum Emission Mask (Cont'd)

Standard	Parameter Name	Setting
SEM 802.11g OFDM (WLAN) (IEEE 802.11-2012)	Offset-1 Auto Sweep Time Select	Fast
	Offset-2 Auto Sweep Time Select	Fast
	Offset-3 Auto Sweep Time Select	Fast
	Offset-4 Auto Sweep Time Select	Fast
	Offset-1 Detection	RMS
	Offset-2 Detection	RMS
	Offset-3 Detection	RMS
	Offset-4 Detection	RMS
	Offset-1 Trace Point	1001
	Offset-2 Trace Point	1001
	Offset-3 Trace Point	1001
	Offset-4 Trace Point	1001
	Offset-1 Integrate BW	Auto
	Offset-2 Integrate BW	Auto
	Offset-3 Integrate BW	Auto
	Offset-4 Integrate BW	Auto
	Offset-1 On/Off	On
	Offset-2 On/Off	On
	Offset-3 On/Off	On
	Offset-4 On/Off	On
	Offset-5 On/Off	Off
	Offset-6 On/Off	Off
	Limit-1 REL Start Level	0.0 dB
	Limit-2 REL Start Level	-20.0 dB
	Limit-3 REL Start Level	-28.0 dB
	Limit-4 REL Start Level	-40.0 dB
	Limit-1 REL Stop Level	-20.0 dB
	Limit-2 REL Stop Level	-28.0 dB
	Limit-3 REL Stop Level	-40.0 dB
	Limit-4 REL Stop Level	-40.0 dB
	Limit-1 Fail Logic	REL
	Limit-2 Fail Logic	REL
Limit-3 Fail Logic	REL	
Limit-4 Fail Logic	REL	

Table C-5 Standard parameters for Spectrum Emission Mask (Cont'd)

Standard	Parameter Name	Setting
SEM 802.11g DSSS/CCK (WLAN) (IEEE 802.11-2012)	Limit Side	Both
	Noise Cancel	Off
	Reference Mode	Peak
	Channel BW	22 MHz
	RBW	100 kHz
	VBW	30 kHz
	Sweep Time	Auto
	Auto Sweep Time Select	Fast
	Detection	RMS
	Trace Point	1001
	Filter Type	Rect
	Offset-1 Start Freq	11 MHz
	Offset-2 Start Freq	22 MHz
	Offset-1 Stop Freq	22 MHz
	Offset-2 Stop Freq	30 MHz
	Offset-1 Reference Level	Auto
	Offset-2 Reference Level	Auto
	Offset-1 RBW	100 kHz
	Offset-2 RBW	100 kHz
	Offset-1 VBW	30 kHz
	Offset-2 VBW	30 kHz
	Offset-1 Sweep Time	Auto
	Offset-2 Sweep Time	Auto
	Offset-1 Auto Sweep Time Select	Fast
	Offset-2 Auto Sweep Time Select	Fast
	Offset-1 Detection	RMS
	Offset-2 Detection	RMS
	Offset-1 Trace Point	1001
Offset-2 Trace Point	1001	
Offset-1 Integrate BW	Auto	
Offset-2 Integrate BW	Auto	

Table C-5 Standard parameters for Spectrum Emission Mask (Cont'd)

Standard	Parameter Name	Setting
SEM 802.11g DSSS/CCK (WLAN) (IEEE 802.11-2012)	Offset-1 On/Off	On
	Offset-2 On/Off	On
	Offset-3 On/Off	Off
	Offset-4 On/Off	Off
	Offset-5 On/Off	Off
	Offset-6 On/Off	Off
	Limit-1 REL Start Level	-30.0 dB
	Limit-2 REL Start Level	-50.0 dB
	Limit-1 REL Stop Level	-30.0 dB
	Limit-2 REL Stop Level	-50.0 dB
	Limit-1 Fail Logic	REL
	Limit-2 Fail Logic	REL

Table C-5 Standard parameters for Spectrum Emission Mask (Cont'd)

Standard	Parameter Name	Setting
SEM 802.11g DSSS-OFDM (WLAN) (IEEE 802.11-2012)	Limit Side	Both
	Noise Cancel	Off
	Reference Mode	Peak
	Channel BW	18 MHz
	RBW	100 kHz
	VBW	30 kHz
	Sweep Time	Auto
	Auto Sweep Time Select	Fast
	Detection	RMS
	Trace Point	1001
	Filter Type	Rect
	Offset-1 Start Freq	9 MHz
	Offset-2 Start Freq	11 MHz
	Offset-3 Start Freq	20 MHz
	Offset-4 Start Freq	30 MHz
	Offset-1 Stop Freq	11 MHz
	Offset-2 Stop Freq	20 MHz
	Offset-3 Stop Freq	30 MHz
	Offset-4 Stop Freq	50 MHz
	Offset-1 Reference Level	Auto
	Offset-2 Reference Level	Auto
	Offset-3 Reference Level	Auto
	Offset-4 Reference Level	Auto
	Offset-1 RBW	100 kHz
	Offset-2 RBW	100 kHz
	Offset-3 RBW	100 kHz
	Offset-4 RBW	100 kHz
	Offset-1 VBW	30 kHz
	Offset-2 VBW	30 kHz
	Offset-3 VBW	30 kHz
	Offset-4 VBW	30 kHz
	Offset-1 Sweep Time	Auto
Offset-2 Sweep Time	Auto	
Offset-3 Sweep Time	Auto	
Offset-4 Sweep Time	Auto	

Table C-5 Standard parameters for Spectrum Emission Mask (Cont'd)

Standard	Parameter Name	Setting
SEM 802.11g DSSS-OFDM (WLAN) (IEEE 802.11-2012)	Offset-1 Auto Sweep Time Select	Fast
	Offset-2 Auto Sweep Time Select	Fast
	Offset-3 Auto Sweep Time Select	Fast
	Offset-4 Auto Sweep Time Select	Fast
	Offset-1 Detection	RMS
	Offset-2 Detection	RMS
	Offset-3 Detection	RMS
	Offset-4 Detection	RMS
	Offset-1 Trace Point	1001
	Offset-2 Trace Point	1001
	Offset-3 Trace Point	1001
	Offset-4 Trace Point	1001
	Offset-1 Integrate BW	Auto
	Offset-2 Integrate BW	Auto
	Offset-3 Integrate BW	Auto
	Offset-4 Integrate BW	Auto
	Offset-1 On/Off	On
	Offset-2 On/Off	On
	Offset-3 On/Off	On
	Offset-4 On/Off	On
	Offset-5 On/Off	Off
	Offset-6 On/Off	Off
	Limit-1 REL Start Level	0.0 dB
	Limit-2 REL Start Level	-20.0 dB
	Limit-3 REL Start Level	-28.0 dB
	Limit-4 REL Start Level	-40.0 dB
	Limit-1 REL Stop Level	-20.0 dB
	Limit-2 REL Stop Level	-28.0 dB
	Limit-3 REL Stop Level	-40.0 dB
	Limit-4 REL Stop Level	-40.0 dB
	Limit-1 Fail Logic	REL
	Limit-2 Fail Logic	REL
Limit-3 Fail Logic	REL	
Limit-4 Fail Logic	REL	

SEM 802.11j

Table C-5 Standard parameters for Spectrum Emission Mask (Cont'd)

Standard	Parameter Name	Setting
SEM 802.11j BW_10MHz (WLAN) (IEEE 802.11-2007)	Limit Side	Both
	Noise Cancel	Off
	Reference Mode	Peak
	Channel BW	9 MHz
	RBW	100 kHz
	VBW	30 kHz
	Sweep Time	Auto
	Auto Sweep Time Select	Fast
	Detection	RMS
	Trace Point	1001
	Filter Type	Rect
	Offset-1 Start Freq	4.5 MHz
	Offset-2 Start Freq	5.5 MHz
	Offset-3 Start Freq	10 MHz
	Offset-4 Start Freq	15 MHz
	Offset-1 Stop Freq	5.5 MHz
	Offset-2 Stop Freq	10 MHz
	Offset-3 Stop Freq	15 MHz
	Offset-4 Stop Freq	25 MHz
	Offset-1 Reference Level	Auto
	Offset-2 Reference Level	Auto
	Offset-3 Reference Level	Auto
	Offset-4 Reference Level	Auto
	Offset-1 RBW	100 kHz
	Offset-2 RBW	100 kHz
	Offset-3 RBW	100 kHz
	Offset-4 RBW	100 kHz
	Offset-1 VBW	30 kHz
	Offset-2 VBW	30 kHz
	Offset-3 VBW	30 kHz
	Offset-4 VBW	30 kHz
	Offset-1 Sweep Time	Auto
Offset-2 Sweep Time	Auto	
Offset-3 Sweep Time	Auto	
Offset-4 Sweep Time	Auto	

Table C-5 Standard parameters for Spectrum Emission Mask (Cont'd)

Standard	Parameter Name	Setting
SEM 802.11j BW_10MHz (WLAN) (IEEE 802.11-2007)	Offset-1 Auto Sweep Time Select	Fast
	Offset-2 Auto Sweep Time Select	Fast
	Offset-3 Auto Sweep Time Select	Fast
	Offset-4 Auto Sweep Time Select	Fast
	Offset-1 Detection	RMS
	Offset-2 Detection	RMS
	Offset-3 Detection	RMS
	Offset-4 Detection	RMS
	Offset-1 Trace Point	1001
	Offset-2 Trace Point	1001
	Offset-3 Trace Point	1001
	Offset-4 Trace Point	1001
	Offset-1 Integrate BW	Auto
	Offset-2 Integrate BW	Auto
	Offset-3 Integrate BW	Auto
	Offset-4 Integrate BW	Auto
	Offset-1 On/Off	On
	Offset-2 On/Off	On
	Offset-3 On/Off	On
	Offset-4 On/Off	On
	Offset-5 On/Off	Off
	Offset-6 On/Off	Off
	Limit-1 REL Start Level	0.0 dB
	Limit-2 REL Start Level	-20.0 dB
	Limit-3 REL Start Level	-28.0 dB
	Limit-4 REL Start Level	-40.0 dB
	Limit-1 REL Stop Level	-20.0 dB
	Limit-2 REL Stop Level	-28.0 dB
	Limit-3 REL Stop Level	-40.0 dB
	Limit-4 REL Stop Level	-40.0 dB
	Limit-1 Fail Logic	REL
	Limit-2 Fail Logic	REL
Limit --3 Fail Logic	REL	
Limit-4 Fail Logic	REL	

SEM 802.11p

Table C-5 Standard parameters for Spectrum Emission Mask (Cont'd)

Standard	Parameter Name	Setting
SEM 802.11p BW_10MHz (WLAN) (IEEE 802.11-2007)	Limit Side	Both
	Noise Cancel	Off
	Reference Mode	Peak
	Channel BW	9 MHz
	RBW	100 kHz
	VBW	30 kHz
	Sweep Time	Auto
	Auto Sweep Time Select	Fast
	Detection	RMS
	Trace Point	1001
	Filter Type	Rect
	Offset-1 Start Freq	4.5 MHz
	Offset-2 Start Freq	5.5 MHz
	Offset-3 Start Freq	10 MHz
	Offset-4 Start Freq	15 MHz
	Offset-1 Stop Freq	5.5 MHz
	Offset-2 Stop Freq	10 MHz
	Offset-3 Stop Freq	15 MHz
	Offset-4 Stop Freq	25 MHz
	Offset-1 Reference Level	Auto
	Offset-2 Reference Level	Auto
	Offset-3 Reference Level	Auto
	Offset-4 Reference Level	Auto
	Offset-1 RBW	100 kHz
	Offset-2 RBW	100 kHz
	Offset-3 RBW	100 kHz
	Offset-4 RBW	100 kHz
	Offset-1 VBW	30 kHz
	Offset-2 VBW	30 kHz
	Offset-3 VBW	30 kHz
	Offset-4 VBW	30 kHz
	Offset-1 Sweep Time	Auto
Offset-2 Sweep Time	Auto	
Offset-3 Sweep Time	Auto	
Offset-4 Sweep Time	Auto	

Table C-5 Standard parameters for Spectrum Emission Mask (Cont'd)

Standard	Parameter Name	Setting
SEM 802.11p BW_10MHz (WLAN) (IEEE 802.11-2007)	Offset-1 Auto Sweep Time Select	Fast
	Offset-2 Auto Sweep Time Select	Fast
	Offset-3 Auto Sweep Time Select	Fast
	Offset-4 Auto Sweep Time Select	Fast
	Offset-1 Detection	RMS
	Offset-2 Detection	RMS
	Offset-3 Detection	RMS
	Offset-4 Detection	RMS
	Offset-1 Trace Point	1001
	Offset-2 Trace Point	1001
	Offset-3 Trace Point	1001
	Offset-4 Trace Point	1001
	Offset-1 Integrate BW	Auto
	Offset-2 Integrate BW	Auto
	Offset-3 Integrate BW	Auto
	Offset-4 Integrate BW	Auto
	Offset-1 On/Off	On
	Offset-2 On/Off	On
	Offset-3 On/Off	On
	Offset-4 On/Off	On
	Offset-5 On/Off	Off
	Offset-6 On/Off	Off
	Limit-1 REL Start Level	0.0 dB
	Limit-2 REL Start Level	-20.0 dB
	Limit-3 REL Start Level	-28.0 dB
	Limit-4 REL Start Level	-40.0 dB
	Limit-1 REL Stop Level	-20.0 dB
	Limit-2 REL Stop Level	-28.0 dB
	Limit-3 REL Stop Level	-40.0 dB
	Limit-4 REL Stop Level	-40.0 dB
	Limit-1 Fail Logic	REL
	Limit-2 Fail Logic	REL
Limit-3 Fail Logic	REL	
Limit-4 Fail Logic	REL	

SEM 802.11n

Table C-5 Standard parameters for Spectrum Emission Mask (Cont'd)

Standard	Parameter Name	Setting
SEM 802.11n BW_20MHz (2.4GHz) (WLAN) (IEEE 802.11-2012)	Limit Side	Both
	Noise Cancel	Off
	Reference Mode	Peak
	Channel BW	18 MHz
	RBW	100 kHz
	Sweep Time	Auto
	Auto Sweep Time Select	Fast
	Detection	RMS
	Trace Point	1001
	Filter Type	Rect
	Offset-1 Start Freq	9 MHz
	Offset-2 Start Freq	11 MHz
	Offset-3 Start Freq	20 MHz
	Offset-4 Start Freq	30 MHz
	Offset-5 Start Freq	30 MHz
	Offset-1 Stop Freq	11 MHz
	Offset-2 Stop Freq	20 MHz
	Offset-3 Stop Freq	30 MHz
	Offset-4 Stop Freq	50 MHz
	Offset-1 Reference Level	Auto
	Offset-2 Reference Level	Auto
	Offset-3 Reference Level	Auto
	Offset-4 Reference Level	Auto
	Offset-1 RBW	100 kHz
	Offset-2 RBW	100 kHz
	Offset-3 RBW	100 kHz
	Offset-4 RBW	100 kHz
	Offset-1 Sweep Time	Auto
	Offset-2 Sweep Time	Auto
	Offset-3 Sweep Time	Auto
	Offset-4 Sweep Time	Auto
	Offset-1 Auto Sweep Time Select	Fast
Offset-2 Auto Sweep Time Select	Fast	
Offset-3 Auto Sweep Time Select	Fast	
Offset-4 Auto Sweep Time Select	Fast	

Table C-5 Standard parameters for Spectrum Emission Mask (Cont'd)

Standard	Parameter Name	Setting
SEM 802.11n BW_20MHz (2.4GHz) (WLAN) (IEEE 802.11-2012)	Offset-1 Detection	RMS
	Offset-2 Detection	RMS
	Offset-3 Detection	RMS
	Offset-4 Detection	RMS
	Offset-1 Trace Point	1001
	Offset-2 Trace Point	1001
	Offset-3 Trace Point	1001
	Offset-4 Trace Point	1001
	Offset-1 Integrate BW	Auto
	Offset-2 Integrate BW	Auto
	Offset-3 Integrate BW	Auto
	Offset-4 Integrate BW	Auto
	Offset-1 On/Off	On
	Offset-2 On/Off	On
	Offset-3 On/Off	On
	Offset-4 On/Off	On
	Limit-1 REL Start Level	0.0 dB
	Limit-2 REL Start Level	-20.0 dB
	Limit-3 REL Start Level	-28.0 dB
	Limit-4 REL Start Level	-45.0 dB
	Limit-1 REL Stop Level	-20.0 dB
	Limit-2 REL Stop Level	-28.0 dB
	Limit-3 REL Stop Level	-45.0 dB
	Limit-4 REL Stop Level	-45.0 dB
	Limit-1 Fail Logic	REL
	Limit-2 Fail Logic	REL
	Limit-3 Fail Logic	REL
	Limit-4 Fail Logic	REL

Table C-5 Standard parameters for Spectrum Emission Mask (Cont'd)

Standard	Parameter Name	Setting
SEM 802.11n BW_20MHz (5GHz) (WLAN) (IEEE 802.11-2012)	Limit Side	Both
	Noise Cancel	Off
	Reference Mode	Peak
	Channel BW	18 MHz
	RBW	100 kHz
	Sweep Time	Auto
	Auto Sweep Time Select	Fast
	Detection	RMS
	Trace Point	1001
	Filter Type	Rect
	Offset-1 Start Freq	9 MHz
	Offset-2 Start Freq	11 MHz
	Offset-3 Start Freq	20 MHz
	Offset-4 Start Freq	30 MHz
	Offset-1 Stop Freq	11 MHz
	Offset-2 Stop Freq	20 MHz
	Offset-3 Stop Freq	30 MHz
	Offset-4 Stop Freq	50 MHz
	Offset-1 Reference Level	Auto
	Offset-2 Reference Level	Auto
	Offset-3 Reference Level	Auto
	Offset-4 Reference Level	Auto
	Offset-1 RBW	100 kHz
	Offset-2 RBW	100 kHz
	Offset-3 RBW	100 kHz
	Offset-4 RBW	100 kHz
	Offset-1 Sweep Time	Auto
	Offset-2 Sweep Time	Auto
	Offset-3 Sweep Time	Auto
	Offset-4 Sweep Time	Auto
	Offset-1 Auto Sweep Time Select	Fast
	Offset-2 Auto Sweep Time Select	Fast
Offset-3 Auto Sweep Time Select	Fast	
Offset-4 Auto Sweep Time Select	Fast	

Table C-5 Standard parameters for Spectrum Emission Mask (Cont'd)

Standard	Parameter Name	Setting
SEM 802.11n BW_20MHz (5GHz) (WLAN) (IEEE 802.11-2012)	Offset-1 Detection	RMS
	Offset-2 Detection	RMS
	Offset-3 Detection	RMS
	Offset-4 Detection	RMS
	Offset-1 Trace Point	1001
	Offset-2 Trace Point	1001
	Offset-3 Trace Point	1001
	Offset-4 Trace Point	1001
	Offset-1 Integrate BW	Auto
	Offset-2 Integrate BW	Auto
	Offset-3 Integrate BW	Auto
	Offset-4 Integrate BW	Auto
	Offset-1 On/Off	On
	Offset-2 On/Off	On
	Offset-3 On/Off	On
	Offset-4 On/Off	On
	Limit-1 REL Start Level	0.0 dB
	Limit-2 REL Start Level	-20.0 dB
	Limit-3 REL Start Level	-28.0 dB
	Limit-4 REL Start Level	-40.0 dB
	Limit-1 REL Stop Level	-20.0 dB
	Limit-2 REL Stop Level	-28.0 dB
	Limit-3 REL Stop Level	-40.0 dB
	Limit-4 REL Stop Level	-40.0 dB
	Limit-1 Fail Logic	REL
	Limit-2 Fail Logic	REL
	Limit-3 Fail Logic	REL
	Limit-4 Fail Logic	REL

Table C-5 Standard parameters for Spectrum Emission Mask (Cont'd)

Standard	Parameter Name	Setting
SEM 802.11n BW_40MHz (2.4GHz) (WLAN) (IEEE 802.11-2012)	Limit Side	Both
	Noise Cancel	Off
	Reference Mode	Peak
	Channel BW	38 MHz
	RBW	100 kHz
	Sweep Time	Auto
	Auto Sweep Time Select	Fast
	Detection	RMS
	Trace Point	1001
	Filter Type	Rect
	Offset-1 Start Freq	19 MHz
	Offset-2 Start Freq	21 MHz
	Offset-3 Start Freq	40 MHz
	Offset-4 Start Freq	60 MHz
	Offset-1 Stop Freq	21 MHz
	Offset-2 Stop Freq	40 MHz
	Offset-3 Stop Freq	60 MHz
	Offset-4 Stop Freq	100 MHz
	Offset-1 Reference Level	Auto
	Offset-2 Reference Level	Auto
	Offset-3 Reference Level	Auto
	Offset-4 Reference Level	Auto
	Offset-1 RBW	100 kHz
	Offset-2 RBW	100 kHz
	Offset-3 RBW	100 kHz
	Offset-4 RBW	100 kHz
	Offset-1 Sweep Time	Auto
	Offset-2 Sweep Time	Auto
	Offset-3 Sweep Time	Auto
	Offset-4 Sweep Time	Auto
Offset-1 Auto Sweep Time Select	Fast	
Offset-2 Auto Sweep Time Select	Fast	
Offset-3 Auto Sweep Time Select	Fast	
Offset-4 Auto Sweep Time Select	Fast	

Table C-5 Standard parameters for Spectrum Emission Mask (Cont'd)

Standard	Parameter Name	Setting
SEM 802.11n BW_40MHz (2.4GHz) (WLAN) (IEEE 802.11-2012)	Offset-1 Detection	RMS
	Offset-2 Detection	RMS
	Offset-3 Detection	RMS
	Offset-4 Detection	RMS
	Offset-1 Trace Point	1001
	Offset-2 Trace Point	1001
	Offset-3 Trace Point	1001
	Offset-4 Trace Point	1001
	Offset-1 Integrate BW	Auto
	Offset-2 Integrate BW	Auto
	Offset-3 Integrate BW	Auto
	Offset-4 Integrate BW	Auto
	Offset-1 On/Off	On
	Offset-2 On/Off	On
	Offset-3 On/Off	On
	Offset-4 On/Off	On
	Limit-1 REL Start Level	0.0 dB
	Limit-2 REL Start Level	-20.0 dB
	Limit-3 REL Start Level	-28.0 dB
	Limit-4 REL Start Level	-45.0 dB
	Limit-1 REL Stop Level	-20.0 dB
	Limit-2 REL Stop Level	-28.0 dB
	Limit-3 REL Stop Level	-45.0 dB
	Limit-4 REL Stop Level	-45.0 dB
	Limit-1 Fail Logic	REL
	Limit-2 Fail Logic	REL
	Limit-3 Fail Logic	REL
	Limit-4 Fail Logic	REL

Table C-5 Standard parameters for Spectrum Emission Mask (Cont'd)

Standard	Parameter Name	Setting
SEM 802.11n BW_40MHz (5GHz) (WLAN) (IEEE 802.11-2012)	Limit Side	Both
	Noise Cancel	Off
	Reference Mode	Peak
	Channel BW	38 MHz
	RBW	100 kHz
	Sweep Time	Auto
	Auto Sweep Time Select	Fast
	Detection	RMS
	Trace Point	1001
	Filter Type	Rect
	Offset-1 Start Freq	19 MHz
	Offset-2 Start Freq	21 MHz
	Offset-3 Start Freq	40 MHz
	Offset-4 Start Freq	60 MHz
	Offset-1 Stop Freq	21 MHz
	Offset-2 Stop Freq	40 MHz
	Offset-3 Stop Freq	60 MHz
	Offset-4 Stop Freq	100 MHz
	Offset-1 Reference Level	Auto
	Offset-2 Reference Level	Auto
	Offset-3 Reference Level	Auto
	Offset-4 Reference Level	Auto
	Offset-1 RBW	100 kHz
	Offset-2 RBW	100 kHz
	Offset-3 RBW	100 kHz
	Offset-4 RBW	100 kHz
	Offset-1 Sweep Time	Auto
	Offset-2 Sweep Time	Auto
	Offset-3 Sweep Time	Auto
	Offset-4 Sweep Time	Auto
	Offset-1 Auto Sweep Time Select	Fast
	Offset-2 Auto Sweep Time Select	Fast
Offset-3 Auto Sweep Time Select	Fast	
Offset-4 Auto Sweep Time Select	Fast	

Table C-5 Standard parameters for Spectrum Emission Mask (Cont'd)

Standard	Parameter Name	Setting
SEM 802.11n BW_40MHz (5GHz) (WLAN) (IEEE 802.11-2012)	Offset-1 Detection	RMS
	Offset-2 Detection	RMS
	Offset-3 Detection	RMS
	Offset-4 Detection	RMS
	Offset-1 Trace Point	1001
	Offset-2 Trace Point	1001
	Offset-3 Trace Point	1001
	Offset-4 Trace Point	1001
	Offset-1 Integrate BW	Auto
	Offset-2 Integrate BW	Auto
	Offset-3 Integrate BW	Auto
	Offset-4 Integrate BW	Auto
	Offset-1 On/Off	On
	Offset-2 On/Off	On
	Offset-3 On/Off	On
	Offset-4 On/Off	On
	Limit-1 REL Start Level	0.0 dB
	Limit-2 REL Start Level	-20.0 dB
	Limit-3 REL Start Level	-28.0 dB
	Limit-4 REL Start Level	-40.0 dB
	Limit-1 REL Stop Level	-20.0 dB
	Limit-2 REL Stop Level	-28.0 dB
	Limit-3 REL Stop Level	-40.0 dB
	Limit-4 REL Stop Level	-40.0 dB
	Limit-1 Fail Logic	REL
	Limit-2 Fail Logic	REL
	Limit-3 Fail Logic	REL
	Limit-4 Fail Logic	REL

SEM 802.11ac

Table C-5 Standard parameters for Spectrum Emission Mask (Cont'd)

Standard	Parameter Name	Setting
SEM 802.11ac BW_20MHz (WLAN) (IEEE 802.11ac-2013)	Limit Side	Both
	Noise Cancel	Off
	Reference Mode	Peak
	Channel BW	18 MHz
	RBW	100 kHz
	Sweep Time	Auto
	Auto Sweep Time Select	Fast
	Detection	RMS
	Trace Point	1001
	Filter Type	Rect
	Offset-1 Start Freq	9 MHz
	Offset-2 Start Freq	11 MHz
	Offset-3 Start Freq	20 MHz
	Offset-4 Start Freq	30 MHz
	Offset-1 Stop Freq	11 MHz
	Offset-2 Stop Freq	20 MHz
	Offset-3 Stop Freq	30 MHz
	Offset-4 Stop Freq	50 MHz
	Offset-1 Reference Level	Auto
	Offset-2 Reference Level	Auto
	Offset-3 Reference Level	Auto
	Offset-4 Reference Level	Auto
	Offset-1 RBW	100 kHz
	Offset-2 RBW	100 kHz
	Offset-3 RBW	100 kHz
	Offset-4 RBW	100 kHz
	Offset-1 Sweep Time	Auto
	Offset-2 Sweep Time	Auto
	Offset-3 Sweep Time	Auto
	Offset-4 Sweep Time	Auto
	Offset-1 Auto Sweep Time Select	Fast
	Offset-2 Auto Sweep Time Select	Fast
Offset-3 Auto Sweep Time Select	Fast	
Offset-4 Auto Sweep Time Select	Fast	

Table C-5 Standard parameters for Spectrum Emission Mask (Cont'd)

Standard	Parameter Name	Setting
SEM 802.11ac BW_20MHz (WLAN) (IEEE 802.11ac-2013)	Offset-1 Detection	RMS
	Offset-2 Detection	RMS
	Offset-3 Detection	RMS
	Offset-4 Detection	RMS
	Offset-1 Trace Point	1001
	Offset-2 Trace Point	1001
	Offset-3 Trace Point	1001
	Offset-4 Trace Point	1001
	Offset-1 Integrate BW	Auto
	Offset-2 Integrate BW	Auto
	Offset-3 Integrate BW	Auto
	Offset-4 Integrate BW	Auto
	Offset-1 On/Off	On
	Offset-2 On/Off	On
	Offset-3 On/Off	On
	Offset-4 On/Off	On
	Limit-1 REL Start Level	0.0 dB
	Limit-2 REL Start Level	-20.0 dB
	Limit-3 REL Start Level	-28.0 dB
	Limit-4 REL Start Level	-40.0 dB
	Limit-1 REL Stop Level	-20.0 dB
	Limit-2 REL Stop Level	-28.0 dB
	Limit-3 REL Stop Level	-40.0 dB
	Limit-4 REL Stop Level	-40.0 dB
	Limit-1 Fail Logic	REL
	Limit-2 Fail Logic	REL
	Limit-3 Fail Logic	REL
	Limit-4 Fail Logic	REL

Table C-5 Standard parameters for Spectrum Emission Mask (Cont'd)

Standard	Parameter Name	Setting
SEM 802.11ac BW_40MHz (WLAN) (IEEE 802.11ac-2013)	Limit Side	Both
	Noise Cancel	Off
	Reference Mode	Peak
	Channel BW	38 MHz
	RBW	100 kHz
	Sweep Time	Auto
	Auto Sweep Time Select	Fast
	Detection	RMS
	Trace Point	1001
	Filter Type	Rect
	Offset-1 Start Freq	19 MHz
	Offset-2 Start Freq	21 MHz
	Offset-3 Start Freq	40 MHz
	Offset-4 Start Freq	60 MHz
	Offset-5 Start Freq	60 MHz
	Offset-1 Stop Freq	21 MHz
	Offset-2 Stop Freq	40 MHz
	Offset-3 Stop Freq	60 MHz
	Offset-4 Stop Freq	100 MHz
	Offset-1 Reference Level	Auto
	Offset-2 Reference Level	Auto
	Offset-3 Reference Level	Auto
	Offset-4 Reference Level	Auto
	Offset-1 RBW	100 kHz
	Offset-2 RBW	100 kHz
	Offset-3 RBW	100 kHz
	Offset-4 RBW	100 kHz
	Offset-1 Sweep Time	Auto
	Offset-2 Sweep Time	Auto
	Offset-3 Sweep Time	Auto
	Offset-4 Sweep Time	Auto
	Offset-1 Auto Sweep Time Select	Fast
Offset-2 Auto Sweep Time Select	Fast	
Offset-3 Auto Sweep Time Select	Fast	
Offset-4 Auto Sweep Time Select	Fast	

Table C-5 Standard parameters for Spectrum Emission Mask (Cont'd)

Standard	Parameter Name	Setting
SEM 802.11ac BW_40MHz (WLAN) (IEEE 802.11ac-2013)	Offset-1 Detection	RMS
	Offset-2 Detection	RMS
	Offset-3 Detection	RMS
	Offset-4 Detection	RMS
	Offset-1 Trace Point	1001
	Offset-2 Trace Point	1001
	Offset-3 Trace Point	1001
	Offset-4 Trace Point	1001
	Offset-1 Integrate BW	Auto
	Offset-2 Integrate BW	Auto
	Offset-3 Integrate BW	Auto
	Offset-4 Integrate BW	Auto
	Offset-1 On/Off	On
	Offset-2 On/Off	On
	Offset-3 On/Off	On
	Offset-4 On/Off	On
	Limit-1 REL Start Level	0.0 dB
	Limit-2 REL Start Level	-20.0 dB
	Limit-3 REL Start Level	-28.0 dB
	Limit-4 REL Start Level	-40.0 dB
	Limit-1 REL Stop Level	-20.0 dB
	Limit-2 REL Stop Level	-28.0 dB
	Limit-3 REL Stop Level	-40.0 dB
	Limit-4 REL Stop Level	-40.0 dB
	Limit-1 Fail Logic	REL
	Limit-2 Fail Logic	REL
	Limit-3 Fail Logic	REL
	Limit-4 Fail Logic	REL

Table C-5 Standard parameters for Spectrum Emission Mask (Cont'd)

Standard	Parameter Name	Setting
SEM 802.11ac BW_80MHz (WLAN) (IEEE 802.11ac-2013)	Limit Side	Both
	Noise Cancel	Off
	Reference Mode	Peak
	Channel BW	78 MHz
	RBW	100 kHz
	Sweep Time	Auto
	Auto Sweep Time Select	Fast
	Detection	RMS
	Trace Point	1001
	Filter Type	Rect
	Offset-1 Start Freq	39 MHz
	Offset-2 Start Freq	41 MHz
	Offset-3 Start Freq	80 MHz
	Offset-4 Start Freq	120 MHz
	Offset-1 Stop Freq	41 MHz
	Offset-2 Stop Freq	80 MHz
	Offset-3 Stop Freq	120 MHz
	Offset-4 Stop Freq	200 MHz
	Offset-1 Reference Level	Auto
	Offset-2 Reference Level	Auto
	Offset-3 Reference Level	Auto
	Offset-4 Reference Level	Auto
	Offset-1 RBW	100 kHz
	Offset-2 RBW	100 kHz
	Offset-3 RBW	100 kHz
	Offset-4 RBW	100 kHz
	Offset-1 Sweep Time	Auto
	Offset-2 Sweep Time	Auto
	Offset-3 Sweep Time	Auto
	Offset-4 Sweep Time	Auto
	Offset-1 Auto Sweep Time Select	Fast
	Offset-2 Auto Sweep Time Select	Fast
Offset-3 Auto Sweep Time Select	Fast	
Offset-4 Auto Sweep Time Select	Fast	

Table C-5 Standard parameters for Spectrum Emission Mask (Cont'd)

Standard	Parameter Name	Setting
SEM 802.11ac BW_80MHz (WLAN) (IEEE 802.11ac-2013)	Offset-1 Detection	RMS
	Offset-2 Detection	RMS
	Offset-3 Detection	RMS
	Offset-4 Detection	RMS
	Offset-1 Trace Point	1001
	Offset-2 Trace Point	1001
	Offset-3 Trace Point	1001
	Offset-4 Trace Point	1001
	Offset-1 Integrate BW	Auto
	Offset-2 Integrate BW	Auto
	Offset-3 Integrate BW	Auto
	Offset-4 Integrate BW	Auto
	Offset-1 On/Off	On
	Offset-2 On/Off	On
	Offset-3 On/Off	On
	Offset-4 On/Off	On
	Limit-1 REL Start Level	0.0 dB
	Limit-2 REL Start Level	-20.0 dB
	Limit-3 REL Start Level	-28.0 dB
	Limit-4 REL Start Level	-40.0 dB
	Limit-1 REL Stop Level	-20.0 dB
	Limit-2 REL Stop Level	-28.0 dB
	Limit-3 REL Stop Level	-40.0 dB
	Limit-4 REL Stop Level	-40.0 dB
	Limit-1 Fail Logic	REL
	Limit-2 Fail Logic	REL
	Limit-3 Fail Logic	REL
	Limit-4 Fail Logic	REL

Table C-5 Standard parameters for Spectrum Emission Mask (Cont'd)

Standard	Parameter Name	Setting
SEM 802.11ac BW_160MHz (WLAN) (IEEE 802.11ac-2013)	Limit Side	Both
	Noise Cancel	Off
	Reference Mode	Peak
	Channel BW	158 MHz
	RBW	100 kHz
	Sweep Time	Auto
	Auto Sweep Time Select	Fast
	Detection	RMS
	Trace Point	1001
	Filter Type	Rect
	Offset-1 Start Freq	79 MHz
	Offset-2 Start Freq	81 MHz
	Offset-3 Start Freq	160 MHz
	Offset-4 Start Freq	240 MHz
	Offset-1 Stop Freq	81 MHz
	Offset-2 Stop Freq	160 MHz
	Offset-3 Stop Freq	240 MHz
	Offset-4 Stop Freq	400 MHz
	Offset-1 Reference Level	Auto
	Offset-2 Reference Level	Auto
	Offset-3 Reference Level	Auto
	Offset-4 Reference Level	Auto
	Offset-1 RBW	100 kHz
	Offset-2 RBW	100 kHz
	Offset-3 RBW	100 kHz
	Offset-4 RBW	100 kHz
	Offset-1 Sweep Time	Auto
	Offset-2 Sweep Time	Auto
	Offset-3 Sweep Time	Auto
	Offset-4 Sweep Time	Auto
	Offset-1 Auto Sweep Time Select	Fast
	Offset-2 Auto Sweep Time Select	Fast
Offset-3 Auto Sweep Time Select	Fast	
Offset-4 Auto Sweep Time Select	Fast	

Table C-5 Standard parameters for Spectrum Emission Mask (Cont'd)

Standard	Parameter Name	Setting
SEM 802.11ac BW_160MHz (WLAN) (IEEE 802.11ac-2013)	Offset-1 Detection	RMS
	Offset-2 Detection	RMS
	Offset-3 Detection	RMS
	Offset-4 Detection	RMS
	Offset-1 Trace Point	1001
	Offset-2 Trace Point	1001
	Offset-3 Trace Point	1001
	Offset-4 Trace Point	1001
	Offset-1 Integrate BW	Auto
	Offset-2 Integrate BW	Auto
	Offset-3 Integrate BW	Auto
	Offset-4 Integrate BW	Auto
	Offset-1 On/Off	On
	Offset-2 On/Off	On
	Offset-3 On/Off	On
	Offset-4 On/Off	On
	Limit-1 REL Start Level	0.0 dB
	Limit-2 REL Start Level	-20.0 dB
	Limit-3 REL Start Level	-28.0 dB
	Limit-4 REL Start Level	-40.0 dB
	Limit-1 REL Stop Level	-20.0 dB
	Limit-2 REL Stop Level	-28.0 dB
	Limit-3 REL Stop Level	-40.0 dB
	Limit-4 REL Stop Level	-40.0 dB
	Limit-1 Fail Logic	REL
	Limit-2 Fail Logic	REL
	Limit-3 Fail Logic	REL
	Limit-4 Fail Logic	REL

ETSI EN 301 893

Table C-5 Standard parameters for Spectrum Emission Mask (Cont'd)

Standard	Parameter Name	Setting
ETSI EN 301 893 V1.5.1 OFDM 5MHz (WLAN)	Limit Side	Both
	Noise Cancel	Off
	Reference Mode	Peak
	Channel BW	5 MHz
	RBW	1 MHz
	VBW	30 kHz
	Sweep Time	Auto
	Auto Sweep Time Select	Fast
	Detection	RMS
	Trace Point	1001
	Filter Type	Rect
	Offset-1 Start Freq	2.375 MHz
	Offset-2 Start Freq	2.750 MHz
	Offset-3 Start Freq	5.0 MHz
	Offset-4 Start Freq	7.5 MHz
	Offset-5 Start Freq	45 MHz
	Offset-6 Start Freq	54 MHz
	Offset-1 Stop Freq	2.750 MHz
	Offset-2 Stop Freq	5.0 MHz
	Offset-3 Stop Freq	7.5 MHz
	Offset-4 Stop Freq	45 MHz
	Offset-5 Stop Freq	54 MHz
	Offset-6 Stop Freq	60 MHz
	Offset-1 Reference Level	Auto
	Offset-2 Reference Level	Auto
	Offset-3 Reference Level	Auto
	Offset-4 Reference Level	Auto
	Offset-5 Reference Level	Auto
	Offset-6 Reference Level	Auto
	Offset-1 RBW	1 MHz
Offset-2 RBW	1 MHz	
Offset-3 RBW	1 MHz	
Offset-4 RBW	1 MHz	
Offset-5 RBW	1 MHz	
Offset-6 RBW	1 MHz	

Table C-5 Standard parameters for Spectrum Emission Mask (Cont'd)

Standard	Parameter Name	Setting
ETSI EN 301 893 V1.5.1 OFDM 5MHz (WLAN)	Offset-1 VBW	30 kHz
	Offset-2 VBW	30 kHz
	Offset-3 VBW	30 kHz
	Offset-4 VBW	30 kHz
	Offset-5 VBW	30 kHz
	Offset-6 VBW	30 kHz
	Offset-1 Sweep Time	Auto
	Offset-2 Sweep Time	Auto
	Offset-3 Sweep Time	Auto
	Offset-4 Sweep Time	Auto
	Offset-5 Sweep Time	Auto
	Offset-6 Sweep Time	Auto
	Offset-1 Auto Sweep Time Select	Fast
	Offset-2 Auto Sweep Time Select	Fast
	Offset-3 Auto Sweep Time Select	Fast
	Offset-4 Auto Sweep Time Select	Fast
	Offset-5 Auto Sweep Time Select	Fast
	Offset-6 Auto Sweep Time Select	Fast
	Offset-1 Detection	RMS
	Offset-2 Detection	RMS
	Offset-3 Detection	RMS
	Offset-4 Detection	RMS
	Offset-5 Detection	RMS
	Offset-6 Detection	RMS
	Offset-1 Trace Point	1001
	Offset-2 Trace Point	1001
	Offset-3 Trace Point	1001
	Offset-4 Trace Point	1001
Offset-5 Trace Point	1001	
Offset-6 Trace Point	1001	

Table C-5 Standard parameters for Spectrum Emission Mask (Cont'd)

Standard	Parameter Name	Setting
ETSI EN 301 893 V1.5.1 OFDM 5MHz (WLAN)	Offset-1 Integrate BW	Auto
	Offset-2 Integrate BW	Auto
	Offset-3 Integrate BW	Auto
	Offset-4 Integrate BW	Auto
	Offset-5 Integrate BW	Auto
	Offset-6 Integrate BW	Auto
	Offset-1 On/Off	On
	Offset-2 On/Off	On
	Offset-3 On/Off	On
	Offset-4 On/Off	On
	Offset-5 On/Off	On
	Offset-6 On/Off	On
	Limit-1 REL Start Level	0.0 dB
	Limit-2 REL Start Level	-20.0 dB
	Limit-3 REL Start Level	-28.0 dB
	Limit-4 REL Start Level	-40.0 dB
	Limit-5 REL Start Level	-42.0 dB
	Limit-6 REL Start Level	-47.0 dB
	Limit-1 REL Stop Level	-20.0 dB
	Limit-2 REL Stop Level	-28.0 dB
	Limit-3 REL Stop Level	-40.0 dB
	Limit-4 REL Stop Level	-40.0 dB
	Limit-5 REL Stop Level	-42.0 dB
	Limit-6 REL Stop Level	-47.0 dB
	Limit-1 Fail Logic	REL
	Limit-2 Fail Logic	REL
	Limit-3 Fail Logic	REL
	Limit-4 Fail Logic	REL
Limit-5 Fail Logic	REL	
Limit-6 Fail Logic	REL	

Table C-5 Standard parameters for Spectrum Emission Mask (Cont'd)

Standard	Parameter Name	Setting
ETSI EN 301 893 V1.5.1 OFDM 10MHz (WLAN)	Limit Side	Both
	Noise Cancel	Off
	Reference Mode	Peak
	Channel BW	10 MHz
	RBW	1 MHz
	VBW	30 kHz
	Sweep Time	Auto
	Auto Sweep Time Select	Fast
	Detection	RMS
	Trace Point	1001
	Filter Type	Rect
	Offset-1 Start Freq	4.75 MHz
	Offset-2 Start Freq	5.5 MHz
	Offset-3 Start Freq	10.0 MHz
	Offset-4 Start Freq	15.0 MHz
	Offset-5 Start Freq	90 MHz
	Offset-6 Start Freq	108 MHz
	Offset-1 Stop Freq	5.5 MHz
	Offset-2 Stop Freq	10.0 MHz
	Offset-3 Stop Freq	15.0 MHz
	Offset-4 Stop Freq	90 MHz
	Offset-5 Stop Freq	108 MHz
	Offset-6 Stop Freq	120 MHz
	Offset-1 Reference Level	Auto
	Offset-2 Reference Level	Auto
	Offset-3 Reference Level	Auto
	Offset-4 Reference Level	Auto
	Offset-5 Reference Level	Auto
	Offset-6 Reference Level	Auto
	Offset-1 RBW	1 MHz
Offset-2 RBW	1 MHz	
Offset-3 RBW	1 MHz	
Offset-4 RBW	1 MHz	
Offset-5 RBW	1 MHz	
Offset-6 RBW	1 MHz	

Table C-5 Standard parameters for Spectrum Emission Mask (Cont'd)

Standard	Parameter Name	Setting
ETSI EN 301 893 V1.5.1 OFDM 10MHz (WLAN)	Offset-1 VBW	30 kHz
	Offset-2 VBW	30 kHz
	Offset-3 VBW	30 kHz
	Offset-4 VBW	30 kHz
	Offset-5 VBW	30 kHz
	Offset-6 VBW	30 kHz
	Offset-1 Sweep Time	Auto
	Offset-2 Sweep Time	Auto
	Offset-3 Sweep Time	Auto
	Offset-4 Sweep Time	Auto
	Offset-5 Sweep Time	Auto
	Offset-6 Sweep Time	Auto
	Offset-1 Auto Sweep Time Select	Fast
	Offset-2 Auto Sweep Time Select	Fast
	Offset-3 Auto Sweep Time Select	Fast
	Offset-4 Auto Sweep Time Select	Fast
	Offset-5 Auto Sweep Time Select	Fast
	Offset-6 Auto Sweep Time Select	Fast
	Offset-1 Detection	RMS
	Offset-2 Detection	RMS
	Offset-3 Detection	RMS
	Offset-4 Detection	RMS
	Offset-5 Detection	RMS
	Offset-6 Detection	RMS
	Offset-1 Trace Point	1001
	Offset-2 Trace Point	1001
	Offset-3 Trace Point	1001
	Offset-4 Trace Point	1001
Offset-5 Trace Point	1001	
Offset-6 Trace Point	1001	

Table C-5 Standard parameters for Spectrum Emission Mask (Cont'd)

Standard	Parameter Name	Setting
ETSI EN 301 893 V1.5.1 OFDM 10MHz (WLAN)	Offset-1 Integrate BW	Auto
	Offset-2 Integrate BW	Auto
	Offset-3 Integrate BW	Auto
	Offset-4 Integrate BW	Auto
	Offset-5 Integrate BW	Auto
	Offset-6 Integrate BW	Auto
	Offset-1 On/Off	On
	Offset-2 On/Off	On
	Offset-3 On/Off	On
	Offset-4 On/Off	On
	Offset-5 On/Off	On
	Offset-6 On/Off	On
	Limit-1 REL Start Level	0.0 dB
	Limit-2 REL Start Level	-20.0 dB
	Limit-3 REL Start Level	-28.0 dB
	Limit-4 REL Start Level	-40.0 dB
	Limit-5 REL Start Level	-42.0 dB
	Limit-6 REL Start Level	-47.0 dB
	Limit-1 REL Stop Level	-20.0 dB
	Limit-2 REL Stop Level	-28.0 dB
	Limit-3 REL Stop Level	-40.0 dB
	Limit-4 REL Stop Level	-40.0 dB
	Limit-5 REL Stop Level	-42.0 dB
	Limit-6 REL Stop Level	-47.0 dB
	Limit-1 Fail Logic	REL
	Limit-2 Fail Logic	REL
	Limit-3 Fail Logic	REL
	Limit-4 Fail Logic	REL
Limit-5 Fail Logic	REL	
Limit-6 Fail Logic	REL	

Table C-5 Standard parameters for Spectrum Emission Mask (Cont'd)

Standard	Parameter Name	Setting
ETSI EN 301 893 V1.5.1 OFDM 20MHz (WLAN)	Limit Side	Both
	Noise Cancel	Off
	Reference Mode	Peak
	Channel BW	20 MHz
	RBW	1 MHz
	VBW	30 kHz
	Sweep Time	Auto
	Auto Sweep Time Select	Fast
	Detection	RMS
	Trace Point	1001
	Filter Type	Rect
	Offset-1 Start Freq	9.5 MHz
	Offset-2 Start Freq	11.0 MHz
	Offset-3 Start Freq	20.0 MHz
	Offset-4 Start Freq	30.0 MHz
	Offset-5 Start Freq	180 MHz
	Offset-6 Start Freq	216 MHz
	Offset-1 Stop Freq	11.0 MHz
	Offset-2 Stop Freq	20.0 MHz
	Offset-3 Stop Freq	30.0 MHz
	Offset-4 Stop Freq	180 MHz
	Offset-5 Stop Freq	216 MHz
	Offset-6 Stop Freq	240 MHz
	Offset-1 Reference Level	Auto
	Offset-2 Reference Level	Auto
	Offset-3 Reference Level	Auto
	Offset-4 Reference Level	Auto
	Offset-5 Reference Level	Auto
	Offset-6 Reference Level	Auto
	Offset-1 RBW	1 MHz
Offset-2 RBW	1 MHz	
Offset-3 RBW	1 MHz	
Offset-4 RBW	1 MHz	
Offset-5 RBW	1 MHz	
Offset-6 RBW	1 MHz	

Table C-5 Standard parameters for Spectrum Emission Mask (Cont'd)

Standard	Parameter Name	Setting
ETSI EN 301 893 V1.5.1 OFDM 20MHz (WLAN)	Offset-1 VBW	30 kHz
	Offset-2 VBW	30 kHz
	Offset-3 VBW	30 kHz
	Offset-4 VBW	30 kHz
	Offset-5 VBW	30 kHz
	Offset-6 VBW	30 kHz
	Offset-1 Sweep Time	Auto
	Offset-2 Sweep Time	Auto
	Offset-3 Sweep Time	Auto
	Offset-4 Sweep Time	Auto
	Offset-5 Sweep Time	Auto
	Offset-6 Sweep Time	Auto
	Offset-1 Auto Sweep Time Select	Fast
	Offset-2 Auto Sweep Time Select	Fast
	Offset-3 Auto Sweep Time Select	Fast
	Offset-4 Auto Sweep Time Select	Fast
	Offset-5 Auto Sweep Time Select	Fast
	Offset-6 Auto Sweep Time Select	Fast
	Offset-1 Detection	RMS
	Offset-2 Detection	RMS
	Offset-3 Detection	RMS
	Offset-4 Detection	RMS
	Offset-5 Detection	RMS
	Offset-6 Detection	RMS
	Offset-1 Trace Point	1001
	Offset-2 Trace Point	1001
	Offset-3 Trace Point	1001
	Offset-4 Trace Point	1001
Offset-5 Trace Point	1001	
Offset-6 Trace Point	1001	

Appendix

Appendix C

Table C-5 Standard parameters for Spectrum Emission Mask (Cont'd)

Standard	Parameter Name	Setting
ETSI EN 301 893 V1.5.1 OFDM 20MHz (WLAN)	Offset-1 Integrate BW	Auto
	Offset-2 Integrate BW	Auto
	Offset-3 Integrate BW	Auto
	Offset-4 Integrate BW	Auto
	Offset-5 Integrate BW	Auto
	Offset-6 Integrate BW	Auto
	Offset-1 On/Off	On
	Offset-2 On/Off	On
	Offset-3 On/Off	On
	Offset-4 On/Off	On
	Offset-5 On/Off	On
	Offset-6 On/Off	On
	Limit-1 REL Start Level	0.0 dB
	Limit-2 REL Start Level	-20.0 dB
	Limit-3 REL Start Level	-28.0 dB
	Limit-4 REL Start Level	-40.0 dB
	Limit-5 REL Start Level	-42.0 dB
	Limit-6 REL Start Level	-47.0 dB
	Limit-1 REL Stop Level	-20.0 dB
	Limit-2 REL Stop Level	-28.0 dB
	Limit-3 REL Stop Level	-40.0 dB
	Limit-4 REL Stop Level	-40.0 dB
	Limit-5 REL Stop Level	-42.0 dB
	Limit-6 REL Stop Level	-47.0 dB
	Limit-1 Fail Logic	REL
	Limit-2 Fail Logic	REL
	Limit-3 Fail Logic	REL
	Limit-4 Fail Logic	REL
Limit-5 Fail Logic	REL	
Limit-6 Fail Logic	REL	

Table C-5 Standard parameters for Spectrum Emission Mask (Cont'd)

Standard	Parameter Name	Setting
ETSI EN 301 893 V1.5.1 OFDM 40MHz (WLAN)	Limit Side	Both
	Noise Cancel	Off
	Reference Mode	Peak
	Channel BW	20 MHz
	RBW	1 MHz
	VBW	30 kHz
	Sweep Time	Auto
	Auto Sweep Time Select	Fast
	Detection	RMS
	Trace Point	1001
	Filter Type	Rect
	Offset-1 Start Freq	19.0 MHz
	Offset-2 Start Freq	22.0 MHz
	Offset-3 Start Freq	40.0 MHz
	Offset-4 Start Freq	60.0 MHz
	Offset-5 Start Freq	360 MHz
	Offset-6 Start Freq	432 MHz
	Offset-1 Stop Freq	22.0 MHz
	Offset-2 Stop Freq	40.0 MHz
	Offset-3 Stop Freq	60.0 MHz
	Offset-4 Stop Freq	360 MHz
	Offset-5 Stop Freq	432 MHz
	Offset-6 Stop Freq	480 MHz
	Offset-1 Reference Level	Auto
	Offset-2 Reference Level	Auto
	Offset-3 Reference Level	Auto
	Offset-4 Reference Level	Auto
	Offset-5 Reference Level	Auto
	Offset-6 Reference Level	Auto
	Offset-1 RBW	1 MHz
Offset-2 RBW	1 MHz	
Offset-3 RBW	1 MHz	
Offset-4 RBW	1 MHz	
Offset-5 RBW	1 MHz	
Offset-6 RBW	1 MHz	

Table C-5 Standard parameters for Spectrum Emission Mask (Cont'd)

Standard	Parameter Name	Setting
ETSI EN 301 893 V1.5.1 OFDM 40MHz (WLAN)	Offset-1 VBW	30 kHz
	Offset-2 VBW	30 kHz
	Offset-3 VBW	30 kHz
	Offset-4 VBW	30 kHz
	Offset-5 VBW	30 kHz
	Offset-6 VBW	30 kHz
	Offset-1 Sweep Time	Auto
	Offset-2 Sweep Time	Auto
	Offset-3 Sweep Time	Auto
	Offset-4 Sweep Time	Auto
	Offset-5 Sweep Time	Auto
	Offset-6 Sweep Time	Auto
	Offset-1 Auto Sweep Time Select	Fast
	Offset-2 Auto Sweep Time Select	Fast
	Offset-3 Auto Sweep Time Select	Fast
	Offset-4 Auto Sweep Time Select	Fast
	Offset-5 Auto Sweep Time Select	Fast
	Offset-6 Auto Sweep Time Select	Fast
	Offset-1 Detection	RMS
	Offset-2 Detection	RMS
	Offset-3 Detection	RMS
	Offset-4 Detection	RMS
	Offset-5 Detection	RMS
	Offset-6 Detection	RMS
	Offset-1 Trace Point	1001
	Offset-2 Trace Point	1001
	Offset-3 Trace Point	1001
	Offset-4 Trace Point	1001
Offset-5 Trace Point	1001	
Offset-6 Trace Point	1001	

Table C-5 Standard parameters for Spectrum Emission Mask (Cont'd)

Standard	Parameter Name	Setting
ETSI EN 301 893 V1.5.1 OFDM 40MHz (WLAN)	Offset-1 Integrate BW	Auto
	Offset-2 Integrate BW	Auto
	Offset-3 Integrate BW	Auto
	Offset-4 Integrate BW	Auto
	Offset-5 Integrate BW	Auto
	Offset-6 Integrate BW	Auto
	Offset-1 On/Off	On
	Offset-2 On/Off	On
	Offset-3 On/Off	On
	Offset-4 On/Off	On
	Offset-5 On/Off	On
	Offset-6 On/Off	On
	Limit-1 REL Start Level	0.0 dB
	Limit-2 REL Start Level	-20.0 dB
	Limit-3 REL Start Level	-28.0 dB
	Limit-4 REL Start Level	-40.0 dB
	Limit-5 REL Start Level	-42.0 dB
	Limit-6 REL Start Level	-47.0 dB
	Limit-1 REL Stop Level	-20.0 dB
	Limit-2 REL Stop Level	-28.0 dB
	Limit-3 REL Stop Level	-40.0 dB
	Limit-4 REL Stop Level	-40.0 dB
	Limit-5 REL Stop Level	-42.0 dB
	Limit-6 REL Stop Level	-47.0 dB
	Limit-1 Fail Logic	REL
	Limit-2 Fail Logic	REL
	Limit-3 Fail Logic	REL
	Limit-4 Fail Logic	REL
Limit-5 Fail Logic	REL	
Limit-6 Fail Logic	REL	

O-QPSK

Table C-5 Standard parameters for Spectrum Emission Mask (Cont'd)

Standard	Parameter Name	Setting
O-QPSK 2450MHz (LR-WPANs)	Limit Side	Both
	Noise Cancel	Off
	Reference Mode	Peak
	Channel BW	2 MHz
	RBW	100 kHz
	Sweep Time	Auto
	Auto Sweep Time Select	Normal
	Detection	RMS
	Trace Point	1001
	Filter Type	Rect
	Offset-1 Start Freq	3.5 MHz
	Offset-1 Stop Freq	5.0 MHz
	Offset-1 Reference Level	Auto
	Offset-1 RBW	100 kHz
	Offset-1 Sweep Time	Auto
	Offset-1 Auto Sweep Time Select	Normal
	Offset-1 Detection	RMS
	Offset-1 Trace Point	1001
	Offset-1 Integrate BW	Auto
	Limit-1 REL Start Level	-20.0 dB
	Limit-1 REL Stop Level	-20.0 dB
Limit-1 Fail Logic	ABS1 and REL	
Limit-1 ABS1 Start Level	-30.0 dBm	
Limit-1 ABS1 Stop Level	-30.0 dBm	

BPSK

Table C-5 Standard parameters for Spectrum Emission Mask (Cont'd)

Standard	Parameter Name	Setting
BPSK 950MHz (LR-WPANs)	Limit Side	Both
	Noise Cancel	Off
	Reference Mode	Peak
	Channel BW	2 MHz
	RBW	100 kHz
	Sweep Time	Auto
	Auto Sweep Time Select	Normal
	Detection	RMS
	Trace Point	1001
	Filter Type	Rect
	Offset-1 Start Freq	400 kHz
	Offset-1 Stop Freq	1.0 MHz
	Offset-1 Reference Level	Auto
	Offset-1 RBW	100 kHz
	Offset-1 Sweep Time	Auto
	Offset-1 Auto Sweep Time Select	Normal
	Offset-1 Detection	RMS
	Offset-1 Trace Point	1001
	Offset-1 Integrate BW	Auto
	Limit-1 Fail Logic	REL
Limit-1 ABS1 Start Level	-39.0 dBm	
Limit-1 ABS1 Stop Level	-39.0 dBm	

GFSK

Table C-5 Standard parameters for Spectrum Emission Mask (Cont'd)

Standard	Parameter Name	Setting
GFSK 50ksps 950MHz (LR-WPANs)	Limit Side	Both
	Noise Cancel	Off
	Reference Mode	Peak
	Channel BW	2 MHz
	RBW	100 kHz
	Sweep Time	Auto
	Auto Sweep Time Select	Normal
	Detection	RMS
	Trace Point	1001
	Filter Type	Rect
	Offset-1 Start Freq	200 kHz
	Offset-1 Stop Freq	1.0 MHz
	Offset-1 Reference Level	Auto
	Offset-1 RBW	100 kHz
	Offset-1 Sweep Time	Auto
	Offset-1 Auto Sweep Time Select	Normal
	Offset-1 Detection	RMS
	Offset-1 Trace Point	1001
	Offset-1 Integrate BW	Auto
	Limit-1 Fail Logic	REL
Limit-1 ABS1 Start Level	-39.0 dBm	
Limit-1 ABS1 Stop Level	-39.0 dBm	

Table C-5 Standard parameters for Spectrum Emission Mask (Cont'd)

Standard	Parameter Name	Setting
GFSK 100ksps 950MHz (LR-WPANs)	Limit Side	Both
	Noise Cancel	Off
	Reference Mode	Peak
	Channel BW	2 MHz
	RBW	100 kHz
	Sweep Time	Auto
	Auto Sweep Time Select	Normal
	Detection	RMS
	Trace Point	1001
	Filter Type	Rect
	Offset-1 Start Freq	300 kHz
	Offset-1 Stop Freq	1.0 MHz
	Offset-1 Reference Level	Auto
	Offset-1 RBW	100 kHz
	Offset-1 Sweep Time	Auto
	Offset-1 Auto Sweep Time Select	Normal
	Offset-1 Detection	RMS
	Offset-1 Trace Point	1001
	Offset-1 Integrate BW	Auto
	Limit-1 Fail Logic	REL
Limit-1 ABS1 Start Level	-39.0 dBm	
Limit-1 ABS1 Stop Level	-39.0 dBm	

Table C-5 Standard parameters for Spectrum Emission Mask (Cont'd)

Standard	Parameter Name	Setting
GFSK 200ksps 950MHz (LR-WPANs)	Limit Side	Both
	Noise Cancel	Off
	Reference Mode	Peak
	Channel BW	2 MHz
	RBW	100 kHz
	Sweep Time	Auto
	Auto Sweep Time Select	Normal
	Detection	RMS
	Trace Point	1001
	Filter Type	Rect
	Offset-1 Start Freq	500 kHz
	Offset-1 Stop Freq	1.0 MHz
	Offset-1 Reference Level	Auto
	Offset-1 RBW	100 kHz
	Offset-1 Sweep Time	Auto
	Offset-1 Auto Sweep Time Select	Normal
	Offset-1 Detection	RMS
	Offset-1 Trace Point	1001
	Offset-1 Integrate BW	Auto
	Limit-1 Fail Logic	REL
Limit-1 ABS1 Start Level	-39.0 dBm	
Limit-1 ABS1 Stop Level	-39.0 dBm	

Table C-5 Standard parameters for Spectrum Emission Mask (Cont'd)

Standard	Parameter Name	Setting
GFSK 50ksps 920MHz (LR-WPANs)	Limit Side	Both
	Noise Cancel	Off
	Reference Mode	Peak
	Channel BW	2 MHz
	RBW	100 kHz
	Sweep Time	Auto
	Auto Sweep Time Select	Normal
	Detection	RMS
	Trace Point	1001
	Filter Type	Rect
	Offset-1 Start Freq	300 kHz
	Offset-1 Stop Freq	1.0 MHz
	Offset-1 Reference Level	Auto
	Offset-1 RBW	100 kHz
	Offset-1 Sweep Time	Auto
	Offset-1 Auto Sweep Time Select	Normal
	Offset-1 Detection	RMS
	Offset-1 Trace Point	1001
	Offset-1 Integrate BW	Auto
	Limit-1 Fail Logic	REL
Limit-1 ABS1 Start Level	-29.0 dBm	
Limit-1 ABS1 Stop Level	-29.0 dBm	

Table C-5 Standard parameters for Spectrum Emission Mask (Cont'd)

Standard	Parameter Name	Setting
GFSK 100ksps 920MHz (LR-WPANs)	Limit Side	Both
	Noise Cancel	Off
	Reference Mode	Peak
	Channel BW	2 MHz
	RBW	100 kHz
	Sweep Time	Auto
	Auto Sweep Time Select	Normal
	Detection	RMS
	Trace Point	1001
	Filter Type	Rect
	Offset-1 Start Freq	400 kHz
	Offset-1 Stop Freq	1.0 MHz
	Offset-1 Reference Level	Auto
	Offset-1 RBW	100 kHz
	Offset-1 Sweep Time	Auto
	Offset-1 Auto Sweep Time Select	Normal
	Offset-1 Detection	RMS
	Offset-1 Trace Point	1001
	Offset-1 Integrate BW	Auto
	Limit-1 Fail Logic	REL
Limit-1 ABS1 Start Level	-29.0 dBm	
Limit-1 ABS1 Stop Level	-29.0 dBm	

Table C-5 Standard parameters for Spectrum Emission Mask (Cont'd)

Standard	Parameter Name	Setting
GFSK 200ksps 920MHz (LR-WPANs)	Limit Side	Both
	Noise Cancel	Off
	Reference Mode	Peak
	Channel BW	2 MHz
	RBW	100 kHz
	Sweep Time	Auto
	Auto Sweep Time Select	Normal
	Detection	RMS
	Trace Point	1001
	Filter Type	Rect
	Offset-1 Start Freq	600 kHz
	Offset-1 Stop Freq	1.0 MHz
	Offset-1 Reference Level	Auto
	Offset-1 RBW	100 kHz
	Offset-1 Sweep Time	Auto
	Offset-1 Auto Sweep Time Select	Normal
	Offset-1 Detection	RMS
	Offset-1 Trace Point	1001
	Offset-1 Integrate BW	Auto
	Limit-1 Fail Logic	REL
Limit-1 ABS1 Start Level	-29.0 dBm	
Limit-1 ABS1 Stop Level	-29.0 dBm	

APCO P25

Table C-5 Standard parameters for Spectrum Emission Mask (Cont'd)

Standard	Parameter Name	Setting
APCO P25 FCC 12.5kHz	Limit Side	Both
	Noise Cancel	Off
	Reference Mode	Peak
	Channel BW	11.25 kHz
	RBW	30 kHz
	Sweep Time	5.7 s
	Auto Sweep Time Select	Normal
	Detection	Positive
	Trace Point	1001
	Filter Type	Rect
	Offset-1 Start Freq	0 Hz
	Offset-2 Start Freq	5.624 kHz
	Offset-3 Start Freq	12.5 kHz
	Offset-1 Stop Freq	5.624 kHz
	Offset-2 Stop Freq	12.5 kHz
	Offset-3 Stop Freq	25 kHz
	Offset-1 Reference Level	Auto
	Offset-2 Reference Level	Auto
	Offset-3 Reference Level	Auto
	Offset-1 RBW	100 Hz
	Offset-2 RBW	100 Hz
	Offset-3 RBW	100 Hz
	Offset-1 Sweep Time	2.9 s
	Offset-2 Sweep Time	3.5 s
	Offset-3 Sweep Time	6.3 s
	Offset-1 Auto Sweep Time Select	Normal
	Offset-2 Auto Sweep Time Select	Normal
	Offset-3 Auto Sweep Time Select	Normal
	Offset-1 Detection	Positive
	Offset-2 Detection	Positive
Offset-3 Detection	Positive	

Table C-5 Standard parameters for Spectrum Emission Mask (Cont'd)

Standard	Parameter Name	Setting
APCO P25 FCC 12.5kHz	Offset-1 Trace Point	1001
	Offset-2 Trace Point	1001
	Offset-3 Trace Point	1001
	Offset-1 On/Off	On
	Offset-2 On/Off	On
	Offset-3 On/Off	On
	Offset-4 On/Off	Off
	Offset-5 On/Off	Off
	Offset-6 On/Off	Off
	Limit-1 REL Start Level	0 dBm
	Limit-2 REL Start Level	-19.96 dBm
	Limit-3 REL Start Level	-70 dBm
	Limit-1 REL Stop Level	0 dBm
	Limit-2 REL Stop Level	-69.94 dBm
	Limit-3 REL Stop Level	-70 dBm
	Limit-1 Fail Logic	REL
	Limit-2 Fail Logic	REL
	Limit-3 Fail Logic	REL

Table C-5 Standard parameters for Spectrum Emission Mask (Cont'd)

Standard	Parameter Name	Setting
APCO P25 NTIA 12.5kHz	Limit Side	Both
	Noise Cancel	Off
	Reference Mode	Peak
	Channel BW	11.25 kHz
	RBW	30 kHz
	Sweep Time	5.7 s
	Auto Sweep Time Select	Normal
	Detection	Positive
	Trace Point	1001
	Filter Type	Rect
	Offset-1 Start Freq	0 Hz
	Offset-2 Start Freq	2.5 kHz
	Offset-3 Start Freq	12.5 kHz
	Offset-1 Stop Freq	2.5 kHz
	Offset-2 Stop Freq	12.5 kHz
	Offset-3 Stop Freq	25 kHz
	Offset-1 Reference Level	Auto
	Offset-2 Reference Level	Auto
	Offset-3 Reference Level	Auto
	Offset-1 RBW	300 Hz
	Offset-2 RBW	300 Hz
	Offset-3 RBW	300 Hz
	Offset-1 Sweep Time	1.3 s
	Offset-2 Sweep Time	5 s
	Offset-3 Sweep Time	6.3 s
	Offset-1 Auto Sweep Time Select	Normal
	Offset-2 Auto Sweep Time Select	Normal
	Offset-3 Auto Sweep Time Select	Normal
	Offset-1 Detection	Positive
	Offset-2 Detection	Positive
Offset-3 Detection	Positive	

Table C-5 Standard parameters for Spectrum Emission Mask (Cont'd)

Standard	Parameter Name	Setting
APCO P25 NTIA 12.5kHz	Offset-1 Trace Point	1001
	Offset-2 Trace Point	1001
	Offset-3 Trace Point	1001
	Offset-1 On/Off	On
	Offset-2 On/Off	On
	Offset-3 On/Off	On
	Offset-4 On/Off	Off
	Offset-5 On/Off	Off
	Offset-6 On/Off	Off
	Limit-1 REL Start Level	0 dBm
	Limit-2 REL Start Level	0 dBm
	Limit-3 REL Start Level	-70 dBm
	Limit-1 REL Stop Level	0 dBm
	Limit-2 REL Stop Level	-70 dBm
	Limit-3 REL Stop Level	-70 dBm
	Limit-1 Fail Logic	REL
	Limit-2 Fail Logic	REL
	Limit-3 Fail Logic	REL

Microlink ETSI CS: 7MHz

Table C-5 Standard parameters for Spectrum Emission Mask (Cont'd)

Standard	Parameter Name	Setting
Microlink ETSI CS:7MHz Class:2	Frequency Span	35 MHz
	Limit Side	Both
	Reference Mode	Peak
	Channel BW	1 kHz
	RBW	30 kHz
	VBW	300 Hz
	Sweep Time	Auto
	Auto Sweep Time Select	Fast
	Detection	Positive
	Trace Point	1001
	Filter Type	Root Nyquist
	Roll-off Factor	0.22
	Offset-1 Start Freq	0 Hz
	Offset-2 Start Freq	3.4 MHz
	Offset-3 Start Freq	4.2 MHz
	Offset-4 Start Freq	6.8 MHz
	Offset-5 Start Freq	12 MHz
	Offset-1 Stop Freq	3.4 MHz
	Offset-2 Stop Freq	4.2 MHz
	Offset-3 Stop Freq	6.8 MHz
	Offset-4 Stop Freq	12 MHz
	Offset-5 Stop Freq	17.5 MHz
	Offset-1 Reference Level	Auto
	Offset-2 Reference Level	Auto
	Offset-3 Reference Level	Auto
	Offset-4 Reference Level	Auto
	Offset-5 Reference Level	Auto
	Offset-1 RBW	30 kHz
	Offset-2 RBW	30 kHz
	Offset-3 RBW	30 kHz
	Offset-4 RBW	30 kHz
	Offset-5 RBW	30 kHz
Offset-1 VBW	300 Hz	
Offset-2 VBW	300 Hz	
Offset-3 VBW	300 Hz	
Offset-4 VBW	300 Hz	
Offset-5 VBW	300 Hz	

Table C-5 Standard parameters for Spectrum Emission Mask (Cont'd)

Standard	Parameter Name	Setting
Microlink ETSI CS:7MHz Class:2	Offset-1 Sweep Time	Auto
	Offset-2 Sweep Time	Auto
	Offset-3 Sweep Time	Auto
	Offset-4 Sweep Time	Auto
	Offset-5 Sweep Time	Auto
	Offset-1 Auto Sweep Time Select	Fast
	Offset-2 Auto Sweep Time Select	Fast
	Offset-3 Auto Sweep Time Select	Fast
	Offset-4 Auto Sweep Time Select	Fast
	Offset-5 Auto Sweep Time Select	Fast
	Offset-1 Detection	Positive
	Offset-2 Detection	Positive
	Offset-3 Detection	Positive
	Offset-4 Detection	Positive
	Offset-5 Detection	Positive
	Offset-1 Trace Point	1001
	Offset-2 Trace Point	1001
	Offset-3 Trace Point	1001
	Offset-4 Trace Point	1001
	Offset-5 Trace Point	1001
	Offset-1 On/Off	On
	Offset-2 On/Off	On
	Offset-3 On/Off	On
	Offset-4 On/Off	On
	Offset-5 On/Off	On
	Limit-1 REL Start Level	1.0 dB
	Limit-2 REL Start Level	1.0 dB
	Limit-3 REL Start Level	-23.0 dB
	Limit-4 REL Start Level	-23.0 dB
	Limit-5 REL Start Level	-45.0 dB

Table C-5 Standard parameters for Spectrum Emission Mask (Cont'd)

Standard	Parameter Name	Setting
Microlink ETSI CS:7MHz Class:2	Limit-1 REL Stop Level	1.0 dB
	Limit-2 REL Stop Level	-23.0 dB
	Limit-3 REL Stop Level	-23.0 dB
	Limit-4 REL Stop Level	-45.0 dB
	Limit-5 REL Stop Level	-45.0 dB
	Limit-1 Fail Logic	REL
	Limit-2 Fail Logic	REL
	Limit-3 Fail Logic	REL
	Limit-4 Fail Logic	REL
	Limit-5 Fail Logic	REL
	Limit-1 REL Stop Level	1.0 dB
	Limit-2 REL Stop Level	-23.0 dB
	Limit-3 REL Stop Level	-23.0 dB
	Limit-4 REL Stop Level	-45.0 dB
	Limit-5 REL Stop Level	-45.0 dB
	Limit-1 Fail Logic	REL
	Limit-2 Fail Logic	REL
	Limit-3 Fail Logic	REL
	Limit-4 Fail Logic	REL
	Limit-5 Fail Logic	REL

Table C-5 Standard parameters for Spectrum Emission Mask (Cont'd)

Standard	Parameter Name	Setting
Microlink ETSI CS:7MHz Class:4L Freq Band:3G - 17GHz	Frequency Span	35 MHz
	Limit Side	Both
	Reference Mode	Peak
	Channel BW	1 kHz
	RBW	30 kHz
	VBW	300 Hz
	Sweep Time	Auto
	Auto Sweep Time Select	Fast
	Detection	Positive
	Trace Point	1001
	Filter Type	Root Nyquist
	Roll-off Factor	0.22
	Offset-1 Start Freq	0 Hz
	Offset-2 Start Freq	3.2 MHz
	Offset-3 Start Freq	4.4 MHz
	Offset-4 Start Freq	14 MHz
	Offset-1 Stop Freq	3.2 MHz
	Offset-2 Stop Freq	4.4 MHz
	Offset-3 Stop Freq	14 MHz
	Offset-4 Stop Freq	17.5 MHz
	Offset-1 Reference Level	Auto
	Offset-2 Reference Level	Auto
	Offset-3 Reference Level	Auto
	Offset-4 Reference Level	Auto
	Offset-1 RBW	30 kHz
	Offset-2 RBW	30 kHz
	Offset-3 RBW	30 kHz
	Offset-4 RBW	30 kHz
	Offset-1 VBW	300 Hz
	Offset-2 VBW	300 Hz
	Offset-3 VBW	300 Hz
	Offset-4 VBW	300 Hz
Offset-1 Sweep Time	Auto	
Offset-2 Sweep Time	Auto	
Offset-3 Sweep Time	Auto	
Offset-4 Sweep Time	Auto	

Table C-5 Standard parameters for Spectrum Emission Mask (Cont'd)

Standard	Parameter Name	Setting
Microlink ETSI CS:7MHz Class:4L Freq Band:3G - 17GHz	Offset-1 Auto Sweep Time Select	Fast
	Offset-2 Auto Sweep Time Select	Fast
	Offset-3 Auto Sweep Time Select	Fast
	Offset-4 Auto Sweep Time Select	Fast
	Offset-1 Detection	Positive
	Offset-2 Detection	Positive
	Offset-3 Detection	Positive
	Offset-4 Detection	Positive
	Offset-1 Trace Point	1001
	Offset-2 Trace Point	1001
	Offset-3 Trace Point	1001
	Offset-4 Trace Point	1001
	Offset-1 On/Off	On
	Offset-2 On/Off	On
	Offset-3 On/Off	On
	Offset-4 On/Off	On
	Limit-1 REL Start Level	1.0 dB
	Limit-2 REL Start Level	1.0 dB
	Limit-3 REL Start Level	-28.0 dB
	Limit-4 REL Start Level	-55.0 dB
	Limit-1 REL Stop Level	1.0 dB
	Limit-2 REL Stop Level	-28.0 dB
	Limit-3 REL Stop Level	-55.0 dB
	Limit-4 REL Stop Level	-55.0 dB
	Limit-1 Fail Logic	REL
	Limit-2 Fail Logic	REL
	Limit-3 Fail Logic	REL
	Limit-4 Fail Logic	REL

Table C-5 Standard parameters for Spectrum Emission Mask (Cont'd)

Standard	Parameter Name	Setting
Microlink ETS CS:7MHz Class:4L Freq Band:17G - 30GHz	Frequency Span	35 MHz
	Limit Side	Both
	Reference Mode	Peak
	Channel BW	1 kHz
	RBW	30 kHz
	VBW	300 Hz
	Sweep Time	Auto
	Auto Sweep Time Select	Fast
	Detection	Positive
	Trace Point	1001
	Filter Type	Root Nyquist
	Roll-off Factor	0.22
	Offset-1 Start Freq	0 Hz
	Offset-2 Start Freq	3.2 MHz
	Offset-3 Start Freq	4.4 MHz
	Offset-4 Start Freq	12.4 MHz
	Offset-1 Stop Freq	3.2 MHz
	Offset-2 Stop Freq	4.4 MHz
	Offset-3 Stop Freq	12.4 MHz
	Offset-4 Stop Freq	17.5 MHz
	Offset-1 Reference Level	Auto
	Offset-2 Reference Level	Auto
	Offset-3 Reference Level	Auto
	Offset-4 Reference Level	Auto
	Offset-1 RBW	30 kHz
	Offset-2 RBW	30 kHz
	Offset-3 RBW	30 kHz
	Offset-4 RBW	30 kHz
	Offset-1 VBW	300 Hz
	Offset-2 VBW	300 Hz
	Offset-3 VBW	300 Hz
	Offset-4 VBW	300 Hz
Offset-1 Sweep Time	Auto	
Offset-2 Sweep Time	Auto	
Offset-3 Sweep Time	Auto	
Offset-4 Sweep Time	Auto	

Table C-5 Standard parameters for Spectrum Emission Mask (Cont'd)

Standard	Parameter Name	Setting
Microlink ETSI CS:7MHz Class:4L Freq Band:17G - 30GHz	Offset-1 Auto Sweep Time Select	Fast
	Offset-2 Auto Sweep Time Select	Fast
	Offset-3 Auto Sweep Time Select	Fast
	Offset-4 Auto Sweep Time Select	Fast
	Offset-1 Detection	Positive
	Offset-2 Detection	Positive
	Offset-3 Detection	Positive
	Offset-4 Detection	Positive
	Offset-1 Trace Point	1001
	Offset-2 Trace Point	1001
	Offset-3 Trace Point	1001
	Offset-4 Trace Point	1001
	Offset-1 On/Off	On
	Offset-2 On/Off	On
	Offset-3 On/Off	On
	Offset-4 On/Off	On
	Limit-1 REL Start Level	1.0 dB
	Limit-2 REL Start Level	1.0 dB
	Limit-3 REL Start Level	-28.0 dB
	Limit-4 REL Start Level	-50.0 dB
	Limit-1 REL Stop Level	1.0 dB
	Limit-2 REL Stop Level	-28.0 dB
	Limit-3 REL Stop Level	-50.0 dB
	Limit-4 REL Stop Level	-50.0 dB
	Limit-1 Fail Logic	REL
	Limit-2 Fail Logic	REL
	Limit-3 Fail Logic	REL
	Limit-4 Fail Logic	REL

Table C-5 Standard parameters for Spectrum Emission Mask (Cont'd)

Standard	Parameter Name	Setting
Microlink ETSI CS:7MHz Class:4L Freq Band:above 30GHz	Frequency Span	35 MHz
	Limit Side	Both
	Reference Mode	Peak
	Channel BW	1 kHz
	RBW	30 kHz
	VBW	300 Hz
	Sweep Time	Auto
	Auto Sweep Time Select	Fast
	Detection	Positive
	Trace Point	1001
	Filter Type	Root Nyquist
	Roll-off Factor	0.22
	Offset-1 Start Freq	0 Hz
	Offset-2 Start Freq	3.2 MHz
	Offset-3 Start Freq	4.4 MHz
	Offset-4 Start Freq	10.4 MHz
	Offset-1 Stop Freq	3.2 MHz
	Offset-2 Stop Freq	4.4 MHz
	Offset-3 Stop Freq	10.4 MHz
	Offset-4 Stop Freq	17.5 MHz
	Offset-1 Reference Level	Auto
	Offset-2 Reference Level	Auto
	Offset-3 Reference Level	Auto
	Offset-4 Reference Level	Auto
	Offset-1 RBW	30 kHz
	Offset-2 RBW	30 kHz
	Offset-3 RBW	30 kHz
	Offset-4 RBW	30 kHz
	Offset-1 VBW	300 Hz
	Offset-2 VBW	300 Hz
	Offset-3 VBW	300 Hz
	Offset-4 VBW	300 Hz
Offset-1 Sweep Time	Auto	
Offset-2 Sweep Time	Auto	
Offset-3 Sweep Time	Auto	
Offset-4 Sweep Time	Auto	

Table C-5 Standard parameters for Spectrum Emission Mask (Cont'd)

Standard	Parameter Name	Setting
Microlink ETSI CS:7MHz Class:4L Freq Band:above 30GHz	Offset-1 Auto Sweep Time Select	Fast
	Offset-2 Auto Sweep Time Select	Fast
	Offset-3 Auto Sweep Time Select	Fast
	Offset-4 Auto Sweep Time Select	Fast
	Offset-1 Detection	Positive
	Offset-2 Detection	Positive
	Offset-3 Detection	Positive
	Offset-4 Detection	Positive
	Offset-1 Trace Point	1001
	Offset-2 Trace Point	1001
	Offset-3 Trace Point	1001
	Offset-4 Trace Point	1001
	Offset-1 On/Off	On
	Offset-2 On/Off	On
	Offset-3 On/Off	On
	Offset-4 On/Off	On
	Limit-1 REL Start Level	1.0 dB
	Limit-2 REL Start Level	1.0 dB
	Limit-3 REL Start Level	-28.0 dB
	Limit-4 REL Start Level	-45.0 dB
	Limit-1 REL Stop Level	1.0 dB
	Limit-2 REL Stop Level	-28.0 dB
	Limit-3 REL Stop Level	-45.0 dB
	Limit-4 REL Stop Level	-45.0 dB
	Limit-1 Fail Logic	REL
	Limit-2 Fail Logic	REL
	Limit-3 Fail Logic	REL
	Limit-4 Fail Logic	REL

Table C-5 Standard parameters for Spectrum Emission Mask (Cont'd)

Standard	Parameter Name	Setting
Microlink ETS CS:7MHz Class:5B Freq Band:3G - 17GHz	Frequency Span	35 MHz
	Limit Side	Both
	Reference Mode	Peak
	Channel BW	1 kHz
	RBW	30 kHz
	VBW	300 Hz
	Sweep Time	Auto
	Auto Sweep Time Select	Fast
	Detection	Positive
	Trace Point	1001
	Filter Type	Root Nyquist
	Roll-off Factor	0.22
	Offset-1 Start Freq	0 Hz
	Offset-2 Start Freq	3 MHz
	Offset-3 Start Freq	3.625 MHz
	Offset-4 Start Freq	3.875 MHz
	Offset-5 Start Freq	4.25 MHz
	Offset-6 Start Freq	10 MHz
	Offset-7 Start Freq	13.5 MHz
	Offset-1 Stop Freq	3 MHz
	Offset-2 Stop Freq	3.625 MHz
	Offset-3 Stop Freq	3.875 MHz
	Offset-4 Stop Freq	4.25 MHz
	Offset-5 Stop Freq	10 MHz
	Offset-6 Stop Freq	13.5 MHz
	Offset-7 Stop Freq	17.5 MHz
	Offset-1 Reference Level	Auto
	Offset-2 Reference Level	Auto
	Offset-3 Reference Level	Auto
	Offset-4 Reference Level	Auto
	Offset-5 Reference Level	Auto
	Offset-6 Reference Level	Auto
	Offset-7 Reference Level	Auto
Offset-1 RBW	30 kHz	
Offset-2 RBW	30 kHz	
Offset-3 RBW	30 kHz	
Offset-4 RBW	30 kHz	
Offset-5 RBW	30 kHz	
Offset-6 RBW	30 kHz	
Offset-7 RBW	30 kHz	

Table C-5 Standard parameters for Spectrum Emission Mask (Cont'd)

Standard	Parameter Name	Setting
Microlink ETSI CS:7MHz Class:5B Freq Band:3G - 17GHz	Offset-1 VBW	300 Hz
	Offset-2 VBW	300 Hz
	Offset-3 VBW	300 Hz
	Offset-4 VBW	300 Hz
	Offset-5 VBW	300 Hz
	Offset-6 VBW	300 Hz
	Offset-7 VBW	300 Hz
	Offset-1 Sweep Time	Auto
	Offset-2 Sweep Time	Auto
	Offset-3 Sweep Time	Auto
	Offset-4 Sweep Time	Auto
	Offset-5 Sweep Time	Auto
	Offset-6 Sweep Time	Auto
	Offset-7 Sweep Time	Auto
	Offset-1 Auto Sweep Time Select	Fast
	Offset-2 Auto Sweep Time Select	Fast
	Offset-3 Auto Sweep Time Select	Fast
	Offset-4 Auto Sweep Time Select	Fast
	Offset-5 Auto Sweep Time Select	Fast
	Offset-6 Auto Sweep Time Select	Fast
	Offset-7 Auto Sweep Time Select	Fast
	Offset-1 Detection	Positive
	Offset-2 Detection	Positive
	Offset-3 Detection	Positive
	Offset-4 Detection	Positive
	Offset-5 Detection	Positive
	Offset-6 Detection	Positive
	Offset-7 Detection	Positive

Table C-5 Standard parameters for Spectrum Emission Mask (Cont'd)

Standard	Parameter Name	Setting
Microlink ETSI CS:7MHz Class:5B Freq Band:3G - 17GHz	Offset-1 Trace Point	1001
	Offset-2 Trace Point	1001
	Offset-3 Trace Point	1001
	Offset-4 Trace Point	1001
	Offset-5 Trace Point	1001
	Offset-6 Trace Point	1001
	Offset-7 Trace Point	1001
	Offset-1 On/Off	On
	Offset-2 On/Off	On
	Offset-3 On/Off	On
	Offset-4 On/Off	On
	Offset-5 On/Off	On
	Offset-6 On/Off	On
	Offset-7 On/Off	On
	Limit-1 REL Start Level	1.0 dB
	Limit-2 REL Start Level	1.0 dB
	Limit-3 REL Start Level	-10.0 dB
	Limit-4 REL Start Level	-32.0 dB
	Limit-5 REL Start Level	-36.0 dB
	Limit-6 REL Start Level	-45.0 dB
	Limit-7 REL Start Level	-55.0 dB
	Limit-1 REL Stop Level	1.0 dB
	Limit-2 REL Stop Level	-10.0 dB
	Limit-3 REL Stop Level	-32.0 dB
	Limit-4 REL Stop Level	-36.0 dB
	Limit-5 REL Stop Level	-45.0 dB
	Limit-6 REL Stop Level	-55.0 dB
	Limit-7 REL Stop Level	-55.0 dB
	Limit-1 Fail Logic	REL
	Limit-2 Fail Logic	REL
	Limit-3 Fail Logic	REL
Limit-4 Fail Logic	REL	
Limit-5 Fail Logic	REL	
Limit-6 Fail Logic	REL	
Limit-7 Fail Logic	REL	

Table C-5 Standard parameters for Spectrum Emission Mask (Cont'd)

Standard	Parameter Name	Setting
Microlink ETSI CS:7MHz Class:5B Freq Band:17G - 30GHz	Frequency Span	35 MHz
	Limit Side	Both
	Reference Mode	Peak
	Channel BW	1 kHz
	RBW	30 kHz
	VBW	300 Hz
	Sweep Time	Auto
	Auto Sweep Time Select	Fast
	Detection	Positive
	Trace Point	1001
	Filter Type	Root Nyquist
	Roll-off Factor	0.22
	Offset-1 Start Freq	0 Hz
	Offset-2 Start Freq	3 MHz
	Offset-3 Start Freq	3.625 MHz
	Offset-4 Start Freq	3.875 MHz
	Offset-5 Start Freq	4.25 MHz
	Offset-6 Start Freq	10 MHz
	Offset-7 Start Freq	11.75 MHz
	Offset-1 Stop Freq	3 MHz
	Offset-2 Stop Freq	3.625 MHz
	Offset-3 Stop Freq	3.875 MHz
	Offset-4 Stop Freq	4.25 MHz
	Offset-5 Stop Freq	10 MHz
	Offset-6 Stop Freq	11.75 MHz
	Offset-7 Stop Freq	17.5 MHz
	Offset-1 Reference Level	Auto
	Offset-2 Reference Level	Auto
	Offset-3 Reference Level	Auto
	Offset-4 Reference Level	Auto
	Offset-5 Reference Level	Auto
	Offset-6 Reference Level	Auto
Offset-7 Reference Level	Auto	
Offset-1 RBW	30 kHz	
Offset-2 RBW	30 kHz	
Offset-3 RBW	30 kHz	
Offset-4 RBW	30 kHz	
Offset-5 RBW	30 kHz	
Offset-6 RBW	30 kHz	
Offset-7 RBW	30 kHz	

Table C-5 Standard parameters for Spectrum Emission Mask (Cont'd)

Standard	Parameter Name	Setting
Microlink ETSI CS:7MHz Class:5B Freq Band:17G - 30GHz	Offset-1 VBW	300 Hz
	Offset-2 VBW	300 Hz
	Offset-3 VBW	300 Hz
	Offset-4 VBW	300 Hz
	Offset-5 VBW	300 Hz
	Offset-6 VBW	300 Hz
	Offset-7 VBW	300 Hz
	Offset-1 Sweep Time	Auto
	Offset-2 Sweep Time	Auto
	Offset-3 Sweep Time	Auto
	Offset-4 Sweep Time	Auto
	Offset-5 Sweep Time	Auto
	Offset-6 Sweep Time	Auto
	Offset-7 Sweep Time	Auto
	Offset-1 Auto Sweep Time Select	Fast
	Offset-2 Auto Sweep Time Select	Fast
	Offset-3 Auto Sweep Time Select	Fast
	Offset-4 Auto Sweep Time Select	Fast
	Offset-5 Auto Sweep Time Select	Fast
	Offset-6 Auto Sweep Time Select	Fast
	Offset-7 Auto Sweep Time Select	Fast
	Offset-1 Detection	Positive
	Offset-2 Detection	Positive
	Offset-3 Detection	Positive
	Offset-4 Detection	Positive
	Offset-5 Detection	Positive
	Offset-6 Detection	Positive
	Offset-7 Detection	Positive

Table C-5 Standard parameters for Spectrum Emission Mask (Cont'd)

Standard	Parameter Name	Setting
Microlink ETSI CS:7MHz Class:5B Freq Band:17G - 30GHz	Offset-1 Trace Point	1001
	Offset-2 Trace Point	1001
	Offset-3 Trace Point	1001
	Offset-4 Trace Point	1001
	Offset-5 Trace Point	1001
	Offset-6 Trace Point	1001
	Offset-7 Trace Point	1001
	Offset-1 On/Off	On
	Offset-2 On/Off	On
	Offset-3 On/Off	On
	Offset-4 On/Off	On
	Offset-5 On/Off	On
	Offset-6 On/Off	On
	Offset-7 On/Off	On
	Limit-1 REL Start Level	1.0 dB
	Limit-2 REL Start Level	1.0 dB
	Limit-3 REL Start Level	-10.0 dB
	Limit-4 REL Start Level	-32.0 dB
	Limit-5 REL Start Level	-36.0 dB
	Limit-6 REL Start Level	-45.0 dB
	Limit-7 REL Start Level	-50.0 dB
	Limit-1 REL Stop Level	1.0 dB
	Limit-2 REL Stop Level	-10.0 dB
	Limit-3 REL Stop Level	-32.0 dB
	Limit-4 REL Stop Level	-36.0 dB
	Limit-5 REL Stop Level	-45.0 dB
	Limit-6 REL Stop Level	-50.0 dB
	Limit-7 REL Stop Level	-50.0 dB
	Limit-1 Fail Logic	REL
	Limit-2 Fail Logic	REL
	Limit-3 Fail Logic	REL
Limit-4 Fail Logic	REL	
Limit-5 Fail Logic	REL	
Limit-6 Fail Logic	REL	
Limit-7 Fail Logic	REL	

Table C-5 Standard parameters for Spectrum Emission Mask (Cont'd)

Standard	Parameter Name	Setting
Microlink ETSI CS:7MHz Class:5B Freq Band:above 30GHz	Frequency Span	35 MHz
	Limit Side	Both
	Reference Mode	Peak
	Channel BW	1 kHz
	RBW	30 kHz
	VBW	300 Hz
	Sweep Time	Auto
	Auto Sweep Time Select	Fast
	Detection	Positive
	Trace Point	1001
	Filter Type	Root Nyquist
	Roll-off Factor	0.22
	Offset-1 Start Freq	0 Hz
	Offset-2 Start Freq	3 MHz
	Offset-3 Start Freq	3.625 MHz
	Offset-4 Start Freq	3.875 MHz
	Offset-5 Start Freq	4.25 MHz
	Offset-6 Start Freq	10 MHz
	Offset-1 Stop Freq	3 MHz
	Offset-2 Stop Freq	3.625 MHz
	Offset-3 Stop Freq	3.875 MHz
	Offset-4 Stop Freq	4.25 MHz
	Offset-5 Stop Freq	10 MHz
	Offset-6 Stop Freq	17.5 MHz
	Offset-1 Reference Level	Auto
	Offset-2 Reference Level	Auto
	Offset-3 Reference Level	Auto
	Offset-4 Reference Level	Auto
	Offset-5 Reference Level	Auto
	Offset-6 Reference Level	Auto
Offset-1 RBW	30 kHz	
Offset-2 RBW	30 kHz	
Offset-3 RBW	30 kHz	
Offset-4 RBW	30 kHz	
Offset-5 RBW	30 kHz	
Offset-6 RBW	30 kHz	

Table C-5 Standard parameters for Spectrum Emission Mask (Cont'd)

Standard	Parameter Name	Setting
Microlink ETSI CS:7MHz Class:5B Freq Band:above 30GHz	Offset-1 VBW	300 Hz
	Offset-2 VBW	300 Hz
	Offset-3 VBW	300 Hz
	Offset-4 VBW	300 Hz
	Offset-5 VBW	300 Hz
	Offset-6 VBW	300 Hz
	Offset-1 Sweep Time	Auto
	Offset-2 Sweep Time	Auto
	Offset-3 Sweep Time	Auto
	Offset-4 Sweep Time	Auto
	Offset-5 Sweep Time	Auto
	Offset-6 Sweep Time	Auto
	Offset-1 Auto Sweep Time Select	Fast
	Offset-2 Auto Sweep Time Select	Fast
	Offset-3 Auto Sweep Time Select	Fast
	Offset-4 Auto Sweep Time Select	Fast
	Offset-5 Auto Sweep Time Select	Fast
	Offset-6 Auto Sweep Time Select	Fast
	Offset-1 Detection	Positive
	Offset-2 Detection	Positive
	Offset-3 Detection	Positive
	Offset-4 Detection	Positive
	Offset-5 Detection	Positive
	Offset-6 Detection	Positive
	Offset-1 Trace Point	1001
	Offset-2 Trace Point	1001
	Offset-3 Trace Point	1001
	Offset-4 Trace Point	1001
Offset-5 Trace Point	1001	
Offset-6 Trace Point	1001	

Table C-5 Standard parameters for Spectrum Emission Mask (Cont'd)

Standard	Parameter Name	Setting
Microlink ETSI CS:7MHz Class:5B Freq Band:above 30GHz	Offset-1 On/Off	On
	Offset-2 On/Off	On
	Offset-3 On/Off	On
	Offset-4 On/Off	On
	Offset-5 On/Off	On
	Offset-6 On/Off	On
	Limit-1 REL Start Level	1.0 dB
	Limit-2 REL Start Level	1.0 dB
	Limit-3 REL Start Level	-10.0 dB
	Limit-4 REL Start Level	-32.0 dB
	Limit-5 REL Start Level	-36.0 dB
	Limit-6 REL Start Level	-45.0 dB
	Limit-1 REL Stop Level	1.0 dB
	Limit-2 REL Stop Level	-10.0 dB
	Limit-3 REL Stop Level	-32.0 dB
	Limit-4 REL Stop Level	-36.0 dB
	Limit-5 REL Stop Level	-45.0 dB
	Limit-6 REL Stop Level	-45.0 dB
	Limit-1 Fail Logic	REL
	Limit-2 Fail Logic	REL
	Limit-3 Fail Logic	REL
	Limit-4 Fail Logic	REL
	Limit-5 Fail Logic	REL
	Limit-6 Fail Logic	REL

Microlink ETSI CS: 14MHz

Table C-5 Standard parameters for Spectrum Emission Mask (Cont'd)

Standard	Parameter Name	Setting
Microlink ETSI CS:14MHz Class:2	Frequency Span	70 MHz
	Limit Side	Both
	Reference Mode	Peak
	Channel BW	1 kHz
	RBW	100 kHz
	VBW	300 Hz
	Sweep Time	Auto
	Auto Sweep Time Select	Fast
	Detection	Positive
	Trace Point	1001
	Filter Type	Root Nyquist
	Roll-off Factor	0.22
	Offset-1 Start Freq	0 Hz
	Offset-2 Start Freq	6.8 MHz
	Offset-3 Start Freq	8.4 MHz
	Offset-4 Start Freq	13.6 MHz
	Offset-5 Start Freq	24 MHz
	Offset-1 Stop Freq	6.8 MHz
	Offset-2 Stop Freq	8.4 MHz
	Offset-3 Stop Freq	13.6 MHz
	Offset-4 Stop Freq	24 MHz
	Offset-5 Stop Freq	35 MHz
	Offset-1 Reference Level	Auto
	Offset-2 Reference Level	Auto
	Offset-3 Reference Level	Auto
	Offset-4 Reference Level	Auto
	Offset-5 Reference Level	Auto
	Offset-1 RBW	100 kHz
	Offset-2 RBW	100 kHz
	Offset-3 RBW	100 kHz
	Offset-4 RBW	100 kHz
	Offset-5 RBW	100 kHz
Offset-1 VBW	300 Hz	
Offset-2 VBW	300 Hz	
Offset-3 VBW	300 Hz	
Offset-4 VBW	300 Hz	
Offset-5 VBW	300 Hz	

Table C-5 Standard parameters for Spectrum Emission Mask (Cont'd)

Standard	Parameter Name	Setting
Microlink ETSI CS:14MHz Class:2	Offset-1 Sweep Time	Auto
	Offset-2 Sweep Time	Auto
	Offset-3 Sweep Time	Auto
	Offset-4 Sweep Time	Auto
	Offset-5 Sweep Time	Auto
	Offset-1 Auto Sweep Time Select	Fast
	Offset-2 Auto Sweep Time Select	Fast
	Offset-3 Auto Sweep Time Select	Fast
	Offset-4 Auto Sweep Time Select	Fast
	Offset-5 Auto Sweep Time Select	Fast
	Offset-1 Detection	Positive
	Offset-2 Detection	Positive
	Offset-3 Detection	Positive
	Offset-4 Detection	Positive
	Offset-5 Detection	Positive
	Offset-1 Trace Point	1001
	Offset-2 Trace Point	1001
	Offset-3 Trace Point	1001
	Offset-4 Trace Point	1001
	Offset-5 Trace Point	1001
	Offset-1 On/Off	On
	Offset-2 On/Off	On
	Offset-3 On/Off	On
	Offset-4 On/Off	On
	Offset-5 On/Off	On
	Limit-1 REL Start Level	1.0 dB
	Limit-2 REL Start Level	1.0 dB
	Limit-3 REL Start Level	-23.0 dB
	Limit-4 REL Start Level	-23.0 dB
	Limit-5 REL Start Level	-45.0 dB
	Limit-1 REL Stop Level	1.0 dB
	Limit-2 REL Stop Level	-23.0 dB
Limit-3 REL Stop Level	-23.0 dB	
Limit-4 REL Stop Level	-45.0 dB	
Limit-5 REL Stop Level	-45.0 dB	

Table C-5 Standard parameters for Spectrum Emission Mask (Cont'd)

Standard	Parameter Name	Setting
Microlink ETSI CS:14MHz Class:2	Limit-1 Fail Logic	REL
	Limit-2 Fail Logic	REL
	Limit-3 Fail Logic	REL
	Limit-4 Fail Logic	REL
	Limit-5 Fail Logic	REL

Table C-5 Standard parameters for Spectrum Emission Mask (Cont'd)

Standard	Parameter Name	Setting
Microlink ETSI CS:14MHz Class:4L Freq Band:3G - 17GHz	Frequency Span	70 MHz
	Limit Side	Both
	Reference Mode	Peak
	Channel BW	1 kHz
	RBW	100 kHz
	VBW	300 Hz
	Sweep Time	Auto
	Auto Sweep Time Select	Fast
	Detection	Positive
	Trace Point	1001
	Filter Type	Root Nyquist
	Roll-off Factor	0.22
	Offset-1 Start Freq	0 Hz
	Offset-2 Start Freq	6.4 MHz
	Offset-3 Start Freq	8.8 MHz
	Offset-4 Start Freq	28 MHz
	Offset-1 Stop Freq	6.4 MHz
	Offset-2 Stop Freq	8.8 MHz
	Offset-3 Stop Freq	28 MHz
	Offset-4 Stop Freq	35 MHz
	Offset-1 Reference Level	Auto
	Offset-2 Reference Level	Auto
	Offset-3 Reference Level	Auto
	Offset-4 Reference Level	Auto
	Offset-1 RBW	100 kHz
	Offset-2 RBW	100 kHz
	Offset-3 RBW	100 kHz
	Offset-4 RBW	100 kHz
	Offset-1 VBW	300 Hz
	Offset-2 VBW	300 Hz
	Offset-3 VBW	300 Hz
	Offset-4 VBW	300 Hz
Offset-1 Sweep Time	Auto	
Offset-2 Sweep Time	Auto	
Offset-3 Sweep Time	Auto	
Offset-4 Sweep Time	Auto	

Table C-5 Standard parameters for Spectrum Emission Mask (Cont'd)

Standard	Parameter Name	Setting
Microlink ETSI CS:14MHz Class:4L Freq Band:3G - 17GHz	Offset-1 Detection	Positive
	Offset-2 Detection	Positive
	Offset-3 Detection	Positive
	Offset-4 Detection	Positive
	Offset-1 Trace Point	1001
	Offset-2 Trace Point	1001
	Offset-3 Trace Point	1001
	Offset-4 Trace Point	1001
	Offset-1 On/Off	On
	Offset-2 On/Off	On
	Offset-3 On/Off	On
	Offset-4 On/Off	On
	Limit-1 REL Start Level	1.0 dB
	Limit-2 REL Start Level	1.0 dB
	Limit-3 REL Start Level	-28.0 dB
	Limit-4 REL Start Level	-55.0 dB
	Limit-1 REL Stop Level	1.0 dB
	Limit-2 REL Stop Level	-28.0 dB
	Limit-3 REL Stop Level	-55.0 dB
	Limit-4 REL Stop Level	-55.0 dB
Limit-1 Fail Logic	REL	
Limit-2 Fail Logic	REL	
Limit-3 Fail Logic	REL	
Limit-4 Fail Logic	REL	

Table C-5 Standard parameters for Spectrum Emission Mask (Cont'd)

Standard	Parameter Name	Setting
Microlink ETSI CS:14MHz Class:4L Freq Band:17G - 30GHz	Frequency Span	70 MHz
	Limit Side	Both
	Reference Mode	Peak
	Channel BW	1 kHz
	RBW	100 kHz
	VBW	300 Hz
	Sweep Time	Auto
	Auto Sweep Time Select	Fast
	Detection	Positive
	Trace Point	1001
	Filter Type	Root Nyquist
	Roll-off Factor	0.22
	Offset-1 Start Freq	0 Hz
	Offset-2 Start Freq	6.4 MHz
	Offset-3 Start Freq	8.8 MHz
	Offset-4 Start Freq	24.8 MHz
	Offset-1 Stop Freq	6.4 MHz
	Offset-2 Stop Freq	8.8 MHz
	Offset-3 Stop Freq	24.8 MHz
	Offset-4 Stop Freq	35 MHz
	Offset-1 Reference Level	Auto
	Offset-2 Reference Level	Auto
	Offset-3 Reference Level	Auto
	Offset-4 Reference Level	Auto
	Offset-1 RBW	100 kHz
	Offset-2 RBW	100 kHz
	Offset-3 RBW	100 kHz
	Offset-4 RBW	100 kHz
	Offset-1 VBW	300 Hz
	Offset-2 VBW	300 Hz
	Offset-3 VBW	300 Hz
	Offset-4 VBW	300 Hz
Offset-1 Sweep Time	Auto	
Offset-2 Sweep Time	Auto	
Offset-3 Sweep Time	Auto	
Offset-4 Sweep Time	Auto	

Table C-5 Standard parameters for Spectrum Emission Mask (Cont'd)

Standard	Parameter Name	Setting
Microlink ETSI CS:14MHz Class:4L Freq Band:17G - 30GHz	Offset-1 Detection	Positive
	Offset-2 Detection	Positive
	Offset-3 Detection	Positive
	Offset-4 Detection	Positive
	Offset-1 Trace Point	1001
	Offset-2 Trace Point	1001
	Offset-3 Trace Point	1001
	Offset-4 Trace Point	1001
	Offset-1 On/Off	On
	Offset-2 On/Off	On
	Offset-3 On/Off	On
	Offset-4 On/Off	On
	Limit-1 REL Start Level	1.0 dB
	Limit-2 REL Start Level	1.0 dB
	Limit-3 REL Start Level	-28.0 dB
	Limit-4 REL Start Level	-50.0 dB
	Limit-1 REL Stop Level	1.0 dB
	Limit-2 REL Stop Level	-28.0 dB
	Limit-3 REL Stop Level	-50.0 dB
	Limit-4 REL Stop Level	-50.0 dB
Limit-1 Fail Logic	REL	
Limit-2 Fail Logic	REL	
Limit-3 Fail Logic	REL	
Limit-4 Fail Logic	REL	

Table C-5 Standard parameters for Spectrum Emission Mask (Cont'd)

Standard	Parameter Name	Setting
Microlink ETSI CS:14MHz Class:4L Freq Band:above 30GHz	Frequency Span	70 MHz
	Limit Side	Both
	Reference Mode	Peak
	Channel BW	1 kHz
	RBW	100 kHz
	VBW	300 Hz
	Sweep Time	Auto
	Auto Sweep Time Select	Fast
	Detection	Positive
	Trace Point	1001
	Filter Type	Root Nyquist
	Roll-off Factor	0.22
	Offset-1 Start Freq	0 Hz
	Offset-2 Start Freq	6.4 MHz
	Offset-3 Start Freq	8.8 MHz
	Offset-4 Start Freq	20.8 MHz
	Offset-1 Stop Freq	6.4 MHz
	Offset-2 Stop Freq	8.8 MHz
	Offset-3 Stop Freq	20.8 MHz
	Offset-4 Stop Freq	35 MHz
	Offset-1 Reference Level	Auto
	Offset-2 Reference Level	Auto
	Offset-3 Reference Level	Auto
	Offset-4 Reference Level	Auto
	Offset-1 RBW	100 kHz
	Offset-2 RBW	100 kHz
	Offset-3 RBW	100 kHz
	Offset-4 RBW	100 kHz
	Offset-1 VBW	300 Hz
	Offset-2 VBW	300 Hz
	Offset-3 VBW	300 Hz
	Offset-4 VBW	300 Hz
Offset-1 Sweep Time	Auto	
Offset-2 Sweep Time	Auto	
Offset-3 Sweep Time	Auto	
Offset-4 Sweep Time	Auto	

Table C-5 Standard parameters for Spectrum Emission Mask (Cont'd)

Standard	Parameter Name	Setting
Microlink ETSI CS:14MHz Class:4L Freq Band:above 30GHz	Offset-1 Auto Sweep Time Select	Fast
	Offset-2 Auto Sweep Time Select	Fast
	Offset-3 Auto Sweep Time Select	Fast
	Offset-4 Auto Sweep Time Select	Fast
	Offset-1 Detection	Positive
	Offset-2 Detection	Positive
	Offset-3 Detection	Positive
	Offset-4 Detection	Positive
	Offset-1 Trace Point	1001
	Offset-2 Trace Point	1001
	Offset-3 Trace Point	1001
	Offset-4 Trace Point	1001
	Offset-1 On/Off	On
	Offset-2 On/Off	On
	Offset-3 On/Off	On
	Offset-4 On/Off	On
	Limit-1 REL Start Level	1.0 dB
	Limit-2 REL Start Level	1.0 dB
	Limit-3 REL Start Level	-28.0 dB
	Limit-4 REL Start Level	-45.0 dB
	Limit-1 REL Stop Level	1.0 dB
	Limit-2 REL Stop Level	-28.0 dB
	Limit-3 REL Stop Level	-45.0 dB
	Limit-4 REL Stop Level	-45.0 dB
	Limit-1 Fail Logic	REL
	Limit-2 Fail Logic	REL
	Limit-3 Fail Logic	REL
	Limit-4 Fail Logic	REL

Table C-5 Standard parameters for Spectrum Emission Mask (Cont'd)

Standard	Parameter Name	Setting
Microlink ETSI CS:14MHz Class:5B Freq Band:3G - 17GHz	Frequency Span	70 MHz
	Limit Side	Both
	Reference Mode	Peak
	Channel BW	1 kHz
	RBW	100 kHz
	VBW	300 Hz
	Sweep Time	Auto
	Auto Sweep Time Select	Fast
	Detection	Positive
	Trace Point	1001
	Filter Type	Root Nyquist
	Roll-off Factor	0.22
	Offset-1 Start Freq	0 Hz
	Offset-2 Start Freq	6 MHz
	Offset-3 Start Freq	7.25 MHz
	Offset-4 Start Freq	7.75 MHz
	Offset-5 Start Freq	8.5 MHz
	Offset-6 Start Freq	20 MHz
	Offset-7 Start Freq	27 MHz
	Offset-1 Stop Freq	6 MHz
	Offset-2 Stop Freq	7.25 MHz
	Offset-3 Stop Freq	7.75 MHz
	Offset-4 Stop Freq	8.5 MHz
	Offset-5 Stop Freq	20 MHz
	Offset-6 Stop Freq	27 MHz
	Offset-7 Stop Freq	35 MHz
	Offset-1 Reference Level	Auto
	Offset-2 Reference Level	Auto
	Offset-3 Reference Level	Auto
	Offset-4 Reference Level	Auto
	Offset-5 Reference Level	Auto
	Offset-6 Reference Level	Auto
	Offset-7 Reference Level	Auto
Offset-1 RBW	100 kHz	
Offset-2 RBW	100 kHz	
Offset-3 RBW	100 kHz	
Offset-4 RBW	100 kHz	
Offset-5 RBW	100 kHz	
Offset-6 RBW	100 kHz	
Offset-7 RBW	100 kHz	

Table C-5 Standard parameters for Spectrum Emission Mask (Cont'd)

Standard	Parameter Name	Setting
Microlink ETSI CS:14MHz Class:5B Freq Band:3G - 17GHz	Offset-1 VBW	300 Hz
	Offset-2 VBW	300 Hz
	Offset-3 VBW	300 Hz
	Offset-4 VBW	300 Hz
	Offset-5 VBW	300 Hz
	Offset-6 VBW	300 Hz
	Offset-7 VBW	300 Hz
	Offset-1 Sweep Time	Auto
	Offset-2 Sweep Time	Auto
	Offset-3 Sweep Time	Auto
	Offset-4 Sweep Time	Auto
	Offset-5 Sweep Time	Auto
	Offset-6 Sweep Time	Auto
	Offset-7 Sweep Time	Auto
	Offset-1 Auto Sweep Time Select	Fast
	Offset-2 Auto Sweep Time Select	Fast
	Offset-3 Auto Sweep Time Select	Fast
	Offset-4 Auto Sweep Time Select	Fast
	Offset-5 Auto Sweep Time Select	Fast
	Offset-6 Auto Sweep Time Select	Fast
	Offset-7 Auto Sweep Time Select	Fast
	Offset-1 Detection	Positive
	Offset-2 Detection	Positive
	Offset-3 Detection	Positive
	Offset-4 Detection	Positive
	Offset-5 Detection	Positive
	Offset-6 Detection	Positive
	Offset-7 Detection	Positive

Table C-5 Standard parameters for Spectrum Emission Mask (Cont'd)

Standard	Parameter Name	Setting
Microlink ETSI CS:14MHz Class:5B Freq Band:3G - 17GHz	Offset-1 Trace Point	1001
	Offset-2 Trace Point	1001
	Offset-3 Trace Point	1001
	Offset-4 Trace Point	1001
	Offset-5 Trace Point	1001
	Offset-6 Trace Point	1001
	Offset-7 Trace Point	1001
	Offset-1 On/Off	On
	Offset-2 On/Off	On
	Offset-3 On/Off	On
	Offset-4 On/Off	On
	Offset-5 On/Off	On
	Offset-6 On/Off	On
	Offset-7 On/Off	On
	Limit-1 REL Start Level	1.0 dB
	Limit-2 REL Start Level	1.0 dB
	Limit-3 REL Start Level	-10.0 dB
	Limit-4 REL Start Level	-32.0 dB
	Limit-5 REL Start Level	-36.0 dB
	Limit-6 REL Start Level	-45.0 dB
	Limit-7 REL Start Level	-55.0 dB
	Limit-1 REL Stop Level	1.0 dB
	Limit-2 REL Stop Level	-10.0 dB
	Limit-3 REL Stop Level	-32.0 dB
	Limit-4 REL Stop Level	-36.0 dB
	Limit-5 REL Stop Level	-45.0 dB
	Limit-6 REL Stop Level	-55.0 dB
	Limit-7 REL Stop Level	-55.0 dB
	Limit-1 Fail Logic	REL
	Limit-2 Fail Logic	REL
	Limit-3 Fail Logic	REL
Limit-4 Fail Logic	REL	
Limit-5 Fail Logic	REL	
Limit-6 Fail Logic	REL	
Limit-7 Fail Logic	REL	

Appendix

Appendix C

Table C-5 Standard parameters for Spectrum Emission Mask (Cont'd)

Standard	Parameter Name	Setting
Microlink ETSI CS:14MHz Class:5B Freq Band:17G - 30GHz	Frequency Span	70 MHz
	Limit Side	Both
	Reference Mode	Peak
	Channel BW	1 kHz
	RBW	100 kHz
	VBW	300 Hz
	Sweep Time	Auto
	Auto Sweep Time Select	Fast
	Detection	Positive
	Trace Point	1001
	Filter Type	Root Nyquist
	Roll-off Factor	0.22
	Offset-1 Start Freq	0 Hz
	Offset-2 Start Freq	6 MHz
	Offset-3 Start Freq	7.25 MHz
	Offset-4 Start Freq	7.75 MHz
	Offset-5 Start Freq	8.5 MHz
	Offset-6 Start Freq	20 MHz
	Offset-7 Start Freq	23.5 MHz
	Offset-1 Stop Freq	6 MHz
	Offset-2 Stop Freq	7.25 MHz
	Offset-3 Stop Freq	7.75 MHz
	Offset-4 Stop Freq	8.5 MHz
	Offset-5 Stop Freq	20 MHz
	Offset-6 Stop Freq	23.5 MHz
	Offset-7 Stop Freq	35 MHz
	Offset-1 Reference Level	Auto
	Offset-2 Reference Level	Auto
	Offset-3 Reference Level	Auto
	Offset-4 Reference Level	Auto
	Offset-5 Reference Level	Auto
	Offset-6 Reference Level	Auto
	Offset-7 Reference Level	Auto
Offset-1 RBW	100 kHz	
Offset-2 RBW	100 kHz	
Offset-3 RBW	100 kHz	
Offset-4 RBW	100 kHz	
Offset-5 RBW	100 kHz	
Offset-6 RBW	100 kHz	
Offset-7 RBW	100 kHz	

Table C-5 Standard parameters for Spectrum Emission Mask (Cont'd)

Standard	Parameter Name	Setting
Microlink ETSI CS:14MHz Class:5B Freq Band:17G - 30GHz	Offset-1 VBW	300 Hz
	Offset-2 VBW	300 Hz
	Offset-3 VBW	300 Hz
	Offset-4 VBW	300 Hz
	Offset-5 VBW	300 Hz
	Offset-6 VBW	300 Hz
	Offset-7 VBW	300 Hz
	Offset-1 Sweep Time	Auto
	Offset-2 Sweep Time	Auto
	Offset-3 Sweep Time	Auto
	Offset-4 Sweep Time	Auto
	Offset-5 Sweep Time	Auto
	Offset-6 Sweep Time	Auto
	Offset-7 Sweep Time	Auto
	Offset-1 Auto Sweep Time Select	Fast
	Offset-2 Auto Sweep Time Select	Fast
	Offset-3 Auto Sweep Time Select	Fast
	Offset-4 Auto Sweep Time Select	Fast
	Offset-5 Auto Sweep Time Select	Fast
	Offset-6 Auto Sweep Time Select	Fast
	Offset-7 Auto Sweep Time Select	Fast
	Offset-1 Detection	Positive
	Offset-2 Detection	Positive
	Offset-3 Detection	Positive
	Offset-4 Detection	Positive
	Offset-5 Detection	Positive
	Offset-6 Detection	Positive
	Offset-7 Detection	Positive

Table C-5 Standard parameters for Spectrum Emission Mask (Cont'd)

Standard	Parameter Name	Setting
Microlink ETSI CS:14MHz Class:5B Freq Band:17G - 30GHz	Offset-1 Trace Point	1001
	Offset-2 Trace Point	1001
	Offset-3 Trace Point	1001
	Offset-4 Trace Point	1001
	Offset-5 Trace Point	1001
	Offset-6 Trace Point	1001
	Offset-7 Trace Point	1001
	Offset-1 On/Off	On
	Offset-2 On/Off	On
	Offset-3 On/Off	On
	Offset-4 On/Off	On
	Offset-5 On/Off	On
	Offset-6 On/Off	On
	Offset-7 On/Off	On
	Limit-1 REL Start Level	1.0 dB
	Limit-2 REL Start Level	1.0 dB
	Limit-3 REL Start Level	-10.0 dB
	Limit-4 REL Start Level	-32.0 dB
	Limit-5 REL Start Level	-36.0 dB
	Limit-6 REL Start Level	-45.0 dB
	Limit-7 REL Start Level	-50.0 dB
	Limit-1 REL Stop Level	1.0 dB
	Limit-2 REL Stop Level	-10.0 dB
	Limit-3 REL Stop Level	-32.0 dB
	Limit-4 REL Stop Level	-36.0 dB
	Limit-5 REL Stop Level	-45.0 dB
	Limit-6 REL Stop Level	-50.0 dB
	Limit-7 REL Stop Level	-50.0 dB
	Limit-1 Fail Logic	REL
	Limit-2 Fail Logic	REL
	Limit-3 Fail Logic	REL
Limit-4 Fail Logic	REL	
Limit-5 Fail Logic	REL	
Limit-6 Fail Logic	REL	
Limit-7 Fail Logic	REL	

Table C-5 Standard parameters for Spectrum Emission Mask (Cont'd)

Standard	Parameter Name	Setting
Microlink ETSI CS:14MHz Class:5B Freq Band:above 30GHz	Frequency Span	70 MHz
	Limit Side	Both
	Reference Mode	Peak
	Channel BW	1 kHz
	RBW	100 kHz
	VBW	300 Hz
	Sweep Time	Auto
	Auto Sweep Time Select	Fast
	Detection	Positive
	Trace Point	1001
	Filter Type	Root Nyquist
	Roll-off Factor	0.22
	Offset-1 Start Freq	0 Hz
	Offset-2 Start Freq	6 MHz
	Offset-3 Start Freq	7.25 MHz
	Offset-4 Start Freq	7.75 MHz
	Offset-5 Start Freq	8.5 MHz
	Offset-6 Start Freq	20 MHz
	Offset-1 Stop Freq	6 MHz
	Offset-2 Stop Freq	7.25 MHz
	Offset-3 Stop Freq	7.75 MHz
	Offset-4 Stop Freq	8.5 MHz
	Offset-5 Stop Freq	20 MHz
	Offset-6 Stop Freq	35 MHz
	Offset-1 Reference Level	Auto
	Offset-2 Reference Level	Auto
	Offset-3 Reference Level	Auto
	Offset-4 Reference Level	Auto
	Offset-5 Reference Level	Auto
	Offset-6 Reference Level	Auto
	Offset-1 RBW	100 kHz
	Offset-2 RBW	100 kHz
Offset-3 RBW	100 kHz	
Offset-4 RBW	100 kHz	
Offset-5 RBW	100 kHz	
Offset-6 RBW	100 kHz	

Table C-5 Standard parameters for Spectrum Emission Mask (Cont'd)

Standard	Parameter Name	Setting
Microlink ETSI CS:14MHz Class:5B Freq Band:above 30GHz	Offset-1 VBW	300 Hz
	Offset-2 VBW	300 Hz
	Offset-3 VBW	300 Hz
	Offset-4 VBW	300 Hz
	Offset-5 VBW	300 Hz
	Offset-6 VBW	300 Hz
	Offset-1 Sweep Time	Auto
	Offset-2 Sweep Time	Auto
	Offset-3 Sweep Time	Auto
	Offset-4 Sweep Time	Auto
	Offset-5 Sweep Time	Auto
	Offset-6 Sweep Time	Auto
	Offset-1 Auto Sweep Time Select	Fast
	Offset-2 Auto Sweep Time Select	Fast
	Offset-3 Auto Sweep Time Select	Fast
	Offset-4 Auto Sweep Time Select	Fast
	Offset-5 Auto Sweep Time Select	Fast
	Offset-6 Auto Sweep Time Select	Fast
	Offset-1 Detection	Positive
	Offset-2 Detection	Positive
	Offset-3 Detection	Positive
	Offset-4 Detection	Positive
	Offset-5 Detection	Positive
	Offset-6 Detection	Positive
	Offset-1 Trace Point	1001
	Offset-2 Trace Point	1001
	Offset-3 Trace Point	1001
	Offset-4 Trace Point	1001
	Offset-5 Trace Point	1001
	Offset-6 Trace Point	1001
	Offset-2 Sweep Time	Auto
	Offset-3 Sweep Time	Auto
Offset-4 Sweep Time	Auto	
Offset-5 Sweep Time	Auto	

Table C-5 Standard parameters for Spectrum Emission Mask (Cont'd)

Standard	Parameter Name	Setting
Microlink ETSI CS:14MHz Class:5B Freq Band:above 30GHz	Offset-1 On/Off	On
	Offset-2 On/Off	On
	Offset-3 On/Off	On
	Offset-4 On/Off	On
	Offset-5 On/Off	On
	Offset-6 On/Off	On
	Limit-1 REL Start Level	1.0 dB
	Limit-2 REL Start Level	1.0 dB
	Limit-3 REL Start Level	-10.0 dB
	Limit-4 REL Start Level	-32.0 dB
	Limit-5 REL Start Level	-36.0 dB
	Limit-6 REL Start Level	-45.0 dB
	Limit-1 REL Stop Level	1.0 dB
	Limit-2 REL Stop Level	-10.0 dB
	Limit-3 REL Stop Level	-32.0 dB
	Limit-4 REL Stop Level	-36.0 dB
	Limit-5 REL Stop Level	-45.0 dB
	Limit-6 REL Stop Level	-45.0 dB
	Limit-1 Fail Logic	REL
	Limit-2 Fail Logic	REL
	Limit-3 Fail Logic	REL
	Limit-4 Fail Logic	REL
	Limit-5 Fail Logic	REL
	Limit-6 Fail Logic	REL

Microlink ETSI CS: 28MHz

Table C-5 Standard parameters for Spectrum Emission Mask (Cont'd)

Standard	Parameter Name	Setting
Microlink ETSI CS:28MHz Class:2	Frequency Span	140 MHz
	Limit Side	Both
	Reference Mode	Peak
	Channel BW	1 kHz
	RBW	100 kHz
	VBW	300 Hz
	Sweep Time	Auto
	Auto Sweep Time Select	Fast
	Detection	Positive
	Trace Point	1001
	Filter Type	Root Nyquist
	Roll-off Factor	0.22
	Offset-1 Start Freq	0 Hz
	Offset-2 Start Freq	12.8 MHz
	Offset-3 Start Freq	16.4 MHz
	Offset-4 Start Freq	25 MHz
	Offset-5 Start Freq	45 MHz
	Offset-1 Stop Freq	12.8 MHz
	Offset-2 Stop Freq	16.4 MHz
	Offset-3 Stop Freq	25 MHz
	Offset-4 Stop Freq	45 MHz
	Offset-5 Stop Freq	70 MHz
	Offset-1 Reference Level	Auto
	Offset-2 Reference Level	Auto
	Offset-3 Reference Level	Auto
	Offset-4 Reference Level	Auto
	Offset-5 Reference Level	Auto
	Offset-1 RBW	100 kHz
	Offset-2 RBW	100 kHz
	Offset-3 RBW	100 kHz
	Offset-4 RBW	100 kHz
	Offset-5 RBW	100 kHz
Offset-1 VBW	300 Hz	
Offset-2 VBW	300 Hz	
Offset-3 VBW	300 Hz	
Offset-4 VBW	300 Hz	
Offset-5 VBW	300 Hz	

Table C-5 Standard parameters for Spectrum Emission Mask (Cont'd)

Standard	Parameter Name	Setting
Microlink ETSI CS:28MHz Class:2	Offset-1 Sweep Time	Auto
	Offset-2 Sweep Time	Auto
	Offset-3 Sweep Time	Auto
	Offset-4 Sweep Time	Auto
	Offset-5 Sweep Time	Auto
	Offset-1 Auto Sweep Time Select	Fast
	Offset-2 Auto Sweep Time Select	Fast
	Offset-3 Auto Sweep Time Select	Fast
	Offset-4 Auto Sweep Time Select	Fast
	Offset-5 Auto Sweep Time Select	Fast
	Offset-1 Detection	Positive
	Offset-2 Detection	Positive
	Offset-3 Detection	Positive
	Offset-4 Detection	Positive
	Offset-5 Detection	Positive
	Offset-1 Trace Point	1001
	Offset-2 Trace Point	1001
	Offset-3 Trace Point	1001
	Offset-4 Trace Point	1001
	Offset-5 Trace Point	1001

Table C-5 Standard parameters for Spectrum Emission Mask (Cont'd)

Standard	Parameter Name	Setting
Microlink ETSI CS:28MHz Class:2	Offset-1 On/Off	On
	Offset-2 On/Off	On
	Offset-3 On/Off	On
	Offset-4 On/Off	On
	Offset-5 On/Off	On
	Limit-1 REL Start Level	2.0 dB
	Limit-2 REL Start Level	2.0 dB
	Limit-3 REL Start Level	-23.0 dB
	Limit-4 REL Start Level	-23.0 dB
	Limit-5 REL Start Level	-45.0 dB
	Limit-1 REL Stop Level	2.0 dB
	Limit-2 REL Stop Level	-23.0 dB
	Limit-3 REL Stop Level	-23.0 dB
	Limit-4 REL Stop Level	-45.0 dB
	Limit-5 REL Stop Level	-45.0 dB
	Limit-1 Fail Logic	REL
	Limit-2 Fail Logic	REL
	Limit-3 Fail Logic	REL
	Limit-4 Fail Logic	REL
	Limit-5 Fail Logic	REL

Table C-5 Standard parameters for Spectrum Emission Mask (Cont'd)

Standard	Parameter Name	Setting
Microlink ETSI CS:28MHz Class:4L Freq Band:3G - 17GHz	Frequency Span	140 MHz
	Limit Side	Both
	Reference Mode	Peak
	Channel BW	1 kHz
	RBW	100 kHz
	VBW	300 Hz
	Sweep Time	Auto
	Auto Sweep Time Select	Fast
	Detection	Positive
	Trace Point	1001
	Filter Type	Root Nyquist
	Roll-off Factor	0.22
	Offset-1 Start Freq	0 Hz
	Offset-2 Start Freq	12.8 MHz
	Offset-3 Start Freq	17 MHz
	Offset-4 Start Freq	56 MHz
	Offset-1 Stop Freq	12.8 MHz
	Offset-2 Stop Freq	17 MHz
	Offset-3 Stop Freq	56 MHz
	Offset-4 Stop Freq	70 MHz
	Offset-1 Reference Level	Auto
	Offset-2 Reference Level	Auto
	Offset-3 Reference Level	Auto
	Offset-4 Reference Level	Auto
	Offset-1 RBW	100 kHz
	Offset-2 RBW	100 kHz
	Offset-3 RBW	100 kHz
	Offset-4 RBW	100 kHz
	Offset-1 VBW	300 Hz
	Offset-2 VBW	300 Hz
	Offset-3 VBW	300 Hz
	Offset-4 VBW	300 Hz
Offset-1 Sweep Time	Auto	
Offset-2 Sweep Time	Auto	
Offset-3 Sweep Time	Auto	
Offset-4 Sweep Time	Auto	

Table C-5 Standard parameters for Spectrum Emission Mask (Cont'd)

Standard	Parameter Name	Setting
Microlink ETSI CS:28MHz Class:4L Freq Band:3G - 17GHz	Offset-1 Auto Sweep Time Select	Fast
	Offset-2 Auto Sweep Time Select	Fast
	Offset-3 Auto Sweep Time Select	Fast
	Offset-4 Auto Sweep Time Select	Fast
	Offset-1 Detection	Positive
	Offset-2 Detection	Positive
	Offset-3 Detection	Positive
	Offset-4 Detection	Positive
	Offset-1 Trace Point	1001
	Offset-2 Trace Point	1001
	Offset-3 Trace Point	1001
	Offset-4 Trace Point	1001
	Offset-1 On/Off	On
	Offset-2 On/Off	On
	Offset-3 On/Off	On
	Offset-4 On/Off	On
	Limit-1 REL Start Level	2.0 dB
	Limit-2 REL Start Level	2.0 dB
	Limit-3 REL Start Level	-27.0 dB
	Limit-4 REL Start Level	-55.0 dB
	Limit-1 REL Stop Level	2.0 dB
	Limit-2 REL Stop Level	-27.0 dB
	Limit-3 REL Stop Level	-55.0 dB
	Limit-4 REL Stop Level	-55.0 dB
	Limit-1 Fail Logic	REL
	Limit-2 Fail Logic	REL
	Limit-3 Fail Logic	REL
	Limit-4 Fail Logic	REL

Table C-5 Standard parameters for Spectrum Emission Mask (Cont'd)

Standard	Parameter Name	Setting
Microlink ETSI CS:28MHz Class:4L Freq Band:17G - 30GHz	Frequency Span	140 MHz
	Limit Side	Both
	Reference Mode	Peak
	Channel BW	1 kHz
	RBW	100 kHz
	VBW	300 Hz
	Sweep Time	Auto
	Auto Sweep Time Select	Fast
	Detection	Positive
	Trace Point	1001
	Filter Type	Root Nyquist
	Roll-off Factor	0.22
	Offset-1 Start Freq	0 Hz
	Offset-2 Start Freq	12.8 MHz
	Offset-3 Start Freq	17 MHz
	Offset-4 Start Freq	49 MHz
	Offset-1 Stop Freq	12.8 MHz
	Offset-2 Stop Freq	17 MHz
	Offset-3 Stop Freq	49 MHz
	Offset-4 Stop Freq	70 MHz
	Offset-1 Reference Level	Auto
	Offset-2 Reference Level	Auto
	Offset-3 Reference Level	Auto
	Offset-4 Reference Level	Auto
	Offset-1 RBW	100 kHz
	Offset-2 RBW	100 kHz
	Offset-3 RBW	100 kHz
	Offset-4 RBW	100 kHz
	Offset-1 VBW	300 Hz
	Offset-2 VBW	300 Hz
	Offset-3 VBW	300 Hz
	Offset-4 VBW	300 Hz
Offset-1 Sweep Time	Auto	
Offset-2 Sweep Time	Auto	
Offset-3 Sweep Time	Auto	
Offset-4 Sweep Time	Auto	

Table C-5 Standard parameters for Spectrum Emission Mask (Cont'd)

Standard	Parameter Name	Setting
Microlink ETSI CS:28MHz Class:4L Freq Band:17G - 30GHz	Offset-1 Auto Sweep Time Select	Fast
	Offset-2 Auto Sweep Time Select	Fast
	Offset-3 Auto Sweep Time Select	Fast
	Offset-4 Auto Sweep Time Select	Fast
	Offset-1 Detection	Positive
	Offset-2 Detection	Positive
	Offset-3 Detection	Positive
	Offset-4 Detection	Positive
	Offset-1 Trace Point	1001
	Offset-2 Trace Point	1001
	Offset-3 Trace Point	1001
	Offset-4 Trace Point	1001
	Offset-1 On/Off	On
	Offset-2 On/Off	On
	Offset-3 On/Off	On
	Offset-4 On/Off	On
	Limit-1 REL Start Level	2.0 dB
	Limit-2 REL Start Level	2.0 dB
	Limit-3 REL Start Level	-27.0 dB
	Limit-4 REL Start Level	-50.0 dB
	Limit-1 REL Stop Level	2.0 dB
	Limit-2 REL Stop Level	-27.0 dB
	Limit-3 REL Stop Level	-50.0 dB
	Limit-4 REL Stop Level	-50.0 dB
	Limit-1 Fail Logic	REL
	Limit-2 Fail Logic	REL
	Limit-3 Fail Logic	REL
	Limit-4 Fail Logic	REL

Table C-5 Standard parameters for Spectrum Emission Mask (Cont'd)

Standard	Parameter Name	Setting
Microlink ETSI CS:28MHz Class:4L Freq Band:above 30GHz	Frequency Span	140 MHz
	Limit Side	Both
	Reference Mode	Peak
	Channel BW	1 kHz
	RBW	100 kHz
	VBW	300 Hz
	Sweep Time	Auto
	Auto Sweep Time Select	Fast
	Detection	Positive
	Trace Point	1001
	Filter Type	Root Nyquist
	Roll-off Factor	0.22
	Offset-1 Start Freq	0 Hz
	Offset-2 Start Freq	12.8 MHz
	Offset-3 Start Freq	17 MHz
	Offset-4 Start Freq	42 MHz
	Offset-1 Stop Freq	12.8 MHz
	Offset-2 Stop Freq	17 MHz
	Offset-3 Stop Freq	42 MHz
	Offset-4 Stop Freq	70 MHz
	Offset-1 Reference Level	Auto
	Offset-2 Reference Level	Auto
	Offset-3 Reference Level	Auto
	Offset-4 Reference Level	Auto
	Offset-1 RBW	100 kHz
	Offset-2 RBW	100 kHz
	Offset-3 RBW	100 kHz
	Offset-4 RBW	100 kHz
	Offset-1 VBW	300 Hz
	Offset-2 VBW	300 Hz
	Offset-3 VBW	300 Hz
	Offset-4 VBW	300 Hz
Offset-1 Sweep Time	Auto	
Offset-2 Sweep Time	Auto	
Offset-3 Sweep Time	Auto	
Offset-4 Sweep Time	Auto	

Table C-5 Standard parameters for Spectrum Emission Mask (Cont'd)

Standard	Parameter Name	Setting
Microlink ETSI CS:28MHz Class:4L Freq Band:above 30GHz	Offset-1 Auto Sweep Time Select	Fast
	Offset-2 Auto Sweep Time Select	Fast
	Offset-3 Auto Sweep Time Select	Fast
	Offset-4 Auto Sweep Time Select	Fast
	Offset-1 Detection	Positive
	Offset-2 Detection	Positive
	Offset-3 Detection	Positive
	Offset-4 Detection	Positive
	Offset-1 Trace Point	1001
	Offset-2 Trace Point	1001
	Offset-3 Trace Point	1001
	Offset-4 Trace Point	1001
	Offset-1 On/Off	On
	Offset-2 On/Off	On
	Offset-3 On/Off	On
	Offset-4 On/Off	On
	Limit-1 REL Start Level	2.0 dB
	Limit-2 REL Start Level	2.0 dB
	Limit-3 REL Start Level	-27.0 dB
	Limit-4 REL Start Level	-45.0 dB
	Limit-1 REL Stop Level	2.0 dB
	Limit-2 REL Stop Level	-27.0 dB
	Limit-3 REL Stop Level	-45.0 dB
	Limit-4 REL Stop Level	-45.0 dB
	Limit-1 Fail Logic	REL
	Limit-2 Fail Logic	REL
	Limit-3 Fail Logic	REL
	Limit-4 Fail Logic	REL

Table C-5 Standard parameters for Spectrum Emission Mask (Cont'd)

Standard	Parameter Name	Setting
Microlink ETSI CS:28MHz Class:4H Freq Band:3G - 17GHz	Frequency Span	140 MHz
	Limit Side	Both
	Reference Mode	Peak
	Channel BW	1 kHz
	RBW	100 kHz
	VBW	300 Hz
	Sweep Time	Auto
	Auto Sweep Time Select	Fast
	Detection	Positive
	Trace Point	1001
	Filter Type	Root Nyquist
	Roll-off Factor	0.22
	Offset-1 Start Freq	0 Hz
	Offset-2 Start Freq	12 MHz
	Offset-3 Start Freq	15 MHz
	Offset-4 Start Freq	16.8 MHz
	Offset-5 Start Freq	35 MHz
	Offset-6 Start Freq	55 MHz
	Offset-1 Stop Freq	12 MHz
	Offset-2 Stop Freq	15 MHz
	Offset-3 Stop Freq	16.8 MHz
	Offset-4 Stop Freq	35 MHz
	Offset-5 Stop Freq	55 MHz
	Offset-6 Stop Freq	70 MHz
	Offset-1 Reference Level	Auto
	Offset-2 Reference Level	Auto
	Offset-3 Reference Level	Auto
	Offset-4 Reference Level	Auto
	Offset-5 Reference Level	Auto
	Offset-6 Reference Level	Auto
	Offset-1 RBW	100 kHz
	Offset-2 RBW	100 kHz
Offset-3 RBW	100 kHz	
Offset-4 RBW	100 kHz	
Offset-5 RBW	100 kHz	
Offset-6 RBW	100 kHz	

Table C-5 Standard parameters for Spectrum Emission Mask (Cont'd)

Standard	Parameter Name	Setting
Microlink ETSI CS:28MHz Class:4H Freq Band:3G - 17GHz	Offset-1 VBW	300 Hz
	Offset-2 VBW	300 Hz
	Offset-3 VBW	300 Hz
	Offset-4 VBW	300 Hz
	Offset-5 VBW	300 Hz
	Offset-6 VBW	300 Hz
	Offset-1 Sweep Time	Auto
	Offset-2 Sweep Time	Auto
	Offset-3 Sweep Time	Auto
	Offset-4 Sweep Time	Auto
	Offset-5 Sweep Time	Auto
	Offset-6 Sweep Time	Auto
	Offset-1 Auto Sweep Time Select	Fast
	Offset-2 Auto Sweep Time Select	Fast
	Offset-3 Auto Sweep Time Select	Fast
	Offset-4 Auto Sweep Time Select	Fast
	Offset-5 Auto Sweep Time Select	Fast
	Offset-6 Auto Sweep Time Select	Fast
	Offset-1 Detection	Positive
	Offset-2 Detection	Positive
	Offset-3 Detection	Positive
	Offset-4 Detection	Positive
	Offset-5 Detection	Positive
	Offset-6 Detection	Positive
	Offset-1 Trace Point	1001
	Offset-2 Trace Point	1001
	Offset-3 Trace Point	1001
	Offset-4 Trace Point	1001
Offset-5 Trace Point	1001	
Offset-6 Trace Point	1001	

Table C-5 Standard parameters for Spectrum Emission Mask (Cont'd)

Standard	Parameter Name	Setting
Microlink ETSI CS:28MHz Class:4H Freq Band:3G - 17GHz	Offset-1 On/Off	On
	Offset-2 On/Off	On
	Offset-3 On/Off	On
	Offset-4 On/Off	On
	Offset-5 On/Off	On
	Offset-6 On/Off	On
	Limit-1 REL Start Level	2.0 dB
	Limit-2 REL Start Level	2.0 dB
	Limit-3 REL Start Level	-10.0 dB
	Limit-4 REL Start Level	-33.0 dB
	Limit-5 REL Start Level	-40.0 dB
	Limit-6 REL Start Level	-55.0 dB
	Limit-1 REL Stop Level	2.0 dB
	Limit-2 REL Stop Level	-10.0 dB
	Limit-3 REL Stop Level	-33.0 dB
	Limit-4 REL Stop Level	-40.0 dB
	Limit-5 REL Stop Level	-55.0 dB
	Limit-6 REL Stop Level	-55.0 dB
	Limit-1 Fail Logic	REL
	Limit-2 Fail Logic	REL
	Limit-3 Fail Logic	REL
	Limit-4 Fail Logic	REL
	Limit-5 Fail Logic	REL
	Limit-6 Fail Logic	REL

Table C-5 Standard parameters for Spectrum Emission Mask (Cont'd)

Standard	Parameter Name	Setting
Microlink ETSI CS:28MHz Class:4H Freq Band:17G - 30GHz	Frequency Span	140 MHz
	Limit Side	Both
	Reference Mode	Peak
	Channel BW	1 kHz
	RBW	100 kHz
	VBW	300 Hz
	Sweep Time	Auto
	Auto Sweep Time Select	Fast
	Detection	Positive
	Trace Point	1001
	Filter Type	Root Nyquist
	Roll-off Factor	0.22
	Offset-1 Start Freq	0 Hz
	Offset-2 Start Freq	12 MHz
	Offset-3 Start Freq	15 MHz
	Offset-4 Start Freq	16.8 MHz
	Offset-5 Start Freq	35 MHz
	Offset-6 Start Freq	48.3 MHz
	Offset-1 Stop Freq	12 MHz
	Offset-2 Stop Freq	15 MHz
	Offset-3 Stop Freq	16.8 MHz
	Offset-4 Stop Freq	35 MHz
	Offset-5 Stop Freq	48.3 MHz
	Offset-6 Stop Freq	70 MHz
	Offset-1 Reference Level	Auto
	Offset-2 Reference Level	Auto
	Offset-3 Reference Level	Auto
	Offset-4 Reference Level	Auto
	Offset-5 Reference Level	Auto
	Offset-6 Reference Level	Auto
Offset-1 RBW	100 kHz	
Offset-2 RBW	100 kHz	
Offset-3 RBW	100 kHz	
Offset-4 RBW	100 kHz	
Offset-5 RBW	100 kHz	
Offset-6 RBW	100 kHz	

Table C-5 Standard parameters for Spectrum Emission Mask (Cont'd)

Standard	Parameter Name	Setting
Microlink ETSI CS:28MHz Class:4H Freq Band:17G - 30GHz	Offset-1 VBW	300 Hz
	Offset-2 VBW	300 Hz
	Offset-3 VBW	300 Hz
	Offset-4 VBW	300 Hz
	Offset-5 VBW	300 Hz
	Offset-6 VBW	300 Hz
	Offset-1 Sweep Time	Auto
	Offset-2 Sweep Time	Auto
	Offset-3 Sweep Time	Auto
	Offset-4 Sweep Time	Auto
	Offset-5 Sweep Time	Auto
	Offset-6 Sweep Time	Auto
	Offset-1 Auto Sweep Time Select	Fast
	Offset-2 Auto Sweep Time Select	Fast
	Offset-3 Auto Sweep Time Select	Fast
	Offset-4 Auto Sweep Time Select	Fast
	Offset-5 Auto Sweep Time Select	Fast
	Offset-6 Auto Sweep Time Select	Fast
	Offset-1 Detection	Positive
	Offset-2 Detection	Positive
	Offset-3 Detection	Positive
	Offset-4 Detection	Positive
	Offset-5 Detection	Positive
	Offset-6 Detection	Positive
	Offset-1 Trace Point	1001
	Offset-2 Trace Point	1001
	Offset-3 Trace Point	1001
	Offset-4 Trace Point	1001
Offset-5 Trace Point	1001	
Offset-6 Trace Point	1001	

Table C-5 Standard parameters for Spectrum Emission Mask (Cont'd)

Standard	Parameter Name	Setting
Microlink ETSI CS:28MHz Class:4H Freq Band:17G - 30GHz	Offset-1 On/Off	On
	Offset-2 On/Off	On
	Offset-3 On/Off	On
	Offset-4 On/Off	On
	Offset-5 On/Off	On
	Offset-6 On/Off	On
	Limit-1 REL Start Level	2.0 dB
	Limit-2 REL Start Level	2.0 dB
	Limit-3 REL Start Level	-10.0 dB
	Limit-4 REL Start Level	-33.0 dB
	Limit-5 REL Start Level	-40.0 dB
	Limit-6 REL Start Level	-50.0 dB
	Limit-1 REL Stop Level	2.0 dB
	Limit-2 REL Stop Level	-10.0 dB
	Limit-3 REL Stop Level	-33.0 dB
	Limit-4 REL Stop Level	-40.0 dB
	Limit-5 REL Stop Level	-50.0 dB
	Limit-6 REL Stop Level	-50.0 dB
	Limit-1 Fail Logic	REL
	Limit-2 Fail Logic	REL
	Limit-3 Fail Logic	REL
	Limit-4 Fail Logic	REL
	Limit-5 Fail Logic	REL
	Limit-6 Fail Logic	REL

Table C-5 Standard parameters for Spectrum Emission Mask (Cont'd)

Standard	Parameter Name	Setting
Microlink ETSI CS:28MHz Class:4H Freq Band:above 30GHz	Frequency Span	140 MHz
	Limit Side	Both
	Reference Mode	Peak
	Channel BW	1 kHz
	RBW	100 kHz
	VBW	300 Hz
	Sweep Time	Auto
	Auto Sweep Time Select	Fast
	Detection	Positive
	Trace Point	1001
	Filter Type	Root Nyquist
	Roll-off Factor	0.22
	Offset-1 Start Freq	0 Hz
	Offset-2 Start Freq	12 MHz
	Offset-3 Start Freq	15 MHz
	Offset-4 Start Freq	16.8 MHz
	Offset-5 Start Freq	35 MHz
	Offset-6 Start Freq	41.7 MHz
	Offset-1 Stop Freq	12 MHz
	Offset-2 Stop Freq	15 MHz
	Offset-3 Stop Freq	16.8 MHz
	Offset-4 Stop Freq	35 MHz
	Offset-5 Stop Freq	41.7 MHz
	Offset-6 Stop Freq	70 MHz
	Offset-1 Reference Level	Auto
	Offset-2 Reference Level	Auto
	Offset-3 Reference Level	Auto
	Offset-4 Reference Level	Auto
	Offset-5 Reference Level	Auto
	Offset-6 Reference Level	Auto
Offset-1 RBW	100 kHz	
Offset-2 RBW	100 kHz	
Offset-3 RBW	100 kHz	
Offset-4 RBW	100 kHz	
Offset-5 RBW	100 kHz	
Offset-6 RBW	100 kHz	

Table C-5 Standard parameters for Spectrum Emission Mask (Cont'd)

Standard	Parameter Name	Setting
Microlink ETSI CS:28MHz Class:4H Freq Band:above 30GHz	Offset-1 VBW	300 Hz
	Offset-2 VBW	300 Hz
	Offset-3 VBW	300 Hz
	Offset-4 VBW	300 Hz
	Offset-5 VBW	300 Hz
	Offset-6 VBW	300 Hz
	Offset-1 Sweep Time	Auto
	Offset-2 Sweep Time	Auto
	Offset-3 Sweep Time	Auto
	Offset-4 Sweep Time	Auto
	Offset-5 Sweep Time	Auto
	Offset-6 Sweep Time	Auto
	Offset-1 Auto Sweep Time Select	Fast
	Offset-2 Auto Sweep Time Select	Fast
	Offset-3 Auto Sweep Time Select	Fast
	Offset-4 Auto Sweep Time Select	Fast
	Offset-5 Auto Sweep Time Select	Fast
	Offset-6 Auto Sweep Time Select	Fast
	Offset-1 Detection	Positive
	Offset-2 Detection	Positive
	Offset-3 Detection	Positive
	Offset-4 Detection	Positive
	Offset-5 Detection	Positive
	Offset-6 Detection	Positive
	Offset-1 Trace Point	1001
	Offset-2 Trace Point	1001
	Offset-3 Trace Point	1001
	Offset-4 Trace Point	1001
Offset-5 Trace Point	1001	
Offset-6 Trace Point	1001	

Table C-5 Standard parameters for Spectrum Emission Mask (Cont'd)

Standard	Parameter Name	Setting
Microlink ETSI CS:28MHz Class:4H Freq Band:above 30GHz	Offset-1 On/Off	On
	Offset-2 On/Off	On
	Offset-3 On/Off	On
	Offset-4 On/Off	On
	Offset-5 On/Off	On
	Offset-6 On/Off	On
	Limit-1 REL Start Level	2.0 dB
	Limit-2 REL Start Level	2.0 dB
	Limit-3 REL Start Level	-10.0 dB
	Limit-4 REL Start Level	-33.0 dB
	Limit-5 REL Start Level	-40.0 dB
	Limit-6 REL Start Level	-45.0 dB
	Limit-1 REL Stop Level	2.0 dB
	Limit-2 REL Stop Level	-10.0 dB
	Limit-3 REL Stop Level	-33.0 dB
	Limit-4 REL Stop Level	-40.0 dB
	Limit-5 REL Stop Level	-45.0 dB
	Limit-6 REL Stop Level	-45.0 dB
	Limit-1 Fail Logic	REL
	Limit-2 Fail Logic	REL
	Limit-3 Fail Logic	REL
	Limit-4 Fail Logic	REL
	Limit-5 Fail Logic	REL
	Limit-6 Fail Logic	REL

Table C-5 Standard parameters for Spectrum Emission Mask (Cont'd)

Standard	Parameter Name	Setting
Microlink ETSI CS:28MHz Class:5A - 6A Freq Band:3G - 17GHz	Frequency Span	140 MHz
	Limit Side	Both
	Reference Mode	Peak
	Channel BW	1 kHz
	RBW	100 kHz
	VBW	300 Hz
	Sweep Time	Auto
	Auto Sweep Time Select	Fast
	Detection	Positive
	Trace Point	1001
	Filter Type	Root Nyquist
	Roll-off Factor	0.22
	Offset-1 Start Freq	0 Hz
	Offset-2 Start Freq	12.5 MHz
	Offset-3 Start Freq	15 MHz
	Offset-4 Start Freq	17 MHz
	Offset-5 Start Freq	20 MHz
	Offset-6 Start Freq	40 MHz
	Offset-7 Start Freq	54 MHz
	Offset-1 Stop Freq	12.5 MHz
	Offset-2 Stop Freq	15 MHz
	Offset-3 Stop Freq	17 MHz
	Offset-4 Stop Freq	20 MHz
	Offset-5 Stop Freq	40 MHz
	Offset-6 Stop Freq	54 MHz
	Offset-7 Stop Freq	70 MHz
	Offset-1 Reference Level	Auto
	Offset-2 Reference Level	Auto
	Offset-3 Reference Level	Auto
	Offset-4 Reference Level	Auto
	Offset-5 Reference Level	Auto
	Offset-6 Reference Level	Auto
	Offset-7 Reference Level	Auto
Offset-1 RBW	100 kHz	
Offset-2 RBW	100 kHz	
Offset-3 RBW	100 kHz	
Offset-4 RBW	100 kHz	
Offset-5 RBW	100 kHz	
Offset-6 RBW	100 kHz	
Offset-7 RBW	100 kHz	

Table C-5 Standard parameters for Spectrum Emission Mask (Cont'd)

Standard	Parameter Name	Setting
Microlink ETSI CS:28MHz Class:5A - 6A Freq Band:3G - 17GHz	Offset-1 VBW	300 Hz
	Offset-2 VBW	300 Hz
	Offset-3 VBW	300 Hz
	Offset-4 VBW	300 Hz
	Offset-5 VBW	300 Hz
	Offset-6 VBW	300 Hz
	Offset-7 VBW	300 Hz
	Offset-1 Sweep Time	Auto
	Offset-2 Sweep Time	Auto
	Offset-3 Sweep Time	Auto
	Offset-4 Sweep Time	Auto
	Offset-5 Sweep Time	Auto
	Offset-6 Sweep Time	Auto
	Offset-7 Sweep Time	Auto
	Offset-1 Auto Sweep Time Select	Fast
	Offset-2 Auto Sweep Time Select	Fast
	Offset-3 Auto Sweep Time Select	Fast
	Offset-4 Auto Sweep Time Select	Fast
	Offset-5 Auto Sweep Time Select	Fast
	Offset-6 Auto Sweep Time Select	Fast
	Offset-7 Auto Sweep Time Select	Fast
	Offset-1 Detection	Positive
	Offset-2 Detection	Positive
	Offset-3 Detection	Positive
	Offset-4 Detection	Positive
	Offset-5 Detection	Positive
	Offset-6 Detection	Positive
	Offset-7 Detection	Positive

Table C-5 Standard parameters for Spectrum Emission Mask (Cont'd)

Standard	Parameter Name	Setting
Microlink ETSI CS:28MHz Class:5A - 6A Freq Band:3G - 17GHz	Offset-1 Trace Point	1001
	Offset-2 Trace Point	1001
	Offset-3 Trace Point	1001
	Offset-4 Trace Point	1001
	Offset-5 Trace Point	1001
	Offset-6 Trace Point	1001
	Offset-7 Trace Point	1001
	Offset-1 On/Off	On
	Offset-2 On/Off	On
	Offset-3 On/Off	On
	Offset-4 On/Off	On
	Offset-5 On/Off	On
	Offset-6 On/Off	On
	Offset-7 On/Off	On
	Limit-1 REL Start Level	2.0 dB
	Limit-2 REL Start Level	2.0 dB
	Limit-3 REL Start Level	-10.0 dB
	Limit-4 REL Start Level	-32.0 dB
	Limit-5 REL Start Level	-35.0 dB
	Limit-6 REL Start Level	-45.0 dB
	Limit-7 REL Start Level	-55.0 dB
	Limit-1 REL Stop Level	2.0 dB
	Limit-2 REL Stop Level	-10.0 dB
	Limit-3 REL Stop Level	-32.0 dB
	Limit-4 REL Stop Level	-35.0 dB
	Limit-5 REL Stop Level	-45.0 dB
	Limit-6 REL Stop Level	-55.0 dB
	Limit-7 REL Stop Level	-55.0 dB
	Limit-1 Fail Logic	REL
	Limit-2 Fail Logic	REL
	Limit-3 Fail Logic	REL
Limit-4 Fail Logic	REL	
Limit-5 Fail Logic	REL	
Limit-6 Fail Logic	REL	
Limit-7 Fail Logic	REL	

Table C-5 Standard parameters for Spectrum Emission Mask (Cont'd)

Standard	Parameter Name	Setting
Microlink ETSI CS: 28MHz Class:5A - 6A Freq Band:17G - 30GHz	Frequency Span	140 MHz
	Limit Side	Both
	Reference Mode	Peak
	Channel BW	1 kHz
	RBW	100 kHz
	VBW	300 Hz
	Sweep Time	Auto
	Auto Sweep Time Select	Fast
	Detection	Positive
	Trace Point	1001
	Filter Type	Root Nyquist
	Roll-off Factor	0.22
	Offset-1 Start Freq	0 Hz
	Offset-2 Start Freq	12.5 MHz
	Offset-3 Start Freq	15 MHz
	Offset-4 Start Freq	17 MHz
	Offset-5 Start Freq	20 MHz
	Offset-6 Start Freq	40 MHz
	Offset-7 Start Freq	47 MHz
	Offset-1 Stop Freq	12.5 MHz
	Offset-2 Stop Freq	15 MHz
	Offset-3 Stop Freq	17 MHz
	Offset-4 Stop Freq	20 MHz
	Offset-5 Stop Freq	40 MHz
	Offset-6 Stop Freq	47 MHz
	Offset-7 Stop Freq	70 MHz
	Offset-1 Reference Level	Auto
	Offset-2 Reference Level	Auto
	Offset-3 Reference Level	Auto
	Offset-4 Reference Level	Auto
	Offset-5 Reference Level	Auto
	Offset-6 Reference Level	Auto
Offset-7 Reference Level	Auto	
Offset-1 RBW	100 kHz	
Offset-2 RBW	100 kHz	
Offset-3 RBW	100 kHz	
Offset-4 RBW	100 kHz	
Offset-5 RBW	100 kHz	
Offset-6 RBW	100 kHz	
Offset-7 RBW	100 kHz	

Table C-5 Standard parameters for Spectrum Emission Mask (Cont'd)

Standard	Parameter Name	Setting
Microlink ETSI CS: 28MHz Class:5A - 6A Freq Band:17G - 30GHz	Offset-1 VBW	300 Hz
	Offset-2 VBW	300 Hz
	Offset-3 VBW	300 Hz
	Offset-4 VBW	300 Hz
	Offset-5 VBW	300 Hz
	Offset-6 VBW	300 Hz
	Offset-7 VBW	300 Hz
	Offset-1 Sweep Time	Auto
	Offset-2 Sweep Time	Auto
	Offset-3 Sweep Time	Auto
	Offset-4 Sweep Time	Auto
	Offset-5 Sweep Time	Auto
	Offset-6 Sweep Time	Auto
	Offset-7 Sweep Time	Auto
	Offset-1 Auto Sweep Time Select	Fast
	Offset-2 Auto Sweep Time Select	Fast
	Offset-3 Auto Sweep Time Select	Fast
	Offset-4 Auto Sweep Time Select	Fast
	Offset-5 Auto Sweep Time Select	Fast
	Offset-6 Auto Sweep Time Select	Fast
	Offset-7 Auto Sweep Time Select	Fast
	Offset-1 Detection	Positive
	Offset-2 Detection	Positive
	Offset-3 Detection	Positive
	Offset-4 Detection	Positive
	Offset-5 Detection	Positive
	Offset-6 Detection	Positive
	Offset-7 Detection	Positive

Table C-5 Standard parameters for Spectrum Emission Mask (Cont'd)

Standard	Parameter Name	Setting
Microlink ETSI CS: 28MHz Class:5A - 6A Freq Band:17G - 30GHz	Offset-1 Trace Point	1001
	Offset-2 Trace Point	1001
	Offset-3 Trace Point	1001
	Offset-4 Trace Point	1001
	Offset-5 Trace Point	1001
	Offset-6 Trace Point	1001
	Offset-7 Trace Point	1001
	Offset-1 On/Off	On
	Offset-2 On/Off	On
	Offset-3 On/Off	On
	Offset-4 On/Off	On
	Offset-5 On/Off	On
	Offset-6 On/Off	On
	Offset-7 On/Off	On
	Limit-1 REL Start Level	2.0 dB
	Limit-2 REL Start Level	2.0 dB
	Limit-3 REL Start Level	-10.0 dB
	Limit-4 REL Start Level	-32.0 dB
	Limit-5 REL Start Level	-35.0 dB
	Limit-6 REL Start Level	-45.0 dB
	Limit-7 REL Start Level	-50.0 dB
	Limit-1 REL Stop Level	2.0 dB
	Limit-2 REL Stop Level	-10.0 dB
	Limit-3 REL Stop Level	-32.0 dB
	Limit-4 REL Stop Level	-35.0 dB
	Limit-5 REL Stop Level	-45.0 dB
	Limit-6 REL Stop Level	-50.0 dB
	Limit-7 REL Stop Level	-50.0 dB
	Limit-1 Fail Logic	REL
	Limit-2 Fail Logic	REL
	Limit-3 Fail Logic	REL
Limit-4 Fail Logic	REL	
Limit-5 Fail Logic	REL	
Limit-6 Fail Logic	REL	
Limit-7 Fail Logic	REL	

Table C-5 Standard parameters for Spectrum Emission Mask (Cont'd)

Standard	Parameter Name	Setting
Microlink ETSI CS:28MHz Class:5A - 6A Freq Band:above 30GHz	Frequency Span	140 MHz
	Limit Side	Both
	Reference Mode	Peak
	Channel BW	1 kHz
	RBW	100 kHz
	VBW	300 Hz
	Sweep Time	Auto
	Auto Sweep Time Select	Fast
	Detection	Positive
	Trace Point	1001
	Filter Type	Root Nyquist
	Roll-off Factor	0.22
	Offset-1 Start Freq	0 Hz
	Offset-2 Start Freq	12.5 MHz
	Offset-3 Start Freq	15 MHz
	Offset-4 Start Freq	17 MHz
	Offset-5 Start Freq	20 MHz
	Offset-6 Start Freq	40 MHz
	Offset-1 Stop Freq	12.5 MHz
	Offset-2 Stop Freq	15 MHz
	Offset-3 Stop Freq	17 MHz
	Offset-4 Stop Freq	20 MHz
	Offset-5 Stop Freq	40 MHz
	Offset-6 Stop Freq	70 MHz
	Offset-1 Reference Level	Auto
	Offset-2 Reference Level	Auto
	Offset-3 Reference Level	Auto
	Offset-4 Reference Level	Auto
	Offset-5 Reference Level	Auto
	Offset-6 Reference Level	Auto
	Offset-1 RBW	100 kHz
	Offset-2 RBW	100 kHz
Offset-3 RBW	100 kHz	
Offset-4 RBW	100 kHz	
Offset-5 RBW	100 kHz	
Offset-6 RBW	100 kHz	

Table C-5 Standard parameters for Spectrum Emission Mask (Cont'd)

Standard	Parameter Name	Setting
Microlink ETSI CS:28MHz Class:5A - 6A Freq Band:above 30GHz	Offset-1 VBW	300 Hz
	Offset-2 VBW	300 Hz
	Offset-3 VBW	300 Hz
	Offset-4 VBW	300 Hz
	Offset-5 VBW	300 Hz
	Offset-6 VBW	300 Hz
	Offset-1 Sweep Time	Auto
	Offset-2 Sweep Time	Auto
	Offset-3 Sweep Time	Auto
	Offset-4 Sweep Time	Auto
	Offset-5 Sweep Time	Auto
	Offset-6 Sweep Time	Auto
	Offset-1 Auto Sweep Time Select	Fast
	Offset-2 Auto Sweep Time Select	Fast
	Offset-3 Auto Sweep Time Select	Fast
	Offset-4 Auto Sweep Time Select	Fast
	Offset-5 Auto Sweep Time Select	Fast
	Offset-6 Auto Sweep Time Select	Fast
	Offset-1 Detection	Positive
	Offset-2 Detection	Positive
	Offset-3 Detection	Positive
	Offset-4 Detection	Positive
	Offset-5 Detection	Positive
	Offset-6 Detection	Positive
	Offset-1 Trace Point	1001
	Offset-2 Trace Point	1001
	Offset-3 Trace Point	1001
	Offset-4 Trace Point	1001
	Offset-5 Trace Point	1001
	Offset-6 Trace Point	1001
	Offset-2 Sweep Time	Auto
	Offset-3 Sweep Time	Auto
Offset-4 Sweep Time	Auto	
Offset-5 Sweep Time	Auto	

Table C-5 Standard parameters for Spectrum Emission Mask (Cont'd)

Standard	Parameter Name	Setting
Microlink ETSI CS:28MHz Class:5A - 6A Freq Band:above 30GHz	Offset-1 On/Off	On
	Offset-2 On/Off	On
	Offset-3 On/Off	On
	Offset-4 On/Off	On
	Offset-5 On/Off	On
	Offset-6 On/Off	On
	Limit-1 REL Start Level	2.0 dB
	Limit-2 REL Start Level	2.0 dB
	Limit-3 REL Start Level	-10.0 dB
	Limit-4 REL Start Level	-32.0 dB
	Limit-5 REL Start Level	-35.0 dB
	Limit-6 REL Start Level	-45.0 dB
	Limit-1 REL Stop Level	2.0 dB
	Limit-2 REL Stop Level	-10.0 dB
	Limit-3 REL Stop Level	-32.0 dB
	Limit-4 REL Stop Level	-35.0 dB
	Limit-5 REL Stop Level	-45.0 dB
	Limit-6 REL Stop Level	-45.0 dB
	Limit-1 Fail Logic	REL
	Limit-2 Fail Logic	REL
	Limit-3 Fail Logic	REL
	Limit-4 Fail Logic	REL
	Limit-5 Fail Logic	REL
	Limit-6 Fail Logic	REL

Table C-5 Standard parameters for Spectrum Emission Mask (Cont'd)

Standard	Parameter Name	Setting
Microlink ETSI CS:28MHz Class:5B - 6B Freq Band:3G - 17GHz	Frequency Span	140 MHz
	Limit Side	Both
	Reference Mode	Peak
	Channel BW	1 kHz
	RBW	100 kHz
	VBW	300 Hz
	Sweep Time	Auto
	Auto Sweep Time Select	Fast
	Detection	Positive
	Trace Point	1001
	Filter Type	Root Nyquist
	Roll-off Factor	0.22
	Offset-1 Start Freq	0 Hz
	Offset-2 Start Freq	12 MHz
	Offset-3 Start Freq	14.5 MHz
	Offset-4 Start Freq	15.5 MHz
	Offset-5 Start Freq	17 MHz
	Offset-6 Start Freq	40 MHz
	Offset-7 Start Freq	54 MHz
	Offset-1 Stop Freq	12 MHz
	Offset-2 Stop Freq	14.5 MHz
	Offset-3 Stop Freq	15.5 MHz
	Offset-4 Stop Freq	17 MHz
	Offset-5 Stop Freq	40 MHz
	Offset-6 Stop Freq	54 MHz
	Offset-7 Stop Freq	70 MHz
	Offset-1 Reference Level	Auto
	Offset-2 Reference Level	Auto
	Offset-3 Reference Level	Auto
	Offset-4 Reference Level	Auto
	Offset-5 Reference Level	Auto
	Offset-6 Reference Level	Auto
	Offset-7 Reference Level	Auto
Offset-1 RBW	100 kHz	
Offset-2 RBW	100 kHz	
Offset-3 RBW	100 kHz	
Offset-4 RBW	100 kHz	
Offset-5 RBW	100 kHz	
Offset-6 RBW	100 kHz	
Offset-7 RBW	100 kHz	

Table C-5 Standard parameters for Spectrum Emission Mask (Cont'd)

Standard	Parameter Name	Setting
Microlink ETSI CS:28MHz Class:5B - 6B Freq Band:3G - 17GHz	Offset-1 VBW	300 Hz
	Offset-2 VBW	300 Hz
	Offset-3 VBW	300 Hz
	Offset-4 VBW	300 Hz
	Offset-5 VBW	300 Hz
	Offset-6 VBW	300 Hz
	Offset-7 VBW	300 Hz
	Offset-1 Sweep Time	Auto
	Offset-2 Sweep Time	Auto
	Offset-3 Sweep Time	Auto
	Offset-4 Sweep Time	Auto
	Offset-5 Sweep Time	Auto
	Offset-6 Sweep Time	Auto
	Offset-7 Sweep Time	Auto
	Offset-1 Auto Sweep Time Select	Fast
	Offset-2 Auto Sweep Time Select	Fast
	Offset-3 Auto Sweep Time Select	Fast
	Offset-4 Auto Sweep Time Select	Fast
	Offset-5 Auto Sweep Time Select	Fast
	Offset-6 Auto Sweep Time Select	Fast
	Offset-7 Auto Sweep Time Select	Fast
	Offset-1 Detection	Positive
	Offset-2 Detection	Positive
	Offset-3 Detection	Positive
	Offset-4 Detection	Positive
	Offset-5 Detection	Positive
	Offset-6 Detection	Positive
	Offset-7 Detection	Positive

Table C-5 Standard parameters for Spectrum Emission Mask (Cont'd)

Standard	Parameter Name	Setting
Microlink ETSI CS:28MHz Class:5B - 6B Freq Band:3G - 17GHz	Offset-1 Trace Point	1001
	Offset-2 Trace Point	1001
	Offset-3 Trace Point	1001
	Offset-4 Trace Point	1001
	Offset-5 Trace Point	1001
	Offset-6 Trace Point	1001
	Offset-7 Trace Point	1001
	Offset-1 On/Off	On
	Offset-2 On/Off	On
	Offset-3 On/Off	On
	Offset-4 On/Off	On
	Offset-5 On/Off	On
	Offset-6 On/Off	On
	Offset-7 On/Off	On
	Limit-1 REL Start Level	2.0 dB
	Limit-2 REL Start Level	2.0 dB
	Limit-3 REL Start Level	-10.0 dB
	Limit-4 REL Start Level	-32.0 dB
	Limit-5 REL Start Level	-36.0 dB
	Limit-6 REL Start Level	-45.0 dB
	Limit-7 REL Start Level	-55.0 dB
	Limit-1 REL Stop Level	2.0 dB
	Limit-2 REL Stop Level	-10.0 dB
	Limit-3 REL Stop Level	-32.0 dB
	Limit-4 REL Stop Level	-36.0 dB
	Limit-5 REL Stop Level	-45.0 dB
	Limit-6 REL Stop Level	-55.0 dB
	Limit-7 REL Stop Level	-55.0 dB
	Limit-1 Fail Logic	REL
	Limit-2 Fail Logic	REL
	Limit-3 Fail Logic	REL
Limit-4 Fail Logic	REL	
Limit-5 Fail Logic	REL	
Limit-6 Fail Logic	REL	
Limit-7 Fail Logic	REL	

Table C-5 Standard parameters for Spectrum Emission Mask (Cont'd)

Standard	Parameter Name	Setting
Microlink ETSI CS:28MHz Class:5B6B Freq Band: 17G - 30GHz	Frequency Span	140 MHz
	Limit Side	Both
	Reference Mode	Peak
	Channel BW	1 kHz
	RBW	100 kHz
	VBW	300 Hz
	Sweep Time	Auto
	Auto Sweep Time Select	Fast
	Detection	Positive
	Trace Point	1001
	Filter Type	Root Nyquist
	Roll-off Factor	0.22
	Offset-1 Start Freq	0 Hz
	Offset-2 Start Freq	12 MHz
	Offset-3 Start Freq	14.5 MHz
	Offset-4 Start Freq	15.5 MHz
	Offset-5 Start Freq	17 MHz
	Offset-6 Start Freq	40 MHz
	Offset-7 Start Freq	47 MHz
	Offset-1 Stop Freq	12 MHz
	Offset-2 Stop Freq	14.5 MHz
	Offset-3 Stop Freq	15.5 MHz
	Offset-4 Stop Freq	17 MHz
	Offset-5 Stop Freq	40 MHz
	Offset-6 Stop Freq	47 MHz
	Offset-7 Stop Freq	70 MHz
	Offset-1 Reference Level	Auto
	Offset-2 Reference Level	Auto
	Offset-3 Reference Level	Auto
	Offset-4 Reference Level	Auto
	Offset-5 Reference Level	Auto
	Offset-6 Reference Level	Auto
	Offset-7 Reference Level	Auto
Offset-1 RBW	100 kHz	
Offset-2 RBW	100 kHz	
Offset-3 RBW	100 kHz	
Offset-4 RBW	100 kHz	
Offset-5 RBW	100 kHz	
Offset-6 RBW	100 kHz	
Offset-7 RBW	100 kHz	

Table C-5 Standard parameters for Spectrum Emission Mask (Cont'd)

Standard	Parameter Name	Setting
Microlink ETSI CS:28MHz Class:5B6B Freq Band: 17G - 30GHz	Offset-1 VBW	300 Hz
	Offset-2 VBW	300 Hz
	Offset-3 VBW	300 Hz
	Offset-4 VBW	300 Hz
	Offset-5 VBW	300 Hz
	Offset-6 VBW	300 Hz
	Offset-7 VBW	300 Hz
	Offset-1 Sweep Time	Auto
	Offset-2 Sweep Time	Auto
	Offset-3 Sweep Time	Auto
	Offset-4 Sweep Time	Auto
	Offset-5 Sweep Time	Auto
	Offset-6 Sweep Time	Auto
	Offset-7 Sweep Time	Auto
	Offset-1 Auto Sweep Time Select	Fast
	Offset-2 Auto Sweep Time Select	Fast
	Offset-3 Auto Sweep Time Select	Fast
	Offset-4 Auto Sweep Time Select	Fast
	Offset-5 Auto Sweep Time Select	Fast
	Offset-6 Auto Sweep Time Select	Fast
	Offset-7 Auto Sweep Time Select	Fast
	Offset-1 Detection	Positive
	Offset-2 Detection	Positive
	Offset-3 Detection	Positive
	Offset-4 Detection	Positive
	Offset-5 Detection	Positive
	Offset-6 Detection	Positive
	Offset-7 Detection	Positive

Table C-5 Standard parameters for Spectrum Emission Mask (Cont'd)

Standard	Parameter Name	Setting
Microlink ETSI CS:28MHz Class:5B6B Freq Band: 17G - 30GHz	Offset-1 Trace Point	1001
	Offset-2 Trace Point	1001
	Offset-3 Trace Point	1001
	Offset-4 Trace Point	1001
	Offset-5 Trace Point	1001
	Offset-6 Trace Point	1001
	Offset-7 Trace Point	1001
	Offset-1 On/Off	On
	Offset-2 On/Off	On
	Offset-3 On/Off	On
	Offset-4 On/Off	On
	Offset-5 On/Off	On
	Offset-6 On/Off	On
	Offset-7 On/Off	On
	Limit-1 REL Start Level	2.0 dB
	Limit-2 REL Start Level	2.0 dB
	Limit-3 REL Start Level	-10.0 dB
	Limit-4 REL Start Level	-32.0 dB
	Limit-5 REL Start Level	-36.0 dB
	Limit-6 REL Start Level	-45.0 dB
	Limit-7 REL Start Level	-50.0 dB
	Limit-1 REL Stop Level	2.0 dB
	Limit-2 REL Stop Level	-10.0 dB
	Limit-3 REL Stop Level	-32.0 dB
	Limit-4 REL Stop Level	-36.0 dB
	Limit-5 REL Stop Level	-45.0 dB
	Limit-6 REL Stop Level	-50.0 dB
	Limit-7 REL Stop Level	-50.0 dB
	Limit-1 Fail Logic	REL
	Limit-2 Fail Logic	REL
	Limit-3 Fail Logic	REL
Limit-4 Fail Logic	REL	
Limit-5 Fail Logic	REL	
Limit-6 Fail Logic	REL	
Limit-7 Fail Logic	REL	

Table C-5 Standard parameters for Spectrum Emission Mask (Cont'd)

Standard	Parameter Name	Setting
Microlink ETSI CS:28MHz Class:5B6B Freq Band: above 30GHz	Frequency Span	140 MHz
	Limit Side	Both
	Reference Mode	Peak
	Channel BW	1 kHz
	RBW	100 kHz
	VBW	300 Hz
	Sweep Time	Auto
	Auto Sweep Time Select	Fast
	Detection	Positive
	Trace Point	1001
	Filter Type	Root Nyquist
	Roll-off Factor	0.22
	Offset-1 Start Freq	0 Hz
	Offset-2 Start Freq	12 MHz
	Offset-3 Start Freq	14.5 MHz
	Offset-4 Start Freq	15.5 MHz
	Offset-5 Start Freq	17 MHz
	Offset-6 Start Freq	40 MHz
	Offset-1 Stop Freq	12 MHz
	Offset-2 Stop Freq	14.5 MHz
	Offset-3 Stop Freq	15.5 MHz
	Offset-4 Stop Freq	17 MHz
	Offset-5 Stop Freq	40 MHz
	Offset-6 Stop Freq	70 MHz
	Offset-1 Reference Level	Auto
	Offset-2 Reference Level	Auto
	Offset-3 Reference Level	Auto
	Offset-4 Reference Level	Auto
	Offset-5 Reference Level	Auto
	Offset-6 Reference Level	Auto
Offset-1 RBW	100 kHz	
Offset-2 RBW	100 kHz	
Offset-3 RBW	100 kHz	
Offset-4 RBW	100 kHz	
Offset-5 RBW	100 kHz	
Offset-6 RBW	100 kHz	

Table C-5 Standard parameters for Spectrum Emission Mask (Cont'd)

Standard	Parameter Name	Setting
Microlink ETSI CS:28MHz Class:5B6B Freq Band: above 30GHz	Offset-1 VBW	300 Hz
	Offset-2 VBW	300 Hz
	Offset-3 VBW	300 Hz
	Offset-4 VBW	300 Hz
	Offset-5 VBW	300 Hz
	Offset-6 VBW	300 Hz
	Offset-1 Sweep Time	Auto
	Offset-2 Sweep Time	Auto
	Offset-3 Sweep Time	Auto
	Offset-4 Sweep Time	Auto
	Offset-5 Sweep Time	Auto
	Offset-6 Sweep Time	Auto
	Offset-1 Auto Sweep Time Select	Fast
	Offset-2 Auto Sweep Time Select	Fast
	Offset-3 Auto Sweep Time Select	Fast
	Offset-4 Auto Sweep Time Select	Fast
	Offset-5 Auto Sweep Time Select	Fast
	Offset-6 Auto Sweep Time Select	Fast
	Offset-1 Detection	Positive
	Offset-2 Detection	Positive
	Offset-3 Detection	Positive
	Offset-4 Detection	Positive
	Offset-5 Detection	Positive
	Offset-6 Detection	Positive
	Offset-1 Trace Point	1001
	Offset-2 Trace Point	1001
	Offset-3 Trace Point	1001
	Offset-4 Trace Point	1001
Offset-5 Trace Point	1001	
Offset-6 Trace Point	1001	

Table C-5 Standard parameters for Spectrum Emission Mask (Cont'd)

Standard	Parameter Name	Setting
Microlink ETSI CS:28MHz Class:5B6B Freq Band: above 30GHz	Offset-1 On/Off	On
	Offset-2 On/Off	On
	Offset-3 On/Off	On
	Offset-4 On/Off	On
	Offset-5 On/Off	On
	Offset-6 On/Off	On
	Limit-1 REL Start Level	2.0 dB
	Limit-2 REL Start Level	2.0 dB
	Limit-3 REL Start Level	-10.0 dB
	Limit-4 REL Start Level	-32.0 dB
	Limit-5 REL Start Level	-36.0 dB
	Limit-6 REL Start Level	-45.0 dB
	Limit-1 REL Stop Level	2.0 dB
	Limit-2 REL Stop Level	-10.0 dB
	Limit-3 REL Stop Level	-32.0 dB
	Limit-4 REL Stop Level	-36.0 dB
	Limit-5 REL Stop Level	-45.0 dB
	Limit-6 REL Stop Level	-45.0 dB
	Limit-1 Fail Logic	REL
	Limit-2 Fail Logic	REL
	Limit-3 Fail Logic	REL
	Limit-4 Fail Logic	REL
	Limit-5 Fail Logic	REL
	Limit-6 Fail Logic	REL

Microlink ETSI CS: 56MHz

Table C-5 Standard parameters for Spectrum Emission Mask (Cont'd)

Standard	Parameter Name	Setting
Microlink ETSI CS:56MHz Class:4L Freq Band:3G - 17GHz	Frequency Span	280 MHz
	Limit Side	Both
	Reference Mode	Peak
	Channel BW	1 kHz
	RBW	300 kHz
	VBW	300 Hz
	Sweep Time	Auto
	Auto Sweep Time Select	Fast
	Detection	Positive
	Trace Point	1001
	Filter Type	Root Nyquist
	Roll-off Factor	0.22
	Offset-1 Start Freq	0 Hz
	Offset-2 Start Freq	25.6 MHz
	Offset-3 Start Freq	34 MHz
	Offset-4 Start Freq	112 MHz
	Offset-1 Stop Freq	25.6 MHz
	Offset-2 Stop Freq	34 MHz
	Offset-3 Stop Freq	112 MHz
	Offset-4 Stop Freq	140 MHz
	Offset-1 Reference Level	Auto
	Offset-2 Reference Level	Auto
	Offset-3 Reference Level	Auto
	Offset-4 Reference Level	Auto
	Offset-1 RBW	300 kHz
	Offset-2 RBW	300 kHz
	Offset-3 RBW	300 kHz
	Offset-4 RBW	300 kHz
	Offset-1 VBW	300 Hz
	Offset-2 VBW	300 Hz
	Offset-3 VBW	300 Hz
	Offset-4 VBW	300 Hz
Offset-1 Sweep Time	Auto	
Offset-2 Sweep Time	Auto	
Offset-3 Sweep Time	Auto	
Offset-4 Sweep Time	Auto	

Table C-5 Standard parameters for Spectrum Emission Mask (Cont'd)

Standard	Parameter Name	Setting
Microlink ETSI CS:56MHz Class:4L Freq Band:3G - 17GHz	Offset-1 Auto Sweep Time Select	Fast
	Offset-2 Auto Sweep Time Select	Fast
	Offset-3 Auto Sweep Time Select	Fast
	Offset-4 Auto Sweep Time Select	Fast
	Offset-1 Detection	Positive
	Offset-2 Detection	Positive
	Offset-3 Detection	Positive
	Offset-4 Detection	Positive
	Offset-1 Trace Point	1001
	Offset-2 Trace Point	1001
	Offset-3 Trace Point	1001
	Offset-4 Trace Point	1001
	Offset-1 On/Off	On
	Offset-2 On/Off	On
	Offset-3 On/Off	On
	Offset-4 On/Off	On
	Limit-1 REL Start Level	2.0 dB
	Limit-2 REL Start Level	2.0 dB
	Limit-3 REL Start Level	-27.0 dB
	Limit-4 REL Start Level	-55.0 dB
	Limit-1 REL Stop Level	2.0 dB
	Limit-2 REL Stop Level	-27.0 dB
	Limit-3 REL Stop Level	-55.0 dB
	Limit-4 REL Stop Level	-55.0 dB
	Limit-1 Fail Logic	REL
	Limit-2 Fail Logic	REL
	Limit-3 Fail Logic	REL
	Limit-4 Fail Logic	REL

Table C-5 Standard parameters for Spectrum Emission Mask (Cont'd)

Standard	Parameter Name	Setting
Microlink ETSI CS:56MHz Class:4L Freq Band:17G - 30GHz	Frequency Span	280 MHz
	Limit Side	Both
	Reference Mode	Peak
	Channel BW	1 kHz
	RBW	300 kHz
	VBW	300 Hz
	Sweep Time	Auto
	Auto Sweep Time Select	Fast
	Detection	Positive
	Trace Point	1001
	Filter Type	Root Nyquist
	Roll-off Factor	0.22
	Offset-1 Start Freq	0 Hz
	Offset-2 Start Freq	25.6 MHz
	Offset-3 Start Freq	34 MHz
	Offset-4 Start Freq	98 MHz
	Offset-1 Stop Freq	25.6 MHz
	Offset-2 Stop Freq	34 MHz
	Offset-3 Stop Freq	98 MHz
	Offset-4 Stop Freq	140 MHz
	Offset-1 Reference Level	Auto
	Offset-2 Reference Level	Auto
	Offset-3 Reference Level	Auto
	Offset-4 Reference Level	Auto
	Offset-1 RBW	300 kHz
	Offset-2 RBW	300 kHz
	Offset-3 RBW	300 kHz
	Offset-4 RBW	300 kHz
	Offset-1 VBW	300 Hz
	Offset-2 VBW	300 Hz
	Offset-3 VBW	300 Hz
	Offset-4 VBW	300 Hz
Offset-1 Sweep Time	Auto	
Offset-2 Sweep Time	Auto	
Offset-3 Sweep Time	Auto	
Offset-4 Sweep Time	Auto	

Table C-5 Standard parameters for Spectrum Emission Mask (Cont'd)

Standard	Parameter Name	Setting
Microlink ETSI CS:56MHz Class:4L Freq Band:17G - 30GHz	Offset-1 Auto Sweep Time Select	Fast
	Offset-2 Auto Sweep Time Select	Fast
	Offset-3 Auto Sweep Time Select	Fast
	Offset-4 Auto Sweep Time Select	Fast
	Offset-1 Detection	Positive
	Offset-2 Detection	Positive
	Offset-3 Detection	Positive
	Offset-4 Detection	Positive
	Offset-1 Trace Point	1001
	Offset-2 Trace Point	1001
	Offset-3 Trace Point	1001
	Offset-4 Trace Point	1001
	Offset-1 On/Off	On
	Offset-2 On/Off	On
	Offset-3 On/Off	On
	Offset-4 On/Off	On
	Limit-1 REL Start Level	2.0 dB
	Limit-2 REL Start Level	2.0 dB
	Limit-3 REL Start Level	-27.0 dB
	Limit-4 REL Start Level	-50.0 dB
	Limit-1 REL Stop Level	2.0 dB
	Limit-2 REL Stop Level	-27.0 dB
	Limit-3 REL Stop Level	-50.0 dB
	Limit-4 REL Stop Level	-50.0 dB
	Limit-1 Fail Logic	REL
	Limit-2 Fail Logic	REL
	Limit-3 Fail Logic	REL
	Limit-4 Fail Logic	REL

Table C-5 Standard parameters for Spectrum Emission Mask (Cont'd)

Standard	Parameter Name	Setting
Microlink ETSI CS:56MHz Class:4L Freq Band:above 30GHz	Frequency Span	280 MHz
	Limit Side	Both
	Reference Mode	Peak
	Channel BW	1 kHz
	RBW	300 kHz
	VBW	300 Hz
	Sweep Time	Auto
	Auto Sweep Time Select	Fast
	Detection	Positive
	Trace Point	1001
	Filter Type	Root Nyquist
	Roll-off Factor	0.22
	Offset-1 Start Freq	0 Hz
	Offset-2 Start Freq	25.6 MHz
	Offset-3 Start Freq	34 MHz
	Offset-4 Start Freq	84 MHz
	Offset-1 Stop Freq	25.6 MHz
	Offset-2 Stop Freq	34 MHz
	Offset-3 Stop Freq	84 MHz
	Offset-4 Stop Freq	140 MHz
	Offset-1 Reference Level	Auto
	Offset-2 Reference Level	Auto
	Offset-3 Reference Level	Auto
	Offset-4 Reference Level	Auto
	Offset-1 RBW	300 kHz
	Offset-2 RBW	300 kHz
	Offset-3 RBW	300 kHz
	Offset-4 RBW	300 kHz
	Offset-1 VBW	300 Hz
	Offset-2 VBW	300 Hz
	Offset-3 VBW	300 Hz
	Offset-4 VBW	300 Hz
Offset-1 Sweep Time	Auto	
Offset-2 Sweep Time	Auto	
Offset-3 Sweep Time	Auto	
Offset-4 Sweep Time	Auto	

Table C-5 Standard parameters for Spectrum Emission Mask (Cont'd)

Standard	Parameter Name	Setting
Microlink ETSI CS:56MHz Class:4L Freq Band:above 30GHz	Offset-1 Auto Sweep Time Select	Fast
	Offset-2 Auto Sweep Time Select	Fast
	Offset-3 Auto Sweep Time Select	Fast
	Offset-4 Auto Sweep Time Select	Fast
	Offset-1 Detection	Positive
	Offset-2 Detection	Positive
	Offset-3 Detection	Positive
	Offset-4 Detection	Positive
	Offset-1 Trace Point	1001
	Offset-2 Trace Point	1001
	Offset-3 Trace Point	1001
	Offset-4 Trace Point	1001
	Offset-1 On/Off	On
	Offset-2 On/Off	On
	Offset-3 On/Off	On
	Offset-4 On/Off	On
	Limit-1 REL Start Level	2.0 dB
	Limit-2 REL Start Level	2.0 dB
	Limit-3 REL Start Level	-27.0 dB
	Limit-4 REL Start Level	-45.0 dB
	Limit-1 REL Stop Level	2.0 dB
	Limit-2 REL Stop Level	-27.0 dB
	Limit-3 REL Stop Level	-45.0 dB
	Limit-4 REL Stop Level	-45.0 dB
	Limit-1 Fail Logic	REL
	Limit-2 Fail Logic	REL
	Limit-3 Fail Logic	REL
	Limit-4 Fail Logic	REL

Table C-5 Standard parameters for Spectrum Emission Mask (Cont'd)

Standard	Parameter Name	Setting
Microlink ETSI CS:56MHz Class:5A6A Freq Band:3G - 17GHz	Frequency Span	280 MHz
	Limit Side	Both
	Reference Mode	Peak
	Channel BW	1 kHz
	RBW	300 kHz
	VBW	300 Hz
	Sweep Time	Auto
	Auto Sweep Time Select	Fast
	Detection	Positive
	Trace Point	1001
	Filter Type	Root Nyquist
	Roll-off Factor	0.22
	Offset-1 Start Freq	0 Hz
	Offset-2 Start Freq	25 MHz
	Offset-3 Start Freq	30 MHz
	Offset-4 Start Freq	34 MHz
	Offset-5 Start Freq	40 MHz
	Offset-6 Start Freq	80 MHz
	Offset-7 Start Freq	108 MHz
	Offset-1 Stop Freq	25 MHz
	Offset-2 Stop Freq	30 MHz
	Offset-3 Stop Freq	34 MHz
	Offset-4 Stop Freq	40 MHz
	Offset-5 Stop Freq	80 MHz
	Offset-6 Stop Freq	108 MHz
	Offset-7 Stop Freq	140 MHz
	Offset-1 Reference Level	Auto
	Offset-2 Reference Level	Auto
	Offset-3 Reference Level	Auto
	Offset-4 Reference Level	Auto
	Offset-5 Reference Level	Auto
	Offset-6 Reference Level	Auto
	Offset-7 Reference Level	Auto
Offset-1 RBW	300 kHz	
Offset-2 RBW	300 kHz	
Offset-3 RBW	300 kHz	
Offset-4 RBW	300 kHz	
Offset-5 RBW	300 kHz	
Offset-6 RBW	300 kHz	
Offset-7 RBW	300 kHz	

Table C-5 Standard parameters for Spectrum Emission Mask (Cont'd)

Standard	Parameter Name	Setting
Microlink ETSI CS:56MHz Class:5A6A Freq Band:3G - 17GHz	Offset-1 VBW	300 Hz
	Offset-2 VBW	300 Hz
	Offset-3 VBW	300 Hz
	Offset-4 VBW	300 Hz
	Offset-5 VBW	300 Hz
	Offset-6 VBW	300 Hz
	Offset-7 VBW	300 Hz
	Offset-1 Sweep Time	Auto
	Offset-2 Sweep Time	Auto
	Offset-3 Sweep Time	Auto
	Offset-4 Sweep Time	Auto
	Offset-5 Sweep Time	Auto
	Offset-6 Sweep Time	Auto
	Offset-7 Sweep Time	Auto
	Offset-1 Auto Sweep Time Select	Fast
	Offset-2 Auto Sweep Time Select	Fast
	Offset-3 Auto Sweep Time Select	Fast
	Offset-4 Auto Sweep Time Select	Fast
	Offset-5 Auto Sweep Time Select	Fast
	Offset-6 Auto Sweep Time Select	Fast
	Offset-7 Auto Sweep Time Select	Fast
	Offset-1 Detection	Positive
	Offset-2 Detection	Positive
	Offset-3 Detection	Positive
	Offset-4 Detection	Positive
	Offset-5 Detection	Positive
	Offset-6 Detection	Positive
	Offset-7 Detection	Positive

Table C-5 Standard parameters for Spectrum Emission Mask (Cont'd)

Standard	Parameter Name	Setting
Microlink ETSI CS:56MHz Class:5A6A Freq Band:3G - 17GHz	Offset-1 Trace Point	1001
	Offset-2 Trace Point	1001
	Offset-3 Trace Point	1001
	Offset-4 Trace Point	1001
	Offset-5 Trace Point	1001
	Offset-6 Trace Point	1001
	Offset-7 Trace Point	1001
	Offset-1 On/Off	On
	Offset-2 On/Off	On
	Offset-3 On/Off	On
	Offset-4 On/Off	On
	Offset-5 On/Off	On
	Offset-6 On/Off	On
	Offset-7 On/Off	On
	Limit-1 REL Start Level	2.0 dB
	Limit-2 REL Start Level	2.0 dB
	Limit-3 REL Start Level	-10.0 dB
	Limit-4 REL Start Level	-32.0 dB
	Limit-5 REL Start Level	-35.0 dB
	Limit-6 REL Start Level	-45.0 dB
	Limit-7 REL Start Level	-55.0 dB
	Limit-1 REL Stop Level	2.0 dB
	Limit-2 REL Stop Level	-10.0 dB
	Limit-3 REL Stop Level	-32.0 dB
	Limit-4 REL Stop Level	-35.0 dB
	Limit-5 REL Stop Level	-45.0 dB
	Limit-6 REL Stop Level	-55.0 dB
	Limit-7 REL Stop Level	-55.0 dB
	Limit-1 Fail Logic	REL
	Limit-2 Fail Logic	REL
	Limit-3 Fail Logic	REL
Limit-4 Fail Logic	REL	
Limit-5 Fail Logic	REL	
Limit-6 Fail Logic	REL	
Limit-7 Fail Logic	REL	

Table C-5 Standard parameters for Spectrum Emission Mask (Cont'd)

Standard	Parameter Name	Setting
Microlink ETSI CS:56MHz Class:5A - 6A Freq Band:17G - 30GHz	Frequency Span	280 MHz
	Limit Side	Both
	Reference Mode	Peak
	Channel BW	1 kHz
	RBW	300 kHz
	VBW	300 Hz
	Sweep Time	Auto
	Auto Sweep Time Select	Fast
	Detection	Positive
	Trace Point	1001
	Filter Type	Root Nyquist
	Roll-off Factor	0.22
	Offset-1 Start Freq	0 Hz
	Offset-2 Start Freq	25 MHz
	Offset-3 Start Freq	30 MHz
	Offset-4 Start Freq	34 MHz
	Offset-5 Start Freq	40 MHz
	Offset-6 Start Freq	80 MHz
	Offset-7 Start Freq	94 MHz
	Offset-1 Stop Freq	25 MHz
	Offset-2 Stop Freq	30 MHz
	Offset-3 Stop Freq	34 MHz
	Offset-4 Stop Freq	40 MHz
	Offset-5 Stop Freq	80 MHz
	Offset-6 Stop Freq	94 MHz
	Offset-7 Stop Freq	140 MHz
	Offset-1 Reference Level	Auto
	Offset-2 Reference Level	Auto
	Offset-3 Reference Level	Auto
	Offset-4 Reference Level	Auto
	Offset-5 Reference Level	Auto
	Offset-6 Reference Level	Auto
	Offset-7 Reference Level	Auto
Offset-1 RBW	300 kHz	
Offset-2 RBW	300 kHz	
Offset-3 RBW	300 kHz	
Offset-4 RBW	300 kHz	
Offset-5 RBW	300 kHz	
Offset-6 RBW	300 kHz	
Offset-7 RBW	300 kHz	

Table C-5 Standard parameters for Spectrum Emission Mask (Cont'd)

Standard	Parameter Name	Setting
Microlink ETSI CS:56MHz Class:5A - 6A Freq Band:17G - 30GHz	Offset-1 VBW	300 Hz
	Offset-2 VBW	300 Hz
	Offset-3 VBW	300 Hz
	Offset-4 VBW	300 Hz
	Offset-5 VBW	300 Hz
	Offset-6 VBW	300 Hz
	Offset-7 VBW	300 Hz
	Offset-1 Sweep Time	Auto
	Offset-2 Sweep Time	Auto
	Offset-3 Sweep Time	Auto
	Offset-4 Sweep Time	Auto
	Offset-5 Sweep Time	Auto
	Offset-6 Sweep Time	Auto
	Offset-7 Sweep Time	Auto
	Offset-1 Auto Sweep Time Select	Fast
	Offset-2 Auto Sweep Time Select	Fast
	Offset-3 Auto Sweep Time Select	Fast
	Offset-4 Auto Sweep Time Select	Fast
	Offset-5 Auto Sweep Time Select	Fast
	Offset-6 Auto Sweep Time Select	Fast
	Offset-7 Auto Sweep Time Select	Fast
	Offset-1 Detection	Positive
	Offset-2 Detection	Positive
	Offset-3 Detection	Positive
	Offset-4 Detection	Positive
	Offset-5 Detection	Positive
	Offset-6 Detection	Positive
	Offset-7 Detection	Positive

Table C-5 Standard parameters for Spectrum Emission Mask (Cont'd)

Standard	Parameter Name	Setting
Microlink ETSI CS:56MHz Class:5A - 6A Freq Band:17G - 30GHz	Offset-1 Trace Point	1001
	Offset-2 Trace Point	1001
	Offset-3 Trace Point	1001
	Offset-4 Trace Point	1001
	Offset-5 Trace Point	1001
	Offset-6 Trace Point	1001
	Offset-7 Trace Point	1001
	Offset-1 On/Off	On
	Offset-2 On/Off	On
	Offset-3 On/Off	On
	Offset-4 On/Off	On
	Offset-5 On/Off	On
	Offset-6 On/Off	On
	Offset-7 On/Off	On
	Limit-1 REL Start Level	2.0 dB
	Limit-2 REL Start Level	2.0 dB
	Limit-3 REL Start Level	-10.0 dB
	Limit-4 REL Start Level	-32.0 dB
	Limit-5 REL Start Level	-35.0 dB
	Limit-6 REL Start Level	-45.0 dB
	Limit-7 REL Start Level	-50.0 dB
	Limit-1 REL Stop Level	2.0 dB
	Limit-2 REL Stop Level	-10.0 dB
	Limit-3 REL Stop Level	-32.0 dB
	Limit-4 REL Stop Level	-35.0 dB
	Limit-5 REL Stop Level	-45.0 dB
	Limit-6 REL Stop Level	-50.0 dB
	Limit-7 REL Stop Level	-50.0 dB
	Limit-1 Fail Logic	REL
	Limit-2 Fail Logic	REL
	Limit-3 Fail Logic	REL
Limit-4 Fail Logic	REL	
Limit-5 Fail Logic	REL	
Limit-6 Fail Logic	REL	
Limit-7 Fail Logic	REL	

Appendix

Appendix C

Table C-5 Standard parameters for Spectrum Emission Mask (Cont'd)

Standard	Parameter Name	Setting
Microlink ETSI CS:56MHz Class:5A - 6A Freq Band:above 30GHz	Frequency Span	280 MHz
	Limit Side	Both
	Reference Mode	Peak
	Channel BW	1 kHz
	RBW	300 kHz
	VBW	300 Hz
	Sweep Time	Auto
	Auto Sweep Time Select	Fast
	Detection	Positive
	Trace Point	1001
	Filter Type	Root Nyquist
	Roll-off Factor	0.22
	Offset-1 Start Freq	0 Hz
	Offset-2 Start Freq	25 MHz
	Offset-3 Start Freq	30 MHz
	Offset-4 Start Freq	34 MHz
	Offset-5 Start Freq	40 MHz
	Offset-6 Start Freq	80 MHz
	Offset-1 Stop Freq	25 MHz
	Offset-2 Stop Freq	30 MHz
	Offset-3 Stop Freq	34 MHz
	Offset-4 Stop Freq	40 MHz
	Offset-5 Stop Freq	80 MHz
	Offset-6 Stop Freq	140 MHz
	Offset-1 Reference Level	Auto
	Offset-2 Reference Level	Auto
	Offset-3 Reference Level	Auto
	Offset-4 Reference Level	Auto
	Offset-5 Reference Level	Auto
	Offset-6 Reference Level	Auto
	Offset-1 RBW	300 kHz
	Offset-2 RBW	300 kHz
Offset-3 RBW	300 kHz	
Offset-4 RBW	300 kHz	
Offset-5 RBW	300 kHz	
Offset-6 RBW	300 kHz	

Table C-5 Standard parameters for Spectrum Emission Mask (Cont'd)

Standard	Parameter Name	Setting
Microlink ETSI CS:56MHz Class:5A - 6A Freq Band:above 30GHz	Offset-1 VBW	300 Hz
	Offset-2 VBW	300 Hz
	Offset-3 VBW	300 Hz
	Offset-4 VBW	300 Hz
	Offset-5 VBW	300 Hz
	Offset-6 VBW	300 Hz
	Offset-1 Sweep Time	Auto
	Offset-2 Sweep Time	Auto
	Offset-3 Sweep Time	Auto
	Offset-4 Sweep Time	Auto
	Offset-5 Sweep Time	Auto
	Offset-6 Sweep Time	Auto
	Offset-1 Auto Sweep Time Select	Fast
	Offset-2 Auto Sweep Time Select	Fast
	Offset-3 Auto Sweep Time Select	Fast
	Offset-4 Auto Sweep Time Select	Fast
	Offset-5 Auto Sweep Time Select	Fast
	Offset-6 Auto Sweep Time Select	Fast
	Offset-1 Detection	Positive
	Offset-2 Detection	Positive
	Offset-3 Detection	Positive
	Offset-4 Detection	Positive
	Offset-5 Detection	Positive
	Offset-6 Detection	Positive
	Offset-1 Trace Point	1001
	Offset-2 Trace Point	1001
	Offset-3 Trace Point	1001
	Offset-4 Trace Point	1001
Offset-5 Trace Point	1001	
Offset-6 Trace Point	1001	

Table C-5 Standard parameters for Spectrum Emission Mask (Cont'd)

Standard	Parameter Name	Setting
Microlink ETSI CS:56MHz Class:5A - 6A Freq Band:above 30GHz	Offset-1 On/Off	On
	Offset-2 On/Off	On
	Offset-3 On/Off	On
	Offset-4 On/Off	On
	Offset-5 On/Off	On
	Offset-6 On/Off	On
	Limit-1 REL Start Level	2.0 dB
	Limit-2 REL Start Level	2.0 dB
	Limit-3 REL Start Level	-10.0 dB
	Limit-4 REL Start Level	-32.0 dB
	Limit-5 REL Start Level	-35.0 dB
	Limit-6 REL Start Level	-45.0 dB
	Limit-1 REL Stop Level	2.0 dB
	Limit-2 REL Stop Level	-10.0 dB
	Limit-3 REL Stop Level	-32.0 dB
	Limit-4 REL Stop Level	-35.0 dB
	Limit-5 REL Stop Level	-45.0 dB
	Limit-6 REL Stop Level	-45.0 dB
	Limit-1 Fail Logic	REL
	Limit-2 Fail Logic	REL
	Limit-3 Fail Logic	REL
	Limit-4 Fail Logic	REL
	Limit-5 Fail Logic	REL
	Limit-6 Fail Logic	REL

Table C-5 Standard parameters for Spectrum Emission Mask (Cont'd)

Standard	Parameter Name	Setting
Microlink ETSI CS:56MHz Class:5B - 6B Freq Band:3G - 17GHz	Frequency Span	280 MHz
	Limit Side	Both
	Reference Mode	Peak
	Channel BW	1 kHz
	RBW	300 kHz
	VBW	300 Hz
	Sweep Time	Auto
	Auto Sweep Time Select	Fast
	Detection	Positive
	Trace Point	1001
	Filter Type	Root Nyquist
	Roll-off Factor	0.22
	Offset-1 Start Freq	0 Hz
	Offset-2 Start Freq	24 MHz
	Offset-3 Start Freq	29 MHz
	Offset-4 Start Freq	31 MHz
	Offset-5 Start Freq	34 MHz
	Offset-6 Start Freq	80 MHz
	Offset-7 Start Freq	108 MHz
	Offset-1 Stop Freq	24 MHz
	Offset-2 Stop Freq	29 MHz
	Offset-3 Stop Freq	31 MHz
	Offset-4 Stop Freq	34 MHz
	Offset-5 Stop Freq	80 MHz
	Offset-6 Stop Freq	108 MHz
	Offset-7 Stop Freq	140 MHz
	Offset-1 Reference Level	Auto
	Offset-2 Reference Level	Auto
	Offset-3 Reference Level	Auto
	Offset-4 Reference Level	Auto
	Offset-5 Reference Level	Auto
	Offset-6 Reference Level	Auto
	Offset-7 Reference Level	Auto
Offset-1 RBW	300 kHz	
Offset-2 RBW	300 kHz	
Offset-3 RBW	300 kHz	
Offset-4 RBW	300 kHz	
Offset-5 RBW	300 kHz	
Offset-6 RBW	300 kHz	
Offset-7 RBW	300 kHz	

Table C-5 Standard parameters for Spectrum Emission Mask (Cont'd)

Standard	Parameter Name	Setting
Microlink ETSI CS:56MHz Class:5B - 6B Freq Band:3G - 17GHz	Offset-1 VBW	300 Hz
	Offset-2 VBW	300 Hz
	Offset-3 VBW	300 Hz
	Offset-4 VBW	300 Hz
	Offset-5 VBW	300 Hz
	Offset-6 VBW	300 Hz
	Offset-7 VBW	300 Hz
	Offset-1 Sweep Time	Auto
	Offset-2 Sweep Time	Auto
	Offset-3 Sweep Time	Auto
	Offset-4 Sweep Time	Auto
	Offset-5 Sweep Time	Auto
	Offset-6 Sweep Time	Auto
	Offset-7 Sweep Time	Auto
	Offset-1 Auto Sweep Time Select	Fast
	Offset-2 Auto Sweep Time Select	Fast
	Offset-3 Auto Sweep Time Select	Fast
	Offset-4 Auto Sweep Time Select	Fast
	Offset-5 Auto Sweep Time Select	Fast
	Offset-6 Auto Sweep Time Select	Fast
	Offset-7 Auto Sweep Time Select	Fast
	Offset-1 Detection	Positive
	Offset-2 Detection	Positive
	Offset-3 Detection	Positive
	Offset-4 Detection	Positive
	Offset-5 Detection	Positive
	Offset-6 Detection	Positive
	Offset-7 Detection	Positive

Table C-5 Standard parameters for Spectrum Emission Mask (Cont'd)

Standard	Parameter Name	Setting
Microlink ETSI CS:56MHz Class:5B - 6B Freq Band:3G - 17GHz	Offset-1 Trace Point	1001
	Offset-2 Trace Point	1001
	Offset-3 Trace Point	1001
	Offset-4 Trace Point	1001
	Offset-5 Trace Point	1001
	Offset-6 Trace Point	1001
	Offset-7 Trace Point	1001
	Offset-1 On/Off	On
	Offset-2 On/Off	On
	Offset-3 On/Off	On
	Offset-4 On/Off	On
	Offset-5 On/Off	On
	Offset-6 On/Off	On
	Offset-7 On/Off	On
	Limit-1 REL Start Level	2.0 dB
	Limit-2 REL Start Level	2.0 dB
	Limit-3 REL Start Level	-10.0 dB
	Limit-4 REL Start Level	-32.0 dB
	Limit-5 REL Start Level	-36.0 dB
	Limit-6 REL Start Level	-45.0 dB
	Limit-7 REL Start Level	-55.0 dB
	Limit-1 REL Stop Level	2.0 dB
	Limit-2 REL Stop Level	-10.0 dB
	Limit-3 REL Stop Level	-32.0 dB
	Limit-4 REL Stop Level	-36.0 dB
	Limit-5 REL Stop Level	-45.0 dB
	Limit-6 REL Stop Level	-55.0 dB
	Limit-7 REL Stop Level	-55.0 dB
	Limit-1 Fail Logic	REL
	Limit-2 Fail Logic	REL
	Limit-3 Fail Logic	REL
Limit-4 Fail Logic	REL	
Limit-5 Fail Logic	REL	
Limit-6 Fail Logic	REL	
Limit-7 Fail Logic	REL	

Table C-5 Standard parameters for Spectrum Emission Mask (Cont'd)

Standard	Parameter Name	Setting
Microlink ETSI CS:56MHz Class:5B - 6B Freq Band:17G - 30GHz	Frequency Span	280 MHz
	Limit Side	Both
	Reference Mode	Peak
	Channel BW	1 kHz
	RBW	300 kHz
	VBW	300 Hz
	Sweep Time	Auto
	Auto Sweep Time Select	Fast
	Detection	Positive
	Trace Point	1001
	Filter Type	Root Nyquist
	Roll-off Factor	0.22
	Offset-1 Start Freq	0 Hz
	Offset-2 Start Freq	24 MHz
	Offset-3 Start Freq	29 MHz
	Offset-4 Start Freq	31 MHz
	Offset-5 Start Freq	34 MHz
	Offset-6 Start Freq	80 MHz
	Offset-7 Start Freq	94 MHz
	Offset-1 Stop Freq	24 MHz
	Offset-2 Stop Freq	29 MHz
	Offset-3 Stop Freq	31 MHz
	Offset-4 Stop Freq	34 MHz
	Offset-5 Stop Freq	80 MHz
	Offset-6 Stop Freq	94 MHz
	Offset-7 Stop Freq	140 MHz
	Offset-1 Reference Level	Auto
	Offset-2 Reference Level	Auto
	Offset-3 Reference Level	Auto
	Offset-4 Reference Level	Auto
	Offset-5 Reference Level	Auto
	Offset-6 Reference Level	Auto
Offset-7 Reference Level	Auto	
Offset-1 RBW	300 kHz	
Offset-2 RBW	300 kHz	
Offset-3 RBW	300 kHz	
Offset-4 RBW	300 kHz	
Offset-5 RBW	300 kHz	
Offset-6 RBW	300 kHz	
Offset-7 RBW	300 kHz	

Table C-5 Standard parameters for Spectrum Emission Mask (Cont'd)

Standard	Parameter Name	Setting
Microlink ETSI CS:56MHz Class:5B - 6B Freq Band:17G - 30GHz	Offset-1 VBW	300 Hz
	Offset-2 VBW	300 Hz
	Offset-3 VBW	300 Hz
	Offset-4 VBW	300 Hz
	Offset-5 VBW	300 Hz
	Offset-6 VBW	300 Hz
	Offset-7 VBW	300 Hz
	Offset-1 Sweep Time	Auto
	Offset-2 Sweep Time	Auto
	Offset-3 Sweep Time	Auto
	Offset-4 Sweep Time	Auto
	Offset-5 Sweep Time	Auto
	Offset-6 Sweep Time	Auto
	Offset-7 Sweep Time	Auto
	Offset-1 Auto Sweep Time Select	Fast
	Offset-2 Auto Sweep Time Select	Fast
	Offset-3 Auto Sweep Time Select	Fast
	Offset-4 Auto Sweep Time Select	Fast
	Offset-5 Auto Sweep Time Select	Fast
	Offset-6 Auto Sweep Time Select	Fast
	Offset-7 Auto Sweep Time Select	Fast
	Offset-1 Detection	Positive
	Offset-2 Detection	Positive
	Offset-3 Detection	Positive
	Offset-4 Detection	Positive
	Offset-5 Detection	Positive
	Offset-6 Detection	Positive
	Offset-7 Detection	Positive

Table C-5 Standard parameters for Spectrum Emission Mask (Cont'd)

Standard	Parameter Name	Setting
Microlink ETSI CS:56MHz Class:5B - 6B Freq Band:17G - 30GHz	Offset-1 Trace Point	1001
	Offset-2 Trace Point	1001
	Offset-3 Trace Point	1001
	Offset-4 Trace Point	1001
	Offset-5 Trace Point	1001
	Offset-6 Trace Point	1001
	Offset-7 Trace Point	1001
	Offset-1 On/Off	On
	Offset-2 On/Off	On
	Offset-3 On/Off	On
	Offset-4 On/Off	On
	Offset-5 On/Off	On
	Offset-6 On/Off	On
	Offset-7 On/Off	On
	Limit-1 REL Start Level	2.0 dB
	Limit-2 REL Start Level	2.0 dB
	Limit-3 REL Start Level	-10.0 dB
	Limit-4 REL Start Level	-32.0 dB
	Limit-5 REL Start Level	-36.0 dB
	Limit-6 REL Start Level	-45.0 dB
	Limit-7 REL Start Level	-50.0 dB
	Limit-1 REL Stop Level	2.0 dB
	Limit-2 REL Stop Level	-10.0 dB
	Limit-3 REL Stop Level	-32.0 dB
	Limit-4 REL Stop Level	-36.0 dB
	Limit-5 REL Stop Level	-45.0 dB
	Limit-6 REL Stop Level	-50.0 dB
	Limit-7 REL Stop Level	-50.0 dB
	Limit-1 Fail Logic	REL
	Limit-2 Fail Logic	REL
	Limit-3 Fail Logic	REL
Limit-4 Fail Logic	REL	
Limit-5 Fail Logic	REL	
Limit-6 Fail Logic	REL	
Limit-7 Fail Logic	REL	

Table C-5 Standard parameters for Spectrum Emission Mask (Cont'd)

Standard	Parameter Name	Setting
Microlink ETSI CS:56MHz Class:5B - 6B Freq Band:above 30GHz	Frequency Span	280 MHz
	Limit Side	Both
	Reference Mode	Peak
	Channel BW	1 kHz
	RBW	300 kHz
	VBW	300 Hz
	Sweep Time	Auto
	Auto Sweep Time Select	Fast
	Detection	Positive
	Trace Point	1001
	Filter Type	Root Nyquist
	Roll-off Factor	0.22
	Offset-1 Start Freq	0 Hz
	Offset-2 Start Freq	24 MHz
	Offset-3 Start Freq	29 MHz
	Offset-4 Start Freq	31 MHz
	Offset-5 Start Freq	34 MHz
	Offset-6 Start Freq	80 MHz
	Offset-1 Stop Freq	24 MHz
	Offset-2 Stop Freq	29 MHz
	Offset-3 Stop Freq	31 MHz
	Offset-4 Stop Freq	34 MHz
	Offset-5 Stop Freq	80 MHz
	Offset-6 Stop Freq	140 MHz
	Offset-1 Reference Level	Auto
	Offset-2 Reference Level	Auto
	Offset-3 Reference Level	Auto
	Offset-4 Reference Level	Auto
	Offset-5 Reference Level	Auto
	Offset-6 Reference Level	Auto
	Offset-1 RBW	300 kHz
	Offset-2 RBW	300 kHz
Offset-3 RBW	300 kHz	
Offset-4 RBW	300 kHz	
Offset-5 RBW	300 kHz	
Offset-6 RBW	300 kHz	

Table C-5 Standard parameters for Spectrum Emission Mask (Cont'd)

Standard	Parameter Name	Setting
Microlink ETSI CS:56MHz Class:5B - 6B Freq Band:above 30GHz	Offset-1 VBW	300 Hz
	Offset-2 VBW	300 Hz
	Offset-3 VBW	300 Hz
	Offset-4 VBW	300 Hz
	Offset-5 VBW	300 Hz
	Offset-6 VBW	300 Hz
	Offset-1 Sweep Time	Auto
	Offset-2 Sweep Time	Auto
	Offset-3 Sweep Time	Auto
	Offset-4 Sweep Time	Auto
	Offset-5 Sweep Time	Auto
	Offset-6 Sweep Time	Auto
	Offset-1 Auto Sweep Time Select	Fast
	Offset-2 Auto Sweep Time Select	Fast
	Offset-3 Auto Sweep Time Select	Fast
	Offset-4 Auto Sweep Time Select	Fast
	Offset-5 Auto Sweep Time Select	Fast
	Offset-6 Auto Sweep Time Select	Fast
	Offset-1 Detection	Positive
	Offset-2 Detection	Positive
	Offset-3 Detection	Positive
	Offset-4 Detection	Positive
	Offset-5 Detection	Positive
	Offset-6 Detection	Positive
	Offset-1 Trace Point	1001
	Offset-2 Trace Point	1001
	Offset-3 Trace Point	1001
	Offset-4 Trace Point	1001
Offset-5 Trace Point	1001	
Offset-6 Trace Point	1001	

Table C-5 Standard parameters for Spectrum Emission Mask (Cont'd)

Standard	Parameter Name	Setting
Microlink ETSI CS:56MHz Class:5B - 6B Freq Band:above 30GHz	Offset-1 On/Off	On
	Offset-2 On/Off	On
	Offset-3 On/Off	On
	Offset-4 On/Off	On
	Offset-5 On/Off	On
	Offset-6 On/Off	On
	Limit-1 REL Start Level	2.0 dB
	Limit-2 REL Start Level	2.0 dB
	Limit-3 REL Start Level	-10.0 dB
	Limit-4 REL Start Level	-32.0 dB
	Limit-5 REL Start Level	-36.0 dB
	Limit-6 REL Start Level	-45.0 dB
	Limit-1 REL Stop Level	2.0 dB
	Limit-2 REL Stop Level	-10.0 dB
	Limit-3 REL Stop Level	-32.0 dB
	Limit-4 REL Stop Level	-36.0 dB
	Limit-5 REL Stop Level	-45.0 dB
	Limit-6 REL Stop Level	-45.0 dB
	Limit-1 Fail Logic	REL
	Limit-2 Fail Logic	REL
	Limit-3 Fail Logic	REL
	Limit-4 Fail Logic	REL
	Limit-5 Fail Logic	REL
	Limit-6 Fail Logic	REL

TELEC-T403

Table C-5 Standard parameters for Spectrum Emission Mask (Cont'd)

Standard	Parameter Name	Setting
TELEC-T403 ≤18MHz 5180MHz-5240M Hz Lower (WLAN)	Limit Side	Lower
	Reference Mode	Channel
	Channel BW	20 MHz
	RBW	1 MHz
	Sweep Time	Auto
	Auto Sweep Time Select	Fast
	Detection	Positive
	Trace Point	1001
	Filter Type	Rect
	Offset-1 Start Freq	90 MHz
	Offset-2 Start Freq	98 MHz
	Offset-1 Stop Freq	98 MHz
	Offset-2 Stop Freq	100 MHz
	Offset-1 Reference Level	Auto
	Offset-2 Reference Level	Auto
	Offset-1 RBW	1 MHz
	Offset-2 RBW	1 MHz
	Offset-1 Sweep Time	Auto
	Offset-2 Sweep Time	Auto
	Offset-1 Auto Sweep Time Select	Fast
	Offset-2 Auto Sweep Time Select	Fast
	Offset-1 Detection	Positive
	Offset-2 Detection	Positive
	Offset-1 Trace Point	1001
	Offset-2 Trace Point	1001
	Offset-1 Integrate BW	Auto
	Offset-2 Integrate BW	Auto
	Offset-1 On/Off	On
	Offset-2 On/Off	On
	Offset-3 On/Off	Off
	Limit-1 ABS1 Start Level	-18.24 dB
	Limit-2 ABS1 Start Level	-26.02 dB
Limit-1 ABS1 Stop Level	-18.24 dB	
Limit-2 ABS1 Stop Level	-26.02 dB	
Limit-1 Fail Logic	ABS1	
Limit-2 Fail Logic	ABS1	

Table C-5 Standard parameters for Spectrum Emission Mask (Cont'd)

Standard	Parameter Name	Setting
TELEC-T403 ≤18MHz 5180MHz-5240M Hz Upper (WLAN)	Limit Side	Upper
	Reference Mode	Channel
	Channel BW	20 MHz
	RBW	1 MHz
	Sweep Time	Auto
	Auto Sweep Time Select	Fast
	Detection	Positive
	Trace Point	1001
	Filter Type	Rect
	Offset-1 Start Freq	10 MHz
	Offset-2 Start Freq	11 MHz
	Offset-3 Start Freq	20 MHz
	Offset-4 Start Freq	26.7 MHz
	Offset-1 Stop Freq	11 MHz
	Offset-2 Stop Freq	20 MHz
	Offset-3 Stop Freq	26.7 MHz
	Offset-4 Stop Freq	120 MHz
	Offset-1 Reference Level	Auto
	Offset-2 Reference Level	Auto
	Offset-3 Reference Level	Auto
	Offset-4 Reference Level	Auto
	Offset-1 RBW	1 MHz
	Offset-2 RBW	1 MHz
	Offset-3 RBW	1 MHz
	Offset-4 RBW	1 MHz
	Offset-1 Sweep Time	Auto
	Offset-2 Sweep Time	Auto
	Offset-3 Sweep Time	Auto
	Offset-4 Sweep Time	Auto
	Offset-1 Auto Sweep Time Select	Fast
	Offset-2 Auto Sweep Time Select	Fast
	Offset-3 Auto Sweep Time Select	Fast
Offset-4 Auto Sweep Time Select	Fast	
Offset-1 Detection	Positive	
Offset-2 Detection	Positive	
Offset-3 Detection	Positive	
Offset-4 Detection	Positive	

Table C-5 Standard parameters for Spectrum Emission Mask (Cont'd)

Standard	Parameter Name	Setting
TELEC-T403 ≤18MHz 5180MHz-5240M Hz Upper (WLAN)	Offset-1 Trace Point	1001
	Offset-2 Trace Point	1001
	Offset-3 Trace Point	1001
	Offset-4 Trace Point	1001
	Offset-1 Integrate BW	Auto
	Offset-2 Integrate BW	Auto
	Offset-3 Integrate BW	Auto
	Offset-4 Integrate BW	Auto
	Offset-1 On/Off	On
	Offset-2 On/Off	On
	Offset-3 On/Off	On
	Offset-4 On/Off	On
	Offset-5 On/Off	Off
	Limit-1 ABS1 Start Level	0.0 dB
	Limit-2 ABS1 Start Level	-10.0 dB
	Limit-3 ABS1 Start Level	-18.01 dB
	Limit-4 ABS1 Start Level	-26.02 dB
	Limit-1 ABS1 Stop Level	-10.0 dB
	Limit-2 ABS1 Stop Level	-18.01 dB
	Limit-3 ABS1 Stop Level	-26.02 dB
	Limit-4 ABS1 Stop Level	-26.02 dB
	Limit-1 Fail Logic	ABS1
	Limit-2 Fail Logic	ABS1
	Limit-3 Fail Logic	ABS1
Limit-4 Fail Logic	ABS1	

Table C-5 Standard parameters for Spectrum Emission Mask (Cont'd)

Standard	Parameter Name	Setting
TELEC-T403 ≤18MHz 5260MHz-5320M Hz Lower (WLAN)	Limit Side	Lower
	Reference Mode	Channel
	Channel BW	20 MHz
	RBW	1 MHz
	Sweep Time	Auto
	Auto Sweep Time Select	Fast
	Detection	Positive
	Trace Point	1001
	Filter Type	Rect
	Offset-1 Start Freq	10 MHz
	Offset-2 Start Freq	11 MHz
	Offset-3 Start Freq	20 MHz
	Offset-4 Start Freq	26.7 MHz
	Offset-1 Stop Freq	11 MHz
	Offset-2 Stop Freq	20 MHz
	Offset-3 Stop Freq	26.7 MHz
	Offset-4 Stop Freq	120 MHz
	Offset-1 Reference Level	Auto
	Offset-2 Reference Level	Auto
	Offset-3 Reference Level	Auto
	Offset-4 Reference Level	Auto
	Offset-1 RBW	1 MHz
	Offset-2 RBW	1 MHz
	Offset-3 RBW	1 MHz
	Offset-4 RBW	1 MHz
	Offset-1 Sweep Time	Auto
	Offset-2 Sweep Time	Auto
	Offset-3 Sweep Time	Auto
	Offset-4 Sweep Time	Auto
	Offset-1 Auto Sweep Time Select	Fast
	Offset-2 Auto Sweep Time Select	Fast
	Offset-3 Auto Sweep Time Select	Fast
Offset-4 Auto Sweep Time Select	Fast	
Offset-1 Detection	Positive	
Offset-2 Detection	Positive	
Offset-3 Detection	Positive	
Offset-4 Detection	Positive	

Table C-5 Standard parameters for Spectrum Emission Mask (Cont'd)

Standard	Parameter Name	Setting
TELEC-T403 ≤18MHz 5260MHz-5320M Hz Lower (WLAN)	Offset-1 Trace Point	1001
	Offset-2 Trace Point	1001
	Offset-3 Trace Point	1001
	Offset-4 Trace Point	1001
	Offset-1 Integrate BW	Auto
	Offset-2 Integrate BW	Auto
	Offset-3 Integrate BW	Auto
	Offset-4 Integrate BW	Auto
	Offset-1 On/Off	On
	Offset-2 On/Off	On
	Offset-3 On/Off	On
	Offset-4 On/Off	On
	Offset-5 On/Off	Off
	Limit-1 ABS1 Start Level	0.0 dB
	Limit-2 ABS1 Start Level	-10.0 dB
	Limit-3 ABS1 Start Level	-18.01 dB
	Limit-4 ABS1 Start Level	-26.02 dB
	Limit-1 ABS1 Stop Level	-10.0 dB
	Limit-2 ABS1 Stop Level	-18.01 dB
	Limit-3 ABS1 Stop Level	-26.02 dB
Limit-4 ABS1 Stop Level	-26.02 dB	
Limit-1 Fail Logic	ABS1	
Limit-2 Fail Logic	ABS1	
Limit-3 Fail Logic	ABS1	
Limit-4 Fail Logic	ABS1	

Table C-5 Standard parameters for Spectrum Emission Mask (Cont'd)

Standard	Parameter Name	Setting
TELEC-T403 ≤18MHz 5260MHz-5320M Hz Upper (WLAN)	Limit Side	Upper
	Reference Mode	Channel
	Channel BW	20 MHz
	RBW	1 MHz
	Sweep Time	Auto
	Auto Sweep Time Select	Fast
	Detection	Positive
	Trace Point	1001
	Filter Type	Rect
	Offset-1 Start Freq	90 MHz
	Offset-1 Stop Freq	100 MHz
	Offset-1 Reference Level	Auto
	Offset-1 RBW	1 MHz
	Offset-1 Sweep Time	Auto
	Offset-1 Auto Sweep Time Select	Fast
	Offset-1 Detection	Positive
	Offset-1 Trace Point	1001
	Offset-1 Integrate BW	Auto
	Offset-1 On/Off	On
	Offset-2 On/Off	Off
	Limit-1 ABS1 Start Level	-26.02 dB
Limit-1 ABS1 Stop Level	-26.02 dB	
Limit-1 Fail Logic	ABS1	

Table C-5 Standard parameters for Spectrum Emission Mask (Cont'd)

Standard	Parameter Name	Setting
TELEC-T403 18MHz < , ≤19MHz 5180MHz-5240M Hz Lower (WLAN)	Limit Side	Lower
	Reference Mode	Channel
	Channel BW	20 MHz
	RBW	1 MHz
	Sweep Time	Auto
	Auto Sweep Time Select	Fast
	Detection	Positive
	Trace Point	1001
	Filter Type	Rect
	Offset-1 Start Freq	30 MHz
	Offset-2 Start Freq	38 MHz
	Offset-1 Stop Freq	38 MHz
	Offset-2 Stop Freq	45 MHz
	Offset-1 Reference Level	Auto
	Offset-2 Reference Level	Auto
	Offset-1 RBW	1 MHz
	Offset-2 RBW	1 MHz
	Offset-1 Sweep Time	Auto
	Offset-2 Sweep Time	Auto
	Offset-1 Auto Sweep Time Select	Fast
	Offset-2 Auto Sweep Time Select	Fast
	Offset-1 Detection	Positive
	Offset-2 Detection	Positive
	Offset-1 Trace Point	1001
	Offset-2 Trace Point	1001
	Offset-1 Integrate BW	Auto
	Offset-2 Integrate BW	Auto
	Offset-1 On/Off	On
	Offset-2 On/Off	On
	Offset-3 On/Off	Off
	Limit-1 ABS1 Start Level	-18.24 dB
	Limit-2 ABS1 Start Level	-26.02 dB
	Limit-1 ABS1 Stop Level	-18.24 dB
Limit-2 ABS1 Stop Level	-26.02 dB	
Limit-1 Fail Logic	ABS1	
Limit-2 Fail Logic	ABS1	

Table C-5 Standard parameters for Spectrum Emission Mask (Cont'd)

Standard	Parameter Name	Setting
TELEC-T403 18MHz < , ≤19MHz 5180MHz-5240M Hz Upper (WLAN)	Limit Side	Upper
	Reference Mode	Channel
	Channel BW	20 MHz
	RBW	1 MHz
	Sweep Time	Auto
	Auto Sweep Time Select	Fast
	Detection	Positive
	Trace Point	1001
	Filter Type	Rect
	Offset-1 Start Freq	10 MHz
	Offset-2 Start Freq	11 MHz
	Offset-3 Start Freq	20 MHz
	Offset-4 Start Freq	26.7 MHz
	Offset-1 Stop Freq	11 MHz
	Offset-2 Stop Freq	20 MHz
	Offset-3 Stop Freq	26.7 MHz
	Offset-4 Stop Freq	125 MHz
	Offset-1 Reference Level	Auto
	Offset-2 Reference Level	Auto
	Offset-3 Reference Level	Auto
	Offset-4 Reference Level	Auto
	Offset-1 RBW	1 MHz
	Offset-2 RBW	1 MHz
	Offset-3 RBW	1 MHz
	Offset-4 RBW	1 MHz
	Offset-1 Sweep Time	Auto
	Offset-2 Sweep Time	Auto
	Offset-3 Sweep Time	Auto
	Offset-4 Sweep Time	Auto
	Offset-1 Auto Sweep Time Select	Fast
	Offset-2 Auto Sweep Time Select	Fast
	Offset-3 Auto Sweep Time Select	Fast
Offset-4 Auto Sweep Time Select	Fast	
Offset-1 Detection	Positive	
Offset-2 Detection	Positive	
Offset-3 Detection	Positive	
Offset-4 Detection	Positive	

Table C-5 Standard parameters for Spectrum Emission Mask (Cont'd)

Standard	Parameter Name	Setting
TELEC-T403 18MHz < , ≤19MHz 5180MHz-5240M Hz Upper (WLAN)	Offset-1 Trace Point	1001
	Offset-2 Trace Point	1001
	Offset-3 Trace Point	1001
	Offset-4 Trace Point	1001
	Offset-1 Integrate BW	Auto
	Offset-2 Integrate BW	Auto
	Offset-3 Integrate BW	Auto
	Offset-4 Integrate BW	Auto
	Offset-1 On/Off	On
	Offset-2 On/Off	On
	Offset-3 On/Off	On
	Offset-4 On/Off	On
	Offset-5 On/Off	Off
	Limit-1 ABS1 Start Level	0.0 dB
	Limit-2 ABS1 Start Level	-10.0 dB
	Limit-3 ABS1 Start Level	-18.01 dB
	Limit-4 ABS1 Start Level	-26.02 dB
	Limit-1 ABS1 Stop Level	-10.0 dB
	Limit-2 ABS1 Stop Level	-18.01 dB
	Limit-3 ABS1 Stop Level	-26.02 dB
Limit-4 ABS1 Stop Level	-26.02 dB	
Limit-1 Fail Logic	ABS1	
Limit-2 Fail Logic	ABS1	
Limit-3 Fail Logic	ABS1	
Limit-4 Fail Logic	ABS1	

Table C-5 Standard parameters for Spectrum Emission Mask (Cont'd)

Standard	Parameter Name	Setting
TELEC-T403 18MHz < , ≤19MHz 5260MHz-5320M Hz Lower (WLAN)	Limit Side	Lower
	Reference Mode	Channel
	Channel BW	20 MHz
	RBW	1 MHz
	Sweep Time	Auto
	Auto Sweep Time Select	Fast
	Detection	Positive
	Trace Point	1001
	Filter Type	Rect
	Offset-1 Start Freq	10 MHz
	Offset-2 Start Freq	11 MHz
	Offset-3 Start Freq	20 MHz
	Offset-4 Start Freq	26.7 MHz
	Offset-1 Stop Freq	11 MHz
	Offset-2 Stop Freq	20 MHz
	Offset-3 Stop Freq	26.7 MHz
	Offset-4 Stop Freq	125 MHz
	Offset-1 Reference Level	Auto
	Offset-2 Reference Level	Auto
	Offset-3 Reference Level	Auto
	Offset-4 Reference Level	Auto
	Offset-1 RBW	1 MHz
	Offset-2 RBW	1 MHz
	Offset-3 RBW	1 MHz
	Offset-4 RBW	1 MHz
	Offset-1 Sweep Time	Auto
	Offset-2 Sweep Time	Auto
	Offset-3 Sweep Time	Auto
	Offset-4 Sweep Time	Auto
	Offset-1 Auto Sweep Time Select	Fast
	Offset-2 Auto Sweep Time Select	Fast
	Offset-3 Auto Sweep Time Select	Fast
Offset-4 Auto Sweep Time Select	Fast	
Offset-1 Detection	Positive	
Offset-2 Detection	Positive	
Offset-3 Detection	Positive	
Offset-4 Detection	Positive	

Table C-5 Standard parameters for Spectrum Emission Mask (Cont'd)

Standard	Parameter Name	Setting
TELEC-T403 18MHz < , ≤19MHz 5260MHz-5320M Hz Lower (WLAN)	Offset-1 Trace Point	1001
	Offset-2 Trace Point	1001
	Offset-3 Trace Point	1001
	Offset-4 Trace Point	1001
	Offset-1 Integrate BW	Auto
	Offset-2 Integrate BW	Auto
	Offset-3 Integrate BW	Auto
	Offset-4 Integrate BW	Auto
	Offset-1 On/Off	On
	Offset-2 On/Off	On
	Offset-3 On/Off	On
	Offset-4 On/Off	On
	Offset-5 On/Off	Off
	Limit-1 ABS1 Start Level	0.0 dB
	Limit-2 ABS1 Start Level	-10.0 dB
	Limit-3 ABS1 Start Level	-18.01 dB
	Limit-4 ABS1 Start Level	-26.02 dB
	Limit-1 ABS1 Stop Level	-10.0 dB
	Limit-2 ABS1 Stop Level	-18.01 dB
	Limit-3 ABS1 Stop Level	-26.02 dB
	Limit-4 ABS1 Stop Level	-26.02 dB
	Limit-1 Fail Logic	ABS1
	Limit-2 Fail Logic	ABS1
	Limit-3 Fail Logic	ABS1
Limit-4 Fail Logic	ABS1	

Table C-5 Standard parameters for Spectrum Emission Mask (Cont'd)

Standard	Parameter Name	Setting
TELEC-T403 18MHz < , ≤19MHz 5260MHz-5320M Hz Upper (WLAN)	Limit Side	Upper
	Reference Mode	Channel
	Channel BW	20 MHz
	RBW	1 MHz
	Sweep Time	Auto
	Auto Sweep Time Select	Fast
	Detection	Positive
	Trace Point	1001
	Filter Type	Rect
	Offset-1 Start Freq	30 MHz
	Offset-1 Stop Freq	45 MHz
	Offset-1 Reference Level	Auto
	Offset-1 RBW	1 MHz
	Offset-1 Sweep Time	Auto
	Offset-1 Auto Sweep Time Select	Fast
	Offset-1 Detection	Positive
	Offset-1 Trace Point	1001
	Offset-1 Integrate BW	Auto
	Offset-1 On/Off	On
	Offset-2 On/Off	Off
Limit-1 ABS1 Start Level	-26.02 dB	
Limit-1 ABS1 Stop Level	-26.02 dB	
Limit-1 Fail Logic	ABS1	

Table C-5 Standard parameters for Spectrum Emission Mask (Cont'd)

Standard	Parameter Name	Setting
TELEC-T403 5190MHz-5230M Hz Lower (WLAN)	Limit Side	Lower
	Reference Mode	Channel
	Channel BW	40 MHz
	RBW	1 MHz
	Sweep Time	Auto
	Auto Sweep Time Select	Fast
	Detection	Positive
	Trace Point	1001
	Filter Type	Rect
	Offset-1 Start Freq	40 MHz
	Offset-2 Start Freq	48.4 MHz
	Offset-1 Stop Freq	48.4 MHz
	Offset-2 Stop Freq	90 MHz
	Offset-1 Reference Level	Auto
	Offset-2 Reference Level	Auto
	Offset-1 RBW	1 MHz
	Offset-2 RBW	1 MHz
	Offset-1 Sweep Time	Auto
	Offset-2 Sweep Time	Auto
	Offset-1 Auto Sweep Time Select	Fast
	Offset-2 Auto Sweep Time Select	Fast
	Offset-1 Detection	Positive
	Offset-2 Detection	Positive
	Offset-1 Trace Point	1001
	Offset-2 Trace Point	1001
	Offset-1 Integrate BW	Auto
	Offset-2 Integrate BW	Auto
	Offset-1 On/Off	On
	Offset-2 On/Off	On
	Offset-3 On/Off	Off
	Limit-1 ABS1 Start Level	-18.24 dB
	Limit-2 ABS1 Start Level	-26.02 dB
	Limit-1 ABS1 Stop Level	-18.24 dB
Limit-2 ABS1 Stop Level	-26.02 dB	
Limit-1 Fail Logic	ABS1	
Limit-2 Fail Logic	ABS1	

Table C-5 Standard parameters for Spectrum Emission Mask (Cont'd)

Standard	Parameter Name	Setting
TELEC-T403 5190MHz-5230M Hz Upper (WLAN)	Limit Side	Upper
	Reference Mode	Channel
	Channel BW	40 MHz
	RBW	1 MHz
	Sweep Time	Auto
	Auto Sweep Time Select	Fast
	Detection	Positive
	Trace Point	1001
	Filter Type	Rect
	Offset-1 Start Freq	20 MHz
	Offset-2 Start Freq	21 MHz
	Offset-3 Start Freq	40 MHz
	Offset-4 Start Freq	48.4 MHz
	Offset-1 Stop Freq	21 MHz
	Offset-2 Stop Freq	40 MHz
	Offset-3 Stop Freq	48.4 MHz
	Offset-4 Stop Freq	170 MHz
	Offset-1 Reference Level	Auto
	Offset-2 Reference Level	Auto
	Offset-3 Reference Level	Auto
	Offset-4 Reference Level	Auto
	Offset-1 RBW	1 MHz
	Offset-2 RBW	1 MHz
	Offset-3 RBW	1 MHz
	Offset-4 RBW	1 MHz
	Offset-1 Sweep Time	Auto
	Offset-2 Sweep Time	Auto
	Offset-3 Sweep Time	Auto
	Offset-4 Sweep Time	Auto
	Offset-1 Auto Sweep Time Select	Fast
	Offset-2 Auto Sweep Time Select	Fast
	Offset-3 Auto Sweep Time Select	Fast
Offset-4 Auto Sweep Time Select	Fast	
Offset-1 Detection	Positive	
Offset-2 Detection	Positive	
Offset-3 Detection	Positive	
Offset-4 Detection	Positive	

Table C-5 Standard parameters for Spectrum Emission Mask (Cont'd)

Standard	Parameter Name	Setting
TELEC-T403 5190MHz-5230M Hz Upper (WLAN)	Offset-1 Trace Point	1001
	Offset-2 Trace Point	1001
	Offset-3 Trace Point	1001
	Offset-4 Trace Point	1001
	Offset-1 Integrate BW	Auto
	Offset-2 Integrate BW	Auto
	Offset-3 Integrate BW	Auto
	Offset-4 Integrate BW	Auto
	Offset-1 On/Off	On
	Offset-2 On/Off	On
	Offset-3 On/Off	On
	Offset-4 On/Off	On
	Offset-5 On/Off	Off
	Limit-1 ABS1 Start Level	-3.01 dB
	Limit-2 ABS1 Start Level	-13.01 dB
	Limit-3 ABS1 Start Level	-21.02 dB
	Limit-4 ABS1 Start Level	-26.02 dB
	Limit-1 ABS1 Stop Level	-13.01 dB
	Limit-2 ABS1 Stop Level	-21.02 dB
	Limit-3 ABS1 Stop Level	-26.02 dB
	Limit-4 ABS1 Stop Level	-26.02 dB
	Limit-1 Fail Logic	ABS1
	Limit-2 Fail Logic	ABS1
	Limit-3 Fail Logic	ABS1
Limit-4 Fail Logic	ABS1	

Table C-5 Standard parameters for Spectrum Emission Mask (Cont'd)

Standard	Parameter Name	Setting
TELEC-T403 5270MHz-5310M Hz Lower (WLAN)	Limit Side	Lower
	Reference Mode	Channel
	Channel BW	40 MHz
	RBW	1 MHz
	Sweep Time	Auto
	Auto Sweep Time Select	Fast
	Detection	Positive
	Trace Point	1001
	Filter Type	Rect
	Offset-1 Start Freq	20 MHz
	Offset-2 Start Freq	21 MHz
	Offset-3 Start Freq	40 MHz
	Offset-4 Start Freq	48.4 MHz
	Offset-5 Start Freq	60.0 MHz
	Offset-1 Stop Freq	21 MHz
	Offset-2 Stop Freq	40 MHz
	Offset-3 Stop Freq	48.4 MHz
	Offset-4 Stop Freq	60 MHz
	Offset-5 Stop Freq	170 MHz
	Offset-1 Reference Level	Auto
	Offset-2 Reference Level	Auto
	Offset-3 Reference Level	Auto
	Offset-4 Reference Level	Auto
	Offset-5 Reference Level	Auto
	Offset-1 RBW	1 MHz
	Offset-2 RBW	1 MHz
	Offset-3 RBW	1 MHz
	Offset-4 RBW	1 MHz
	Offset-5 RBW	1 MHz
	Offset-1 Sweep Time	Auto
Offset-2 Sweep Time	Auto	
Offset-3 Sweep Time	Auto	
Offset-4 Sweep Time	Auto	
Offset-5 Sweep Time	Auto	

Table C-5 Standard parameters for Spectrum Emission Mask (Cont'd)

Standard	Parameter Name	Setting
TELEC-T403 5270MHz-5310M Hz Lower (WLAN)	Offset-1 Auto Sweep Time Select	Fast
	Offset-2 Auto Sweep Time Select	Fast
	Offset-3 Auto Sweep Time Select	Fast
	Offset-4 Auto Sweep Time Select	Fast
	Offset-5 Auto Sweep Time Select	Fast
	Offset-1 Detection	Positive
	Offset-2 Detection	Positive
	Offset-3 Detection	Positive
	Offset-4 Detection	Positive
	Offset-5 Detection	Positive
	Offset-1 Trace Point	1001
	Offset-2 Trace Point	1001
	Offset-3 Trace Point	1001
	Offset-4 Trace Point	1001
	Offset-5 Trace Point	1001
	Offset-1 Integrate BW	Auto
	Offset-2 Integrate BW	Auto
	Offset-3 Integrate BW	Auto
	Offset-4 Integrate BW	Auto
	Offset-5 Integrate BW	Auto
	Offset-1 On/Off	On
	Offset-2 On/Off	On
	Offset-3 On/Off	On
	Offset-4 On/Off	On
Offset-5 On/Off	On	
Offset-6 On/Off	Off	

Table C-5 Standard parameters for Spectrum Emission Mask (Cont'd)

Standard	Parameter Name	Setting
TELEC-T403 5270MHz-5310M Hz Lower (WLAN)	Limit-1 ABS1 Start Level	-3.01 dB
	Limit-2 ABS1 Start Level	-13.01 dB
	Limit-3 ABS1 Start Level	-21.02 dB
	Limit-4 ABS1 Start Level	-26.02 dB
	Limit-5 ABS1 Start Level	-26.02 dB
	Limit-1 ABS1 Stop Level	-13.01 dB
	Limit-2 ABS1 Stop Level	-21.02 dB
	Limit-3 ABS1 Stop Level	-26.02 dB
	Limit-4 ABS1 Stop Level	-26.02 dB
	Limit-5 ABS1 Stop Level	-26.02 dB
	Limit-1 Fail Logic	ABS1
	Limit-2 Fail Logic	ABS1
	Limit-3 Fail Logic	ABS1
	Limit-4 Fail Logic	ABS1
	Limit-5 Fail Logic	ABS1

Table C-5 Standard parameters for Spectrum Emission Mask (Cont'd)

Standard	Parameter Name	Setting
TELEC-T403 5270MHz-5310M Hz Upper (WLAN)	Limit Side	Upper
	Reference Mode	Channel
	Channel BW	40 MHz
	RBW	1 MHz
	Sweep Time	Auto
	Auto Sweep Time Select	Fast
	Detection	Positive
	Trace Point	1001
	Filter Type	Rect
	Offset-1 Start Freq	40 MHz
	Offset-2 Start Freq	48.4 MHz
	Offset-1 Stop Freq	48.4 MHz
	Offset-2 Stop Freq	90 MHz
	Offset-1 Reference Level	Auto
	Offset-2 Reference Level	Auto
	Offset-1 RBW	1 MHz
	Offset-2 RBW	1 MHz
	Offset-1 Sweep Time	Auto
	Offset-2 Sweep Time	Auto
	Offset-1 Auto Sweep Time Select	Fast
	Offset-2 Auto Sweep Time Select	Fast
	Offset-1 Detection	Positive
	Offset-2 Detection	Positive
	Offset-1 Trace Point	1001
	Offset-2 Trace Point	1001
	Offset-1 Integrate BW	Auto
	Offset-2 Integrate BW	Auto
	Offset-1 On/Off	On
	Offset-2 On/Off	On
	Offset-3 On/Off	Off
	Limit-1 ABS1 Start Level	-18.24 dB
	Limit-2 ABS1 Start Level	-26.02 dB
	Limit-1 ABS1 Stop Level	-18.24 dB
Limit-2 ABS1 Stop Level	-26.02 dB	
Limit-1 Fail Logic	ABS1	
Limit-2 Fail Logic	ABS1	

Table C-5 Standard parameters for Spectrum Emission Mask (Cont'd)

Standard	Parameter Name	Setting
TELEC-T403 5210MHz Lower (WLAN)	Limit Side	Lower
	Reference Mode	Channel
	Channel BW	80 MHz
	RBW	1 MHz
	Sweep Time	Auto
	Auto Sweep Time Select	Fast
	Detection	Positive
	Trace Point	1001
	Filter Type	Rect
	Offset-1 Start Freq	60 MHz
	Offset-2 Start Freq	86.8 MHz
	Offset-1 Stop Freq	86.8 MHz
	Offset-2 Stop Freq	190 MHz
	Offset-1 Reference Level	Auto
	Offset-2 Reference Level	Auto
	Offset-1 RBW	1 MHz
	Offset-2 RBW	1 MHz
	Offset-1 Sweep Time	Auto
	Offset-2 Sweep Time	Auto
	Offset-1 Auto Sweep Time Select	Fast
	Offset-2 Auto Sweep Time Select	Fast
	Offset-1 Detection	Positive
	Offset-2 Detection	Positive
	Offset-1 Trace Point	1001
	Offset-2 Trace Point	1001
	Offset-1 Integrate BW	Auto
	Offset-2 Integrate BW	Auto
	Offset-1 On/Off	On
	Offset-2 On/Off	On
	Offset-3 On/Off	Off
	Limit-1 ABS1 Start Level	-18.24 dB
	Limit-2 ABS1 Start Level	-26.02 dB
	Limit-1 ABS1 Stop Level	-18.24 dB
Limit-2 ABS1 Stop Level	-26.02 dB	
Limit-1 Fail Logic	ABS1	
Limit-2 Fail Logic	ABS1	

Table C-5 Standard parameters for Spectrum Emission Mask (Cont'd)

Standard	Parameter Name	Setting
TELEC-T403 5210MHz Upper (WLAN)	Limit Side	Upper
	Reference Mode	Channel
	Channel BW	80 MHz
	RBW	1 MHz
	Sweep Time	Auto
	Auto Sweep Time Select	Fast
	Detection	Positive
	Trace Point	1001
	Filter Type	Rect
	Offset-1 Start Freq	40 MHz
	Offset-2 Start Freq	41 MHz
	Offset-3 Start Freq	80 MHz
	Offset-4 Start Freq	86.7 MHz
	Offset-1 Stop Freq	41 MHz
	Offset-2 Stop Freq	80 MHz
	Offset-3 Stop Freq	86.7 MHz
	Offset-4 Stop Freq	270 MHz
	Offset-1 Reference Level	Auto
	Offset-2 Reference Level	Auto
	Offset-3 Reference Level	Auto
	Offset-4 Reference Level	Auto
	Offset-1 RBW	1 MHz
	Offset-2 RBW	1 MHz
	Offset-3 RBW	1 MHz
	Offset-4 RBW	1 MHz
	Offset-1 Sweep Time	Auto
	Offset-2 Sweep Time	Auto
	Offset-3 Sweep Time	Auto
	Offset-4 Sweep Time	Auto
	Offset-1 Auto Sweep Time Select	Fast
	Offset-2 Auto Sweep Time Select	Fast
	Offset-3 Auto Sweep Time Select	Fast
	Offset-4 Auto Sweep Time Select	Fast
Offset-1 Detection	Positive	
Offset-2 Detection	Positive	
Offset-3 Detection	Positive	
Offset-4 Detection	Positive	

Table C-5 Standard parameters for Spectrum Emission Mask (Cont'd)

Standard	Parameter Name	Setting
TELEC-T403 5210MHz Upper (WLAN)	Offset-1 Trace Point	1001
	Offset-2 Trace Point	1001
	Offset-3 Trace Point	1001
	Offset-4 Trace Point	1001
	Offset-1 Integrate BW	Auto
	Offset-2 Integrate BW	Auto
	Offset-3 Integrate BW	Auto
	Offset-4 Integrate BW	Auto
	Offset-1 On/Off	On
	Offset-2 On/Off	On
	Offset-3 On/Off	On
	Offset-4 On/Off	On
	Offset-5 On/Off	Off
	Limit-1 ABS1 Start Level	-6.02 dB
	Limit-2 ABS1 Start Level	-16.02 dB
	Limit-3 ABS1 Start Level	-23.98 dB
	Limit-4 ABS1 Start Level	-26.02 dB
	Limit-1 ABS1 Stop Level	-16.02 dB
	Limit-2 ABS1 Stop Level	-23.98 dB
	Limit-3 ABS1 Stop Level	-26.02 dB
	Limit-4 ABS1 Stop Level	-26.02 dB
	Limit-1 Fail Logic	ABS1
	Limit-2 Fail Logic	ABS1
	Limit-3 Fail Logic	ABS1
Limit-4 Fail Logic	ABS1	

Table C-5 Standard parameters for Spectrum Emission Mask (Cont'd)

Standard	Parameter Name	Setting
TELEC-T403 5290MHz Lower (WLAN)	Limit Side	Lower
	Reference Mode	Channel
	Channel BW	80 MHz
	RBW	1 MHz
	Sweep Time	Auto
	Auto Sweep Time Select	Fast
	Detection	Positive
	Trace Point	1001
	Filter Type	Rect
	Offset-1 Start Freq	40 MHz
	Offset-2 Start Freq	41 MHz
	Offset-3 Start Freq	80 MHz
	Offset-4 Start Freq	86.7 MHz
	Offset-1 Stop Freq	41 MHz
	Offset-2 Stop Freq	80 MHz
	Offset-3 Stop Freq	86.7 MHz
	Offset-4 Stop Freq	270 MHz
	Offset-1 Reference Level	Auto
	Offset-2 Reference Level	Auto
	Offset-3 Reference Level	Auto
	Offset-4 Reference Level	Auto
	Offset-1 RBW	1 MHz
	Offset-2 RBW	1 MHz
	Offset-3 RBW	1 MHz
	Offset-4 RBW	1 MHz
	Offset-1 Sweep Time	Auto
	Offset-2 Sweep Time	Auto
	Offset-3 Sweep Time	Auto
	Offset-4 Sweep Time	Auto
	Offset-1 Auto Sweep Time Select	Fast
	Offset-2 Auto Sweep Time Select	Fast
	Offset-3 Auto Sweep Time Select	Fast
	Offset-4 Auto Sweep Time Select	Fast
Offset-1 Detection	Positive	
Offset-2 Detection	Positive	
Offset-3 Detection	Positive	
Offset-4 Detection	Positive	

Table C-5 Standard parameters for Spectrum Emission Mask (Cont'd)

Standard	Parameter Name	Setting
TELEC-T403 5290MHz Lower (WLAN)	Offset-1 Trace Point	1001
	Offset-2 Trace Point	1001
	Offset-3 Trace Point	1001
	Offset-4 Trace Point	1001
	Offset-1 Integrate BW	Auto
	Offset-2 Integrate BW	Auto
	Offset-3 Integrate BW	Auto
	Offset-4 Integrate BW	Auto
	Offset-1 On/Off	On
	Offset-2 On/Off	On
	Offset-3 On/Off	On
	Offset-4 On/Off	On
	Offset-5 On/Off	Off
	Limit-1 ABS1 Start Level	-6.02 dB
	Limit-2 ABS1 Start Level	-16.02 dB
	Limit-3 ABS1 Start Level	-23.98 dB
	Limit-4 ABS1 Start Level	-26.02 dB
	Limit-1 ABS1 Stop Level	-16.02 dB
	Limit-2 ABS1 Stop Level	-23.98 dB
	Limit-3 ABS1 Stop Level	-26.02 dB
	Limit-4 ABS1 Stop Level	-26.02 dB
	Limit-1 Fail Logic	ABS1
	Limit-2 Fail Logic	ABS1
	Limit-3 Fail Logic	ABS1
Limit-4 Fail Logic	ABS1	

Table C-5 Standard parameters for Spectrum Emission Mask (Cont'd)

Standard	Parameter Name	Setting
TELEC-T403 5290MHz Upper (WLAN)	Limit Side	Upper
	Reference Mode	Channel
	Channel BW	80 MHz
	RBW	1 MHz
	Sweep Time	Auto
	Auto Sweep Time Select	Fast
	Detection	Positive
	Trace Point	1001
	Filter Type	Rect
	Offset-1 Start Freq	60 MHz
	Offset-2 Start Freq	86.8 MHz
	Offset-1 Stop Freq	86.8 MHz
	Offset-2 Stop Freq	190 MHz
	Offset-1 Reference Level	Auto
	Offset-2 Reference Level	Auto
	Offset-1 RBW	1 MHz
	Offset-2 RBW	1 MHz
	Offset-1 Sweep Time	Auto
	Offset-2 Sweep Time	Auto
	Offset-1 Auto Sweep Time Select	Fast
	Offset-2 Auto Sweep Time Select	Fast
	Offset-1 Detection	Positive
	Offset-2 Detection	Positive
	Offset-1 Trace Point	1001
	Offset-2 Trace Point	1001
	Offset-1 Integrate BW	Auto
	Offset-2 Integrate BW	Auto
	Offset-1 On/Off	On
	Offset-2 On/Off	On
	Offset-3 On/Off	Off
	Limit-1 ABS1 Start Level	-18.24 dB
	Limit-2 ABS1 Start Level	-26.02 dB
	Limit-1 ABS1 Stop Level	-18.24 dB
Limit-2 ABS1 Stop Level	-26.02 dB	
Limit-1 Fail Logic	ABS1	
Limit-2 Fail Logic	ABS1	

Table C-5 Standard parameters for Spectrum Emission Mask (Cont'd)

Standard	Parameter Name	Setting
TELEC-T403 5250MHz Lower (WLAN)	Limit Side	Lower
	Reference Mode	Channel
	Channel BW	160 MHz
	RBW	1 MHz
	Sweep Time	Auto
	Auto Sweep Time Select	Fast
	Detection	Positive
	Trace Point	1001
	Filter Type	Rect
	Offset-1 Start Freq	100 MHz
	Offset-2 Start Freq	150.4 MHz
	Offset-1 Stop Freq	150.4 MHz
	Offset-2 Stop Freq	334 MHz
	Offset-1 Reference Level	Auto
	Offset-2 Reference Level	Auto
	Offset-1 RBW	1 MHz
	Offset-2 RBW	1 MHz
	Offset-1 Sweep Time	Auto
	Offset-2 Sweep Time	Auto
	Offset-1 Auto Sweep Time Select	Fast
	Offset-2 Auto Sweep Time Select	Fast
	Offset-1 Detection	Positive
	Offset-2 Detection	Positive
	Offset-1 Trace Point	1001
	Offset-2 Trace Point	1001
	Offset-1 Integrate BW	Auto
	Offset-2 Integrate BW	Auto
	Offset-1 On/Off	On
	Offset-2 On/Off	On
	Offset-3 On/Off	Off
	Limit-1 ABS1 Start Level	-18.24 dB
	Limit-2 ABS1 Start Level	-26.02 dB
	Limit-1 ABS1 Stop Level	-18.24 dB
Limit-2 ABS1 Stop Level	-26.02 dB	
Limit-1 Fail Logic	ABS1	
Limit-2 Fail Logic	ABS1	

Table C-5 Standard parameters for Spectrum Emission Mask (Cont'd)

Standard	Parameter Name	Setting
TELEC-T403 5250MHz Upper (WLAN)	Limit Side	Upper
	Reference Mode	Channel
	Channel BW	160 MHz
	RBW	1 MHz
	Sweep Time	Auto
	Auto Sweep Time Select	Fast
	Detection	Positive
	Trace Point	1001
	Filter Type	Rect
	Offset-1 Start Freq	100 MHz
	Offset-2 Start Freq	150.4 MHz
	Offset-1 Stop Freq	150.4 MHz
	Offset-2 Stop Freq	334 MHz
	Offset-1 Reference Level	Auto
	Offset-2 Reference Level	Auto
	Offset-1 RBW	1 MHz
	Offset-2 RBW	1 MHz
	Offset-1 Sweep Time	Auto
	Offset-2 Sweep Time	Auto
	Offset-1 Auto Sweep Time Select	Fast
	Offset-2 Auto Sweep Time Select	Fast
	Offset-1 Detection	Positive
	Offset-2 Detection	Positive
	Offset-1 Trace Point	1001
	Offset-2 Trace Point	1001
	Offset-1 Integrate BW	Auto
	Offset-2 Integrate BW	Auto
	Offset-1 On/Off	On
	Offset-2 On/Off	On
	Offset-3 On/Off	Off
	Limit-1 ABS1 Start Level	-18.24 dB
	Limit-2 ABS1 Start Level	-26.02 dB
	Limit-1 ABS1 Stop Level	-18.24 dB
Limit-2 ABS1 Stop Level	-26.02 dB	
Limit-1 Fail Logic	ABS1	
Limit-2 Fail Logic	ABS1	

Table C-5 Standard parameters for Spectrum Emission Mask (Cont'd)

Standard	Parameter Name	Setting
TELEC-T403 5210MHz 80+80 Lower (WLAN)	Limit Side	Lower
	Reference Mode	Channel
	Channel BW	80 MHz
	RBW	1 MHz
	Sweep Time	Auto
	Auto Sweep Time Select	Fast
	Detection	Positive
	Trace Point	1001
	Filter Type	Rect
	Offset-1 Start Freq	60 MHz
	Offset-2 Start Freq	75.2 MHz
	Offset-1 Stop Freq	75.2 MHz
	Offset-2 Stop Freq	190 MHz
	Offset-1 Reference Level	Auto
	Offset-2 Reference Level	Auto
	Offset-1 RBW	1 MHz
	Offset-2 RBW	1 MHz
	Offset-1 Sweep Time	Auto
	Offset-2 Sweep Time	Auto
	Offset-1 Auto Sweep Time Select	Fast
	Offset-2 Auto Sweep Time Select	Fast
	Offset-1 Detection	Positive
	Offset-2 Detection	Positive
	Offset-1 Trace Point	1001
	Offset-2 Trace Point	1001
	Offset-1 Integrate BW	Auto
	Offset-2 Integrate BW	Auto
	Offset-1 On/Off	On
	Offset-2 On/Off	On
	Offset-3 On/Off	Off
	Limit-1 ABS1 Start Level	-19.03 dB
	Limit-2 ABS1 Start Level	-26.02 dB
	Limit-1 ABS1 Stop Level	-19.03 dB
Limit-2 ABS1 Stop Level	-26.02 dB	
Limit-1 Fail Logic	ABS1	
Limit-2 Fail Logic	ABS1	

Table C-5 Standard parameters for Spectrum Emission Mask (Cont'd)

Standard	Parameter Name	Setting
TELEC-T403 5210MHz 80+80 Upper (WLAN)	Limit Side	Upper
	Reference Mode	Channel
	Channel BW	80 MHz
	RBW	1 MHz
	Sweep Time	Auto
	Auto Sweep Time Select	Fast
	Detection	Positive
	Trace Point	1001
	Filter Type	Rect
	Offset-1 Start Freq	40 MHz
	Offset-2 Start Freq	41 MHz
	Offset-3 Start Freq	75.2 MHz
	Offset-1 Stop Freq	41 MHz
	Offset-2 Stop Freq	75.2 MHz
	Offset-3 Stop Freq	160 MHz
	Offset-1 Reference Level	Auto
	Offset-2 Reference Level	Auto
	Offset-3 Reference Level	Auto
	Offset-1 RBW	1 MHz
	Offset-2 RBW	1 MHz
	Offset-3 RBW	1 MHz
	Offset-1 Sweep Time	Auto
	Offset-2 Sweep Time	Auto
	Offset-3 Sweep Time	Auto
	Offset-1 Auto Sweep Time Select	Fast
	Offset-2 Auto Sweep Time Select	Fast
	Offset-3 Auto Sweep Time Select	Fast
	Offset-1 Detection	Positive
	Offset-2 Detection	Positive
	Offset-3 Detection	Positive
	Offset-1 Trace Point	1001
Offset-2 Trace Point	1001	
Offset-3 Trace Point	1001	

Table C-5 Standard parameters for Spectrum Emission Mask (Cont'd)

Standard	Parameter Name	Setting
TELEC-T403 5210MHz 80+80 Upper (WLAN)	Offset-1 Integrate BW	Auto
	Offset-2 Integrate BW	Auto
	Offset-3 Integrate BW	Auto
	Offset-1 On/Off	On
	Offset-2 On/Off	On
	Offset-3 On/Off	On
	Offset-4 On/Off	Off
	Limit-1 ABS1 Start Level	-9.03 dB
	Limit-2 ABS1 Start Level	-19.03 dB
	Limit-3 ABS1 Start Level	-26.02 dB
	Limit-1 ABS1 Stop Level	-19.03 dB
	Limit-2 ABS1 Stop Level	-26.02 dB
	Limit-3 ABS1 Stop Level	-26.02 dB
	Limit-1 Fail Logic	ABS1
	Limit-2 Fail Logic	ABS1
	Limit-3 Fail Logic	ABS1

Table C-5 Standard parameters for Spectrum Emission Mask (Cont'd)

Standard	Parameter Name	Setting
TELEC-T403 5210MHz-5530M Hz Lower (WLAN)	Limit Side	Lower
	Reference Mode	Channel
	Channel BW	80 MHz
	RBW	1 MHz
	Sweep Time	Auto
	Auto Sweep Time Select	Fast
	Detection	Positive
	Trace Point	1001
	Filter Type	Rect
	Offset-1 Start Freq	60 MHz
	Offset-2 Start Freq	75.2 MHz
	Offset-1 Stop Freq	75.2 MHz
	Offset-2 Stop Freq	160 MHz
	Offset-1 Reference Level	Auto
	Offset-2 Reference Level	Auto
	Offset-1 RBW	1 MHz
	Offset-2 RBW	1 MHz
	Offset-1 Sweep Time	Auto
	Offset-2 Sweep Time	Auto
	Offset-1 Auto Sweep Time Select	Fast
	Offset-2 Auto Sweep Time Select	Fast
	Offset-1 Detection	Positive
	Offset-2 Detection	Positive
	Offset-1 Trace Point	1001
	Offset-2 Trace Point	1001
	Offset-1 Integrate BW	Auto
	Offset-2 Integrate BW	Auto
	Offset-1 On/Off	On
	Offset-2 On/Off	On
	Offset-3 On/Off	Off
	Limit-1 ABS1 Start Level	-18.24 dB
	Limit-2 ABS1 Start Level	-26.02 dB
	Limit-1 ABS1 Stop Level	-18.24 dB
Limit-2 ABS1 Stop Level	-26.02 dB	
Limit-1 Fail Logic	ABS1	
Limit-2 Fail Logic	ABS1	

Table C-5 Standard parameters for Spectrum Emission Mask (Cont'd)

Standard	Parameter Name	Setting
TELEC-T403 5210MHz-5610M Hz Upper (WLAN)	Limit Side	Upper
	Reference Mode	Channel
	Channel BW	80 MHz
	RBW	1 MHz
	Sweep Time	Auto
	Auto Sweep Time Select	Fast
	Detection	Positive
	Trace Point	1001
	Filter Type	Rect
	Offset-1 Start Freq	115 MHz
	Offset-1 Stop Freq	190 MHz
	Offset-1 Reference Level	Auto
	Offset-1 RBW	1 MHz
	Offset-1 Sweep Time	Auto
	Offset-1 Auto Sweep Time Select	Fast
	Offset-1 Detection	Positive
	Offset-1 Trace Point	1001
	Offset-1 Integrate BW	Auto
	Offset-1 On/Off	On
	Offset-2 On/Off	Off
	Limit-1 ABS1 Start Level	-18.24 dB
Limit-1 ABS1 Stop Level	-18.24 dB	
Limit-1 Fail Logic	ABS1	

Table C-5 Standard parameters for Spectrum Emission Mask (Cont'd)

Standard	Parameter Name	Setting
TELEC-T403 5290MHz 80+80 Lower (WLAN)	Limit Side	Lower
	Reference Mode	Channel
	Channel BW	80 MHz
	RBW	1 MHz
	Sweep Time	Auto
	Auto Sweep Time Select	Fast
	Detection	Positive
	Trace Point	1001
	Filter Type	Rect
	Offset-1 Start Freq	40 MHz
	Offset-2 Start Freq	41 MHz
	Offset-3 Start Freq	75.2 MHz
	Offset-1 Stop Freq	41 MHz
	Offset-2 Stop Freq	75.2 MHz
	Offset-3 Stop Freq	270 MHz
	Offset-1 Reference Level	Auto
	Offset-2 Reference Level	Auto
	Offset-3 Reference Level	Auto
	Offset-1 RBW	1 MHz
	Offset-2 RBW	1 MHz
	Offset-3 RBW	1 MHz
	Offset-1 Sweep Time	Auto
	Offset-2 Sweep Time	Auto
	Offset-3 Sweep Time	Auto
	Offset-1 Auto Sweep Time Select	Fast
	Offset-2 Auto Sweep Time Select	Fast
	Offset-3 Auto Sweep Time Select	Fast
	Offset-1 Detection	Positive
	Offset-2 Detection	Positive
	Offset-3 Detection	Positive
	Offset-1 Trace Point	1001
	Offset-2 Trace Point	1001
Offset-3 Trace Point	1001	

Table C-5 Standard parameters for Spectrum Emission Mask (Cont'd)

Standard	Parameter Name	Setting
TELEC-T403 5290MHz 80+80 Lower (WLAN)	Offset-1 Integrate BW	Auto
	Offset-2 Integrate BW	Auto
	Offset-3 Integrate BW	Auto
	Offset-1 On/Off	On
	Offset-2 On/Off	On
	Offset-3 On/Off	On
	Offset-4 On/Off	Off
	Limit-1 ABS1 Start Level	-9.03 dB
	Limit-2 ABS1 Start Level	-19.03 dB
	Limit-3 ABS1 Start Level	-26.02 dB
	Limit-1 ABS1 Stop Level	-19.03 dB
	Limit-2 ABS1 Stop Level	-26.02 dB
	Limit-3 ABS1 Stop Level	-26.02 dB
	Limit-1 Fail Logic	ABS1
	Limit-2 Fail Logic	ABS1
	Limit-3 Fail Logic	ABS1

Table C-5 Standard parameters for Spectrum Emission Mask (Cont'd)

Standard	Parameter Name	Setting
TELEC-T403 5290MHz 80+80 Upper (WLAN)	Limit Side	Upper
	Reference Mode	Channel
	Channel BW	80 MHz
	RBW	1 MHz
	Sweep Time	Auto
	Auto Sweep Time Select	Fast
	Detection	Positive
	Trace Point	1001
	Filter Type	Rect
	Offset-1 Start Freq	60 MHz
	Offset-2 Start Freq	75.2 MHz
	Offset-1 Stop Freq	75.2 MHz
	Offset-2 Stop Freq	120 MHz
	Offset-1 Reference Level	Auto
	Offset-2 Reference Level	Auto
	Offset-1 RBW	1 MHz
	Offset-2 RBW	1 MHz
	Offset-1 Sweep Time	Auto
	Offset-2 Sweep Time	Auto
	Offset-1 Auto Sweep Time Select	Fast
	Offset-2 Auto Sweep Time Select	Fast
	Offset-1 Detection	Positive
	Offset-2 Detection	Positive
	Offset-1 Trace Point	1001
	Offset-2 Trace Point	1001
	Offset-1 Integrate BW	Auto
	Offset-2 Integrate BW	Auto
	Offset-1 On/Off	On
	Offset-2 On/Off	On
	Offset-3 On/Off	Off
	Limit-1 ABS1 Start Level	-18.24 dB
	Limit-2 ABS1 Start Level	-26.02 dB
	Limit-1 ABS1 Stop Level	-18.24 dB
	Limit-2 ABS1 Stop Level	-26.02 dB
Limit-1 Fail Logic	ABS1	
Limit-2 Fail Logic	ABS1	

Table C-5 Standard parameters for Spectrum Emission Mask (Cont'd)

Standard	Parameter Name	Setting
TELEC-T403 5290MHz-5530M Hz Lower (WLAN)	Limit Side	Lower
	Reference Mode	Channel
	Channel BW	80 MHz
	RBW	1 MHz
	Sweep Time	Auto
	Auto Sweep Time Select	Fast
	Detection	Positive
	Trace Point	1001
	Filter Type	Rect
	Offset-1 Start Freq	60 MHz
	Offset-2 Start Freq	75.2 MHz
	Offset-1 Stop Freq	75.2 MHz
	Offset-2 Stop Freq	120 MHz
	Offset-1 Reference Level	Auto
	Offset-2 Reference Level	Auto
	Offset-1 RBW	1 MHz
	Offset-2 RBW	1 MHz
	Offset-1 Sweep Time	Auto
	Offset-2 Sweep Time	Auto
	Offset-1 Auto Sweep Time Select	Fast
	Offset-2 Auto Sweep Time Select	Fast
	Offset-1 Detection	Positive
	Offset-2 Detection	Positive
	Offset-1 Trace Point	1001
	Offset-2 Trace Point	1001
	Offset-1 Integrate BW	Auto
	Offset-2 Integrate BW	Auto
	Offset-1 On/Off	On
	Offset-2 On/Off	On
	Offset-3 On/Off	Off
	Limit-1 ABS1 Start Level	-18.24 dB
	Limit-2 ABS1 Start Level	-26.02 dB
	Limit-1 ABS1 Stop Level	-18.24 dB
Limit-2 ABS1 Stop Level	-26.02 dB	
Limit-1 Fail Logic	ABS1	
Limit-2 Fail Logic	ABS1	

Table C-5 Standard parameters for Spectrum Emission Mask (Cont'd)

Standard	Parameter Name	Setting
TELEC-T403 5290MHz-5610M Hz Upper (WLAN)	Limit Side	Upper
	Reference Mode	Channel
	Channel BW	80 MHz
	RBW	1 MHz
	Sweep Time	Auto
	Auto Sweep Time Select	Fast
	Detection	Positive
	Trace Point	1001
	Filter Type	Rect
	Offset-1 Start Freq	115 MHz
	Offset-1 Stop Freq	190 MHz
	Offset-1 Reference Level	Auto
	Offset-1 RBW	1 MHz
	Offset-1 Sweep Time	Auto
	Offset-1 Auto Sweep Time Select	Fast
	Offset-1 Detection	Positive
	Offset-1 Trace Point	1001
	Offset-1 Integrate BW	Auto
	Offset-1 On/Off	On
	Offset-2 On/Off	Off
	Limit-1 ABS1 Start Level	-18.24 dB
Limit-1 ABS1 Stop Level	-18.24 dB	
Limit-1 Fail Logic	ABS1	

NXDN

Table C-5 Standard parameters for Spectrum Emission Mask (Cont'd)

Standard	Parameter Name	Setting
NXDN 47CFR-E_6.25k Hz	Limit Side	Both
	Reference Mode	Peak
	Channel BW	6 kHz
	RBW	30 kHz
	VBW	30 kHz
	VBW Mode	Power
	Sweep Time	Manual
	Sweep Time Value	3 sec
	Auto Sweep Time Select	Normal
	Detection	Positive
	Trace Point	1001
	Offset-1 Start Freq	0 Hz
	Offset-2 Start Freq	3 kHz
	Offset-3 Start Freq	4.6 kHz
	Offset-1 Stop Freq	3 kHz
	Offset-2 Stop Freq	4.6 kHz
	Offset-3 Stop Freq	50 kHz
	Offset-1 RBW	100 Hz
	Offset-2 RBW	100 Hz
	Offset-3 RBW	100 Hz
	Offset-1 VBW	1 kHz
	Offset-2 VBW	1 kHz
	Offset-3 VBW	1 kHz
	Offset-1 VBW Mode	Power
	Offset-2 VBW Mode	Power
Offset-3 VBW Mode	Power	

Table C-5 Standard parameters for Spectrum Emission Mask (Cont'd)

Standard	Parameter Name	Setting
NXDN 47CFR-E_6.25k Hz	Offset-1 Sweep Time Switch	Manual
	Offset-1 Sweep Time Value	2.9 sec
	Offset-2 Sweep Time Switch	Manual
	Offset-2 Sweep Time Value	3.5 sec
	Offset-3 Sweep Time Switch	Manual
	Offset-3 Sweep Time Value	6.3 sec
	Offset-1 Auto Sweep Time Select	Normal
	Offset-2 Auto Sweep Time Select	Normal
	Offset-3 Auto Sweep Time Select	Normal
	Offset-1 Detection	Positive
	Offset-2 Detection	Positive
	Offset-3 Detection	Positive
	Offset-1 Trace Point	1001
	Offset-2 Trace Point	1001
	Offset-3 Trace Point	1001
	Offset-1 On/Off	On
	Offset-2 On/Off	On
	Offset-3 On/Off	On
	Offset-4 On/Off	Off
	Offset-5 On/Off	Off
	Offset-6 On/Off	Off
	Offset-7 On/Off	Off
	Offset-8 On/Off	Off
	Offset-9 On/Off	Off
	Offset-10 On/Off	Off
	Offset-11 On/Off	Off
	Offset-12 On/Off	Off
	Limit-1 REL Start Level	0.0 dB
	Limit-2 REL Start Level	-30.0 dB
	Limit-3 REL Start Level	-65.0 dB
	Limit-1 REL Stop Level	0.0 dB
	Limit-2 REL Stop Level	-56.67 dB
	Limit-3 REL Stop Level	-65.0 dB
Limit-1 Fail Logic	REL	
Limit-2 Fail Logic	REL	
Limit-3 Fail Logic	REL	

Table C-5 Standard parameters for Spectrum Emission Mask (Cont'd)

Standard	Parameter Name	Setting
NXDN 47CFR-D_12.5k Hz	Limit Side	Both
	Reference Mode	Peak
	Channel BW	11.25 kHz
	RBW	30 kHz
	VBW	30 kHz
	VBW Mode	Power
	Sweep Time	Manual
	Sweep Time Value	5.7 sec
	Auto Sweep Time Select	Normal
	Detection	Positive
	Trace Point	1001
	Offset-1 Start Freq	0 Hz
	Offset-2 Start Freq	5.624 kHz
	Offset-3 Start Freq	12.5 kHz
	Offset-1 Stop Freq	5.624 kHz
	Offset-2 Stop Freq	12.5 kHz
	Offset-3 Stop Freq	50 kHz
	Offset-1 RBW	100 Hz
	Offset-2 RBW	100 Hz
	Offset-3 RBW	100 Hz
	Offset-1 VBW	1 kHz
	Offset-2 VBW	1 kHz
	Offset-3 VBW	1 kHz
	Offset-1 VBW Mode	Power
	Offset-2 VBW Mode	Power
	Offset-3 VBW Mode	Power

Table C-5 Standard parameters for Spectrum Emission Mask (Cont'd)

Standard	Parameter Name	Setting
NXDN 47CFR-D_12.5k Hz	Offset-1 Sweep Time Switch	Manual
	Offset-1 Sweep Time Value	2.9 sec
	Offset-2 Sweep Time Switch	Manual
	Offset-2 Sweep Time Value	3.5 sec
	Offset-3 Sweep Time Switch	Manual
	Offset-3 Sweep Time Value	6.3 sec
	Offset-1 Detection	Positive
	Offset-2 Detection	Positive
	Offset-3 Detection	Positive
	Offset-1 Trace Point	1001
	Offset-2 Trace Point	1001
	Offset-3 Trace Point	1001
	Offset-1 On/Off	On
	Offset-2 On/Off	On
	Offset-3 On/Off	On
	Offset-4 On/Off	Off
	Offset-5 On/Off	Off
	Offset-6 On/Off	Off
	Offset-7 On/Off	Off
	Offset-8 On/Off	Off
	Offset-9 On/Off	Off
	Offset-10 On/Off	Off
	Offset-11 On/Off	Off
	Offset-12 On/Off	Off
	Limit-1 REL Start Level	0.0 dB
	Limit-2 REL Start Level	-19.95 dB
	Limit-3 REL Start Level	-70.0 dB
	Limit-1 REL Stop Level	0.0 dB
	Limit-2 REL Stop Level	-69.94 dB
	Limit-3 REL Stop Level	-70.0 dB
	Limit-1 Fail Logic	REL
Limit-2 Fail Logic	REL	
Limit-3 Fail Logic	REL	

C-6 Spurious Emission

TELEC-T401

Table C-6 Standard parameters for Spurious Emission

Standard	Parameter Name	Setting
TELEC-T401 (WLAN)	Spurious Result Type	Worst
	Spurious Fail Stop	Off
	Spurious Segment Switch1	On
	Spurious Segment Switch2	On
	Spurious Segment Switch3	On
	Spurious Segment Switch4	On
	Spurious Segment Switch5	On
	Spurious Segment Switch6	On
	Spurious Segment Switch7	On
	Spurious Segment Switch8	On
	Segment-1 Start Freq	30 MHz
	Segment-1 Stop Freq	2.387 GHz
	Segment-1 RBW	1 MHz
	Segment-1 VBW	1 MHz
	Segment-1 Sweep Time Switch	Auto
	Segment-1 Detection	Positive
	Segment-1 Limit Start Level	-26 dB
	Segment-1 Limit Stop Level	-26 dB
	Segment-2 Start Freq	2.387 GHz
	Segment-2 Stop Freq	2.4000 GHz
	Segment-2 RBW	1 MHz
	Segment-2 VBW	1 MHz
	Segment-2 Sweep Time Switch	Auto
	Segment-2 Detection	Positive
	Segment-2 Limit Start Level	-16 dB
	Segment-2 Limit Stop Level	-16 dB
	Segment-3 Start Freq	2.4835 GHz
	Segment-3 Stop Freq	2.4965 GHz
	Segment-3 RBW	1 MHz
	Segment-3 VBW	1 MHz
Segment-3 Sweep Time Switch	Auto	
Segment-3 Detection	Positive	
Segment-3 Limit Start Level	-16 dB	
Segment-3 Limit Stop Level	-16 dB	

Table C-6 Standard parameters for Spurious Emission (Cont'd)

Standard	Parameter Name	Setting
TELEC-T401 (WLAN)	Segment-4 Start Freq	2.4965 GHz
	Segment-4 Stop Freq	12.5 GHz or Max Frequency
	Segment-4 RBW	1 MHz
	Segment-4 VBW	1 MHz
	Segment-4 Sweep Time Switch	Auto
	Segment-4 Detection	Positive
	Segment-4 Limit Start Level	-26 dB
	Segment-4 Limit Stop Level	-26 dB
	Segment-5 Start Freq	2.374 GHz
	Segment-5 Stop Freq	2.387 GHz
	Segment-5 RBW	1 MHz
	Segment-5 VBW	1 MHz
	Segment-5 Sweep Time Switch	Auto
	Segment-5 Detection	Positive
	Segment-5 Limit Start Level	-26 dB
	Segment-5 Limit Stop Level	-26 dB
	Segment-6 Start Freq	2.387 GHz
	Segment-6 Stop Freq	2.400 GHz
	Segment-6 RBW	1 MHz
	Segment-6 VBW	1 MHz
	Segment-6 Sweep Time Switch	Auto
	Segment-6 Detection	Positive
	Segment-6 Limit Start Level	-16 dB
	Segment-6 Limit Stop Level	-16 dB
	Segment-7 Start Freq	2.4835 GHz
	Segment-7 Stop Freq	2.4965 GHz
	Segment-7 RBW	1 MHz
	Segment-7 VBW	1 MHz
Segment-7 Sweep Time Switch	Auto	
Segment-7 Detection	Positive	
Segment-7 Limit Start Level	-16 dB	
Segment-7 Limit Stop Level	-16 dB	

Table C-6 Standard parameters for Spurious Emission (Cont'd)

Standard	Parameter Name	Setting
TELEC-T401 (WLAN)	Segment-8 Start Freq	2.4965 GHz
	Segment-8 Stop Freq	2.5095 GHz
	Segment-8 RBW	1 MHz
	Segment-8 VBW	1 MHz
	Segment-8 Sweep Time Switch	Auto
	Segment-8 Detection	Positive
	Segment-8 Limit Start Level	-26 dB
	Segment-8 Limit Stop Level	-26 dB

TELEC-T402

Table C-6 Standard parameters for Spurious Emission (Cont'd)

Standard	Parameter Name	Setting
TELEC-T402 (WLAN)	Spurious Result Type	Worst
	Spurious Fail Stop	Off
	Spurious Segment Switch1	On
	Spurious Segment Switch2	On
	Spurious Segment Switch3	On
	Spurious Segment Switch4	On
	Spurious Segment Switch5	On
	Spurious Segment Switch6	On
	Spurious Segment Switch7	On
	Spurious Segment Switch8	On
	Segment-1 Start Freq	30 MHz
	Segment-1 Stop Freq	2.458 GHz
	Segment-1 RBW	1 MHz
	Segment-1 VBW	1 MHz
	Segment-1 Sweep Time Switch	Auto
	Segment-1 Detection	Positive
	Segment-1 Limit Start Level	-26 dB
	Segment-1 Limit Stop Level	-26 dB
	Segment-2 Start Freq	2.458 GHz
	Segment-2 Stop Freq	2.471 GHz
	Segment-2 RBW	1 MHz
	Segment-2 VBW	1 MHz
	Segment-2 Sweep Time Switch	Auto
	Segment-2 Detection	Positive
	Segment-2 Limit Start Level	-16 dB
	Segment-2 Limit Stop Level	-16 dB
	Segment-3 Start Freq	2.497 GHz
	Segment-3 Stop Freq	2.510 GHz
	Segment-3 RBW	1 MHz
	Segment-3 VBW	1 MHz
	Segment-3 Sweep Time Switch	Auto
	Segment-3 Detection	Positive
Segment-3 Limit Start Level	-16 dB	
Segment-3 Limit Stop Level	-16 dB	
Segment-4 Start Freq	2.510 GHz	
Segment-4 Stop Freq	12.5 GHz or Max Frequency	

Table C-6 Standard parameters for Spurious Emission (Cont'd)

Standard	Parameter Name	Setting
TELEC-T402 (WLAN)	Segment-4 RBW	1 MHz
	Segment-4 VBW	1 MHz
	Segment-4 Sweep Time Switch	Auto
	Segment-4 Detection	Positive
	Segment-4 Limit Start Level	-26 dB
	Segment-4 Limit Stop Level	-26 dB
	Segment-5 Start Freq	2.450 GHz
	Segment-5 Stop Freq	2.458 GHz
	Segment-5 RBW	1 MHz
	Segment-5 VBW	1 MHz
	Segment-5 Sweep Time Switch	Auto
	Segment-5 Detection	Positive
	Segment-5 Limit Start Level	-26 dB
	Segment-5 Limit Stop Level	-26 dB
	Segment-6 Start Freq	2.458 GHz
	Segment-6 Stop Freq	2.471 GHz
	Segment-6 RBW	1 MHz
	Segment-6 VBW	1 MHz
	Segment-6 Sweep Time Switch	Auto
	Segment-6 Detection	Positive
	Segment-6 Limit Start Level	-16 dB
	Segment-6 Limit Stop Level	-16 dB
	Segment-7 Start Freq	2.497 GHz
	Segment-7 Stop Freq	2.510 GHz
	Segment-7 RBW	1 MHz
	Segment-7 VBW	1 MHz
	Segment-7 Sweep Time Switch	Auto
	Segment-7 Detection	Positive
	Segment-7 Limit Start Level	-16 dB
	Segment-7 Limit Stop Level	-16 dB
	Segment-8 Start Freq	2.510 GHz
	Segment-8 Stop Freq	2.523 GHz
Segment-8 RBW	1 MHz	
Segment-8 VBW	1 MHz	
Segment-8 Sweep Time Switch	Auto	
Segment-8 Detection	Positive	
Segment-8 Limit Start Level	-26 dB	
Segment-8 Limit Stop Level	-26 dB	

TELEC-T403

Table C-6 Standard parameters for Spurious Emission (Cont'd)

Standard	Parameter Name	Setting
TELEC-T403 ≤ 18MHz 5.2GHz (WLAN)	Spurious Result Type	Worst
	Spurious Fail Stop	Off
	Spurious Segment Switch1	On
	Spurious Segment Switch2	On
	Spurious Segment Switch3	Off
	Segment-1 Start Freq	30 MHz
	Segment-1 Stop Freq	5.14 GHz
	Segment-1 RBW	1 MHz
	Segment-1 VBW	1 MHz
	Segment-1 Sweep Time Switch	Auto
	Segment-1 Detection	Positive
	Segment-1 Limit Start Level	-26 dB
	Segment-1 Limit Stop Level	-26 dB
	Segment-2 Start Freq	5.360 GHz
	Segment-2 Stop Freq	26 GHz or Max Frequency
	Segment-2 RBW	1 MHz
	Segment-2 VBW	1 MHz
	Segment-2 Sweep Time Switch	Auto
	Segment-2 Detection	Positive
	Segment-2 Limit Start Level	-26 dB
Segment-2 Limit Stop Level	-26 dB	

Table C-6 Standard parameters for Spurious Emission (Cont'd)

Standard	Parameter Name	Setting
TELEC-T403 ≤ 18MHz 5.3GHz (WLAN)	Spurious Result Type	Worst
	Spurious Fail Stop	Off
	Spurious Segment Switch1	On
	Spurious Segment Switch2	On
	Spurious Segment Switch3	Off
	Segment-1 Start Freq	30 MHz
	Segment-1 Stop Freq	5.14 GHz
	Segment-1 RBW	1 MHz
	Segment-1 VBW	1 MHz
	Segment-1 Sweep Time Switch	Auto
	Segment-1 Detection	Positive
	Segment-1 Limit Start Level	-26 dB
	Segment-1 Limit Stop Level	-26 dB
	Segment-2 Start Freq	5.360 GHz
	Segment-2 Stop Freq	26 GHz or Max Frequency
	Segment-2 RBW	1 MHz
	Segment-2 VBW	1 MHz
	Segment-2 Sweep Time Switch	Auto
	Segment-2 Detection	Positive
	Segment-2 Limit Start Level	-26 dB
Segment-2 Limit Stop Level	-26 dB	

Table C-6 Standard parameters for Spurious Emission (Cont'd)

Standard	Parameter Name	Setting
TELEC-T403 ≤ 18MHz 5.6GHz (WLAN)	Spurious Result Type	Worst
	Spurious Fail Stop	Off
	Spurious Segment Switch1	On
	Spurious Segment Switch2	On
	Spurious Segment Switch3	Off
	Segment-1 Start Freq	30 MHz
	Segment-1 Stop Freq	5.46 GHz
	Segment-1 RBW	1 MHz
	Segment-1 VBW	1 MHz
	Segment-1 Sweep Time Switch	Auto
	Segment-1 Detection	Positive
	Segment-1 Limit Start Level	-26 dB
	Segment-1 Limit Stop Level	-26 dB
	Segment-2 Start Freq	5.74 GHz
	Segment-2 Stop Freq	26 GHz or Max Frequency
	Segment-2 RBW	1 MHz
	Segment-2 VBW	1 MHz
	Segment-2 Sweep Time Switch	Auto
	Segment-2 Detection	Positive
	Segment-2 Limit Start Level	-26 dB
Segment-2 Limit Stop Level	-26 dB	

Table C-6 Standard parameters for Spurious Emission (Cont'd)

Standard	Parameter Name	Setting
TELEC-T403 18MHz <, ≤ 19MHz 5.2GHz (WLAN)	Spurious Result Type	Worst
	Spurious Fail Stop	Off
	Spurious Segment Switch1	On
	Spurious Segment Switch2	On
	Spurious Segment Switch3	Off
	Segment-1 Start Freq	30 MHz
	Segment-1 Stop Freq	5.135 GHz
	Segment-1 RBW	1 MHz
	Segment-1 VBW	1 MHz
	Segment-1 Sweep Time Switch	Auto
	Segment-1 Detection	Positive
	Segment-1 Limit Start Level	-26 dB
	Segment-1 Limit Stop Level	-26 dB
	Segment-2 Start Freq	5.365 GHz
	Segment-2 Stop Freq	26 GHz or Max Frequency
	Segment-2 RBW	1 MHz
	Segment-2 VBW	1 MHz
	Segment-2 Sweep Time Switch	Auto
	Segment-2 Detection	Positive
	Segment-2 Limit Start Level	-26 dB
Segment-2 Limit Stop Level	-26 dB	

Table C-6 Standard parameters for Spurious Emission (Cont'd)

Standard	Parameter Name	Setting
TELEC-T403 18MHz < ≤ 19MHz 5.3GHz (WLAN)	Spurious Result Type	Worst
	Spurious Fail Stop	Off
	Spurious Segment Switch1	On
	Spurious Segment Switch2	On
	Spurious Segment Switch3	Off
	Segment-1 Start Freq	30 MHz
	Segment-1 Stop Freq	5.135 GHz
	Segment-1 RBW	1 MHz
	Segment-1 VBW	1 MHz
	Segment-1 Sweep Time Switch	Auto
	Segment-1 Detection	Positive
	Segment-1 Limit Start Level	-26 dB
	Segment-1 Limit Stop Level	-26 dB
	Segment-2 Start Freq	5.365 GHz
	Segment-2 Stop Freq	26 GHz or Max Frequency
	Segment-2 RBW	1 MHz
	Segment-2 VBW	1 MHz
	Segment-2 Sweep Time Switch	Auto
	Segment-2 Detection	Positive
	Segment-2 Limit Start Level	-26 dB
Segment-2 Limit Stop Level	-26 dB	

Table C-6 Standard parameters for Spurious Emission (Cont'd)

Standard	Parameter Name	Setting
TELEC-T403 18MHz <, ≤ 19MHz 5.6GHz (WLAN)	Spurious Result Type	Worst
	Spurious Fail Stop	Off
	Spurious Segment Switch1	On
	Spurious Segment Switch2	On
	Spurious Segment Switch3	Off
	Segment-1 Start Freq	30 MHz
	Segment-1 Stop Freq	5.455 GHz
	Segment-1 RBW	1 MHz
	Segment-1 VBW	1 MHz
	Segment-1 Sweep Time Switch	Auto
	Segment-1 Detection	Positive
	Segment-1 Limit Start Level	-26 dB
	Segment-1 Limit Stop Level	-26 dB
	Segment-2 Start Freq	5.745 GHz
	Segment-2 Stop Freq	26 GHz or Max Frequency
	Segment-2 RBW	1 MHz
	Segment-2 VBW	1 MHz
	Segment-2 Sweep Time Switch	Auto
	Segment-2 Detection	Positive
	Segment-2 Limit Start Level	-26 dB
Segment-2 Limit Stop Level	-26 dB	

Table C-6 Standard parameters for Spurious Emission (Cont'd)

Standard	Parameter Name	Setting
TELEC-T403 19MHz < 5.2GHz (WLAN)	Spurious Result Type	Worst
	Spurious Fail Stop	Off
	Spurious Segment Switch1	On
	Spurious Segment Switch2	On
	Spurious Segment Switch3	Off
	Segment-1 Start Freq	30 MHz
	Segment-1 Stop Freq	5.1 GHz
	Segment-1 RBW	1 MHz
	Segment-1 VBW	1 MHz
	Segment-1 Sweep Time Switch	Auto
	Segment-1 Detection	Positive
	Segment-1 Limit Start Level	-26 dB
	Segment-1 Limit Stop Level	-26 dB
	Segment-2 Start Freq	5.4 GHz
	Segment-2 Stop Freq	26 GHz or Max Frequency
	Segment-2 RBW	1 MHz
	Segment-2 VBW	1 MHz
	Segment-2 Sweep Time Switch	Auto
	Segment-2 Detection	Positive
	Segment-2 Limit Start Level	-26 dB
Segment-2 Limit Stop Level	-26 dB	

Table C-6 Standard parameters for Spurious Emission (Cont'd)

Standard	Parameter Name	Setting
TELEC-T403 19MHz < 5.3GHz (WLAN)	Spurious Result Type	Worst
	Spurious Fail Stop	Off
	Spurious Segment Switch1	On
	Spurious Segment Switch2	On
	Spurious Segment Switch3	Off
	Segment-1 Start Freq	30 MHz
	Segment-1 Stop Freq	5.1 GHz
	Segment-1 RBW	1 MHz
	Segment-1 VBW	1 MHz
	Segment-1 Sweep Time Switch	Auto
	Segment-1 Detection	Positive
	Segment-1 Limit Start Level	-26 dB
	Segment-1 Limit Stop Level	-26 dB
	Segment-2 Start Freq	5.4 GHz
	Segment-2 Stop Freq	26 GHz or Max Frequency
	Segment-2 RBW	1 MHz
	Segment-2 VBW	1 MHz
	Segment-2 Sweep Time Switch	Auto
	Segment-2 Detection	Positive
	Segment-2 Limit Start Level	-26 dB
Segment-2 Limit Stop Level	-26 dB	

Table C-6 Standard parameters for Spurious Emission (Cont'd)

Standard	Parameter Name	Setting
TELEC-T403 19MHz < 5.6GHz (WLAN)	Spurious Result Type	Worst
	Spurious Fail Stop	Off
	Spurious Segment Switch1	On
	Spurious Segment Switch2	On
	Spurious Segment Switch3	Off
	Segment-1 Start Freq	30 MHz
	Segment-1 Stop Freq	5.42 GHz
	Segment-1 RBW	1 MHz
	Segment-1 VBW	1 MHz
	Segment-1 Sweep Time Switch	Auto
	Segment-1 Detection	Positive
	Segment-1 Limit Start Level	-26 dB
	Segment-1 Limit Stop Level	-26 dB
	Segment-2 Start Freq	5.76 GHz
	Segment-2 Stop Freq	26 GHz or Max Frequency
	Segment-2 RBW	1 MHz
	Segment-2 VBW	1 MHz
	Segment-2 Sweep Time Switch	Auto
	Segment-2 Detection	Positive
	Segment-2 Limit Start Level	-26 dB
Segment-2 Limit Stop Level	-26 dB	

Table C-6 Standard parameters for Spurious Emission (Cont'd)

Standard	Parameter Name	Setting
TELEC-T403 38MHz < , ≤78MHz 5.2GHz (WLAN)	Spurious Result Type	Worst
	Spurious Fail Stop	Off
	Spurious Segment Switch1	On
	Spurious Segment Switch2	On
	Spurious Segment Switch3	Off
	Segment-1 Start Freq	30 MHz
	Segment-1 Stop Freq	5.020 GHz
	Segment-1 RBW	1 MHz
	Segment-1 VBW	1 MHz
	Segment-1 Sweep Time Switch	Auto
	Segment-1 Detection	Positive
	Segment-1 Limit Start Level	-26 dB
	Segment-1 Limit Stop Level	-26 dB
	Segment-2 Start Freq	5.480 GHz
	Segment-2 Stop Freq	26 GHz or Max Frequency
	Segment-2 RBW	1 MHz
	Segment-2 VBW	1 MHz
	Segment-2 Sweep Time Switch	Auto
	Segment-2 Detection	Positive
	Segment-2 Limit Start Level	-26 dB
Segment-2 Limit Stop Level	-26 dB	

Table C-6 Standard parameters for Spurious Emission (Cont'd)

Standard	Parameter Name	Setting
TELEC-T403 38MHz < , ≤78MHz 5.3GHz (WLAN)	Spurious Result Type	Worst
	Spurious Fail Stop	Off
	Spurious Segment Switch1	On
	Spurious Segment Switch2	On
	Spurious Segment Switch3	Off
	Segment-1 Start Freq	30 MHz
	Segment-1 Stop Freq	5.020 GHz
	Segment-1 RBW	1 MHz
	Segment-1 VBW	1 MHz
	Segment-1 Sweep Time Switch	Auto
	Segment-1 Detection	Positive
	Segment-1 Limit Start Level	-26 dB
	Segment-1 Limit Stop Level	-26 dB
	Segment-2 Start Freq	5.480 GHz
	Segment-2 Stop Freq	26 GHz or Max Frequency
	Segment-2 RBW	1 MHz
	Segment-2 VBW	1 MHz
	Segment-2 Sweep Time Switch	Auto
	Segment-2 Detection	Positive
	Segment-2 Limit Start Level	-26 dB
Segment-2 Limit Stop Level	-26 dB	

Table C-6 Standard parameters for Spurious Emission (Cont'd)

Standard	Parameter Name	Setting
TELEC-T403 38MHz < , ≤78MHz 5.6GHz (WLAN)	Spurious Result Type	Worst
	Spurious Fail Stop	Off
	Spurious Segment Switch1	On
	Spurious Segment Switch2	On
	Spurious Segment Switch3	Off
	Segment-1 Start Freq	30 MHz
	Segment-1 Stop Freq	5.340 GHz
	Segment-1 RBW	1 MHz
	Segment-1 VBW	1 MHz
	Segment-1 Sweep Time Switch	Auto
	Segment-1 Detection	Positive
	Segment-1 Limit Start Level	-26 dB
	Segment-1 Limit Stop Level	-26 dB
	Segment-2 Start Freq	5.800 GHz
	Segment-2 Stop Freq	26 GHz or Max Frequency
	Segment-2 RBW	1 MHz
	Segment-2 VBW	1 MHz
	Segment-2 Sweep Time Switch	Auto
	Segment-2 Detection	Positive
	Segment-2 Limit Start Level	-26 dB
Segment-2 Limit Stop Level	-26 dB	

Table C-6 Standard parameters for Spurious Emission (Cont'd)

Standard	Parameter Name	Setting
TELEC-T403 78MHz < 5.2GHz 5.3GHz (WLAN)	Spurious Result Type	Worst
	Spurious Fail Stop	Off
	Spurious Segment Switch1	On
	Spurious Segment Switch2	On
	Spurious Segment Switch3	Off
	Segment-1 Start Freq	30 MHz
	Segment-1 Stop Freq	4.916 GHz
	Segment-1 RBW	1 MHz
	Segment-1 VBW	1 MHz
	Segment-1 Sweep Time Switch	Auto
	Segment-1 Detection	Positive
	Segment-1 Limit Start Level	-26 dB
	Segment-1 Limit Stop Level	-26 dB
	Segment-2 Start Freq	5.584 GHz
	Segment-2 Stop Freq	26 GHz or Max Frequency
	Segment-2 RBW	1 MHz
	Segment-2 VBW	1 MHz
	Segment-2 Sweep Time Switch	Auto
	Segment-2 Detection	Positive
	Segment-2 Limit Start Level	-26 dB
Segment-2 Limit Stop Level	-26 dB	

Table C-6 Standard parameters for Spurious Emission (Cont'd)

Standard	Parameter Name	Setting
TELEC-T403 78MHz < 5.6GHz (WLAN)	Spurious Result Type	Worst
	Spurious Fail Stop	Off
	Spurious Segment Switch1	On
	Spurious Segment Switch2	On
	Spurious Segment Switch3	Off
	Segment-1 Start Freq	30 MHz
	Segment-1 Stop Freq	5.42 GHz
	Segment-1 RBW	1 MHz
	Segment-1 VBW	1 MHz
	Segment-1 Sweep Time Switch	Auto
	Segment-1 Detection	Positive
	Segment-1 Limit Start Level	-26 dB
	Segment-1 Limit Stop Level	-26 dB
	Segment-2 Start Freq	5.76 GHz
	Segment-2 Stop Freq	26 GHz or Max Frequency
	Segment-2 RBW	1 MHz
	Segment-2 VBW	1 MHz
	Segment-2 Sweep Time Switch	Auto
	Segment-2 Detection	Positive
	Segment-2 Limit Start Level	-26 dB
Segment-2 Limit Stop Level	-26 dB	

Table C-6 Standard parameters for Spurious Emission (Cont'd)

Standard	Parameter Name	Setting
TELEC-T403 5500MHz-5700M Hz (WLAN)	Spurious Result Type	Worst
	Spurious Fail Stop	Off
	Spurious Segment Switch1	On
	Spurious Segment Switch2	On
	Spurious Segment Switch3	On
	Spurious Segment Switch4	On
	Spurious Segment Switch5	Off
	Segment-1 Start Freq	5.455 GHz
	Segment-1 Stop Freq	5.460 GHz
	Segment-1 RBW	1 MHz
	Segment-1 VBW	1 MHz
	Segment-1 Sweep Time Switch	Auto
	Segment-1 Detection	Positive
	Segment-1 Limit Start Level	-26.02 dB
	Segment-1 Limit Stop Level	-26.02 dB
	Segment-2 Start Freq	5.460 GHz
	Segment-2 Stop Freq	5.470 GHz
	Segment-2 RBW	1 MHz
	Segment-2 VBW	1 MHz
	Segment-2 Sweep Time Switch	Auto
	Segment-2 Detection	Positive
	Segment-2 Limit Start Level	-19.03 dB
	Segment-2 Limit Stop Level	-19.03 dB
	Segment-3 Start Freq	5.725 GHz
	Segment-3 Stop Freq	5.740 GHz
	Segment-3 RBW	1 MHz
	Segment-3 VBW	1 MHz
	Segment-3 Sweep Time Switch	Auto
	Segment-3 Detection	Positive
	Segment-3 Limit Start Level	-19.03 dB
	Segment-3 Limit Stop Level	-19.03 dB
	Segment-4 Start Freq	5.740 GHz
Segment-4 Stop Freq	5.745 GHz	
Segment-4 RBW	1 MHz	
Segment-4 VBW	1 MHz	
Segment-4 Sweep Time Switch	Auto	
Segment-4 Detection	Positive	
Segment-4 Limit Start Level	-26.02 dB	
Segment-4 Limit Stop Level	-26.02 dB	

Table C-6 Standard parameters for Spurious Emission (Cont'd)

Standard	Parameter Name	Setting
TELEC-T403 5510MHz-5670M Hz (WLAN)	Spurious Result Type	Worst
	Spurious Fail Stop	Off
	Spurious Segment Switch1	On
	Spurious Segment Switch2	On
	Spurious Segment Switch3	On
	Spurious Segment Switch4	Off
	Segment-1 Start Freq	5.420 GHz
	Segment-1 Stop Freq	5.460 GHz
	Segment-1 RBW	1 MHz
	Segment-1 VBW	1 MHz
	Segment-1 Sweep Time Switch	Auto
	Segment-1 Detection	Positive
	Segment-1 Limit Start Level	-19.03 dB
	Segment-1 Limit Stop Level	-19.03 dB
	Segment-2 Start Freq	5.460 GHz
	Segment-2 Stop Freq	5.470 GHz
	Segment-2 RBW	1 MHz
	Segment-2 VBW	1 MHz
	Segment-2 Sweep Time Switch	Auto
	Segment-2 Detection	Positive
	Segment-2 Limit Start Level	-13.01 dB
	Segment-2 Limit Stop Level	-13.01 dB
	Segment-3 Start Freq	5.725 GHz
	Segment-3 Stop Freq	5.760 GHz
	Segment-3 RBW	1 MHz
	Segment-3 VBW	1 MHz
	Segment-3 Sweep Time Switch	Auto
	Segment-3 Detection	Positive
Segment-3 Limit Start Level	-19.03 dB	
Segment-3 Limit Stop Level	-19.03 dB	

Table C-6 Standard parameters for Spurious Emission (Cont'd)

Standard	Parameter Name	Setting
TELEC-T403 5530MHz-5610M Hz (WLAN)	Spurious Result Type	Worst
	Spurious Fail Stop	Off
	Spurious Segment Switch1	On
	Spurious Segment Switch2	On
	Spurious Segment Switch3	On
	Spurious Segment Switch4	On
	Spurious Segment Switch5	Off
	Segment-1 Start Freq	5.340 GHz
	Segment-1 Stop Freq	5.460 GHz
	Segment-1 RBW	1 MHz
	Segment-1 VBW	1 MHz
	Segment-1 Sweep Time Switch	Auto
	Segment-1 Detection	Positive
	Segment-1 Limit Start Level	-19.03 dB
	Segment-1 Limit Stop Level	-19.03 dB
	Segment-2 Start Freq	5.4600 GHz
	Segment-2 Stop Freq	5.4695 GHz
	Segment-2 RBW	1 MHz
	Segment-2 VBW	1 MHz
	Segment-2 Sweep Time Switch	Auto
	Segment-2 Detection	Positive
	Segment-2 Limit Start Level	-13.01 dB
	Segment-2 Limit Stop Level	-13.01 dB
	Segment-3 Start Freq	5.4695 GHz
	Segment-3 Stop Freq	5.470 GHz
	Segment-3 RBW	1 MHz
	Segment-3 VBW	1 MHz
	Segment-3 Sweep Time Switch	Auto
	Segment-3 Detection	Positive
	Segment-3 Limit Start Level	-12.91 dB
	Segment-3 Limit Stop Level	-12.91 dB
	Segment-4 Start Freq	5.725 GHz
Segment-4 Stop Freq	5.860 GHz	
Segment-4 RBW	1 MHz	
Segment-4 VBW	1 MHz	
Segment-4 Sweep Time Switch	Auto	
Segment-4 Detection	Positive	
Segment-4 Limit Start Level	-19.03 dB	
Segment-4 Limit Stop Level	-19.03 dB	

Table C-6 Standard parameters for Spurious Emission (Cont'd)

Standard	Parameter Name	Setting
TELEC-T403 5570MHz (WLAN)	Spurious Result Type	Worst
	Spurious Fail Stop	Off
	Spurious Segment Switch1	On
	Spurious Segment Switch2	On
	Spurious Segment Switch3	On
	Spurious Segment Switch4	Off
	Segment-1 Start Freq	5.2360 GHz
	Segment-1 Stop Freq	5.4196 GHz
	Segment-1 RBW	1 MHz
	Segment-1 VBW	1 MHz
	Segment-1 Sweep Time Switch	Auto
	Segment-1 Detection	Positive
	Segment-1 Limit Start Level	-19.03 dB
	Segment-1 Limit Stop Level	-19.03 dB
	Segment-2 Start Freq	5.4196 GHz
	Segment-2 Stop Freq	5.4700 GHz
	Segment-2 RBW	1 MHz
	Segment-2 VBW	1 MHz
	Segment-2 Sweep Time Switch	Auto
	Segment-2 Detection	Positive
	Segment-2 Limit Start Level	-13.01 dB
	Segment-2 Limit Stop Level	-13.01 dB
	Segment-3 Start Freq	5.725 GHz
	Segment-3 Stop Freq	5.904 GHz
	Segment-3 RBW	1 MHz
	Segment-3 VBW	1 MHz
	Segment-3 Sweep Time Switch	Auto
	Segment-3 Detection	Positive
Segment-3 Limit Start Level	-19.03 dB	
Segment-3 Limit Stop Level	-19.03 dB	

TELEC-T405

Table C-6 Standard parameters for Spurious Emission (Cont'd)

Standard	Parameter Name	Setting
TELEC-T405 5MHz 4.9GHz (WLAN)	Spurious Result Type	Worst
	Spurious Fail Stop	Off
	Spurious Segment Switch1	On
	Spurious Segment Switch2	On
	Spurious Segment Switch3	On
	Spurious Segment Switch4	On
	Spurious Segment Switch5	Off
	Segment-1 Start Freq	30 MHz
	Segment-1 Stop Freq	4.87 GHz
	Segment-1 RBW	1 MHz
	Segment-1 VBW	1 MHz
	Segment-1 Sweep Time Switch	Auto
	Segment-1 Detection	Positive
	Segment-1 Limit Start Level	-27 dB
	Segment-1 Limit Stop Level	-27 dB
	Segment-2 Start Freq	4.87 GHz
	Segment-2 Stop Freq	4.9025 GHz
	Segment-2 RBW	1 MHz
	Segment-2 VBW	1 MHz
	Segment-2 Sweep Time Switch	Auto
	Segment-2 Detection	Positive
	Segment-2 Limit Start Level	-26 dB
	Segment-2 Limit Stop Level	-26 dB
	Segment-3 Start Freq	4.9575 GHz
	Segment-3 Stop Freq	5.27 GHz
	Segment-3 RBW	1 MHz
	Segment-3 VBW	1 MHz
	Segment-3 Sweep Time Switch	Auto
	Segment-3 Detection	Positive
	Segment-3 Limit Start Level	-26 dB
	Segment-3 Limit Stop Level	-26 dB
	Segment-4 Start Freq	5.27 GHz
Segment-4 Stop Freq	5.342 GHz	
Segment-4 RBW	1 MHz	
Segment-4 VBW	1 MHz	
Segment-4 Sweep Time Switch	Auto	
Segment-4 Detection	Positive	

Table C-6 Standard parameters for Spurious Emission (Cont'd)

Standard	Parameter Name	Setting
TELEC-T405 5MHz 4.9GHz (WLAN)	Segment-4 Limit Start Level	-37 dB
	Segment-4 Limit Stop Level	-37 dB
	Segment-5 Start Freq	5.342 GHz
	Segment-5 Stop Freq	26 GHz or Max Frequency
	Segment-5 RBW	1 MHz
	Segment-5 VBW	1 MHz
	Segment-5 Sweep Time Switch	Auto
	Segment-5 Detection	Positive
	Segment-5 Limit Start Level	-30 dB
	Segment-5 Limit Stop Level	-30 dB

Table C-6 Standard parameters for Spurious Emission (Cont'd)

Standard	Parameter Name	Setting
TELEC-T405 5MHz 5.0GHz (WLAN)	Spurious Result Type	Worst
	Spurious Fail Stop	Off
	Spurious Segment Switch1	On
	Spurious Segment Switch2	On
	Spurious Segment Switch3	On
	Spurious Segment Switch4	On
	Spurious Segment Switch5	Off
	Segment-1 Start Freq	30 MHz
	Segment-1 Stop Freq	4.99 GHz
	Segment-1 RBW	1 MHz
	Segment-1 VBW	1 MHz
	Segment-1 Sweep Time Switch	Auto
	Segment-1 Detection	Positive
	Segment-1 Limit Start Level	-27 dB
	Segment-1 Limit Stop Level	-27 dB
	Segment-2 Start Freq	4.99 GHz
	Segment-2 Stop Freq	5.0225 GHz
	Segment-2 RBW	1 MHz
	Segment-2 VBW	1 MHz
	Segment-2 Sweep Time Switch	Auto
	Segment-2 Detection	Positive
	Segment-2 Limit Start Level	-26 dB
	Segment-2 Limit Stop Level	-26 dB
	Segment-3 Start Freq	5.0675 GHz
	Segment-3 Stop Freq	5.27 GHz
	Segment-3 RBW	1 MHz
	Segment-3 VBW	1 MHz
	Segment-3 Sweep Time Switch	Auto
	Segment-3 Detection	Positive
	Segment-3 Limit Start Level	-26 dB
	Segment-3 Limit Stop Level	-26 dB
	Segment-4 Start Freq	5.27 GHz
Segment-4 Stop Freq	5.342 GHz	
Segment-4 RBW	1 MHz	
Segment-4 VBW	1 MHz	
Segment-4 Sweep Time Switch	Auto	
Segment-4 Detection	Positive	

Table C-6 Standard parameters for Spurious Emission (Cont'd)

Standard	Parameter Name	Setting
TELEC-T405 5MHz 5.0GHz (WLAN)	Segment-4 Limit Start Level	-37 dB
	Segment-4 Limit Stop Level	-37 dB
	Segment-5 Start Freq	5.342 GHz
	Segment-5 Stop Freq	26 GHz or Max Frequency
	Segment-5 RBW	1 MHz
	Segment-5 VBW	1 MHz
	Segment-5 Sweep Time Switch	Auto
	Segment-5 Detection	Positive
	Segment-5 Limit Start Level	-30 dB
	Segment-5 Limit Stop Level	-30 dB

Table C-6 Standard parameters for Spurious Emission (Cont'd)

Standard	Parameter Name	Setting
TELEC-T405 10MHz 4.9GHz (WLAN)	Spurious Result Type	Worst
	Spurious Fail Stop	Off
	Spurious Segment Switch1	On
	Spurious Segment Switch2	On
	Spurious Segment Switch3	On
	Spurious Segment Switch4	On
	Spurious Segment Switch5	Off
	Segment-1 Start Freq	30 MHz
	Segment-1 Stop Freq	4.87 GHz
	Segment-1 RBW	1 MHz
	Segment-1 VBW	1 MHz
	Segment-1 Sweep Time Switch	Auto
	Segment-1 Detection	Positive
	Segment-1 Limit Start Level	-27 dB
	Segment-1 Limit Stop Level	-27 dB
	Segment-2 Start Freq	4.87 GHz
	Segment-2 Stop Freq	4.895 GHz
	Segment-2 RBW	1 MHz
	Segment-2 VBW	1 MHz
	Segment-2 Sweep Time Switch	Auto
	Segment-2 Detection	Positive
	Segment-2 Limit Start Level	-26 dB
	Segment-2 Limit Stop Level	-26 dB
	Segment-3 Start Freq	4.965 GHz
	Segment-3 Stop Freq	5.27 GHz
	Segment-3 RBW	1 MHz
	Segment-3 VBW	1 MHz
	Segment-3 Sweep Time Switch	Auto
	Segment-3 Detection	Positive
	Segment-3 Limit Start Level	-26 dB
	Segment-3 Limit Stop Level	-26 dB
	Segment-4 Start Freq	5.27 GHz
Segment-4 Stop Freq	5.342 GHz	
Segment-4 RBW	1 MHz	
Segment-4 VBW	1 MHz	
Segment-4 Sweep Time Switch	Auto	
Segment-4 Detection	Positive	

Table C-6 Standard parameters for Spurious Emission (Cont'd)

Standard	Parameter Name	Setting
TELEC-T405 10MHz 4.9GHz (WLAN)	Segment-4 Limit Start Level	-37 dB
	Segment-4 Limit Stop Level	-37 dB
	Segment-5 Start Freq	5.342 GHz
	Segment-5 Stop Freq	26 GHz or Max Frequency
	Segment-5 RBW	1 MHz
	Segment-5 VBW	1 MHz
	Segment-5 Sweep Time Switch	Auto
	Segment-5 Detection	Positive
	Segment-5 Limit Start Level	-30 dB
	Segment-5 Limit Stop Level	-30 dB

Table C-6 Standard parameters for Spurious Emission (Cont'd)

Standard	Parameter Name	Setting
TELEC-T405 10MHz 5.0GHz (WLAN)	Spurious Result Type	Worst
	Spurious Fail Stop	Off
	Spurious Segment Switch1	On
	Spurious Segment Switch2	On
	Spurious Segment Switch3	On
	Spurious Segment Switch4	On
	Spurious Segment Switch5	Off
	Segment-1 Start Freq	30 MHz
	Segment-1 Stop Freq	4.99 GHz
	Segment-1 RBW	1 MHz
	Segment-1 VBW	1 MHz
	Segment-1 Sweep Time Switch	Auto
	Segment-1 Detection	Positive
	Segment-1 Limit Start Level	-27 dB
	Segment-1 Limit Stop Level	-27 dB
	Segment-2 Start Freq	4.99 GHz
	Segment-2 Stop Freq	5.015 GHz
	Segment-2 RBW	1 MHz
	Segment-2 VBW	1 MHz
	Segment-2 Sweep Time Switch	Auto
	Segment-2 Detection	Positive
	Segment-2 Limit Start Level	-26 dB
	Segment-2 Limit Stop Level	-26 dB
	Segment-3 Start Freq	5.075 GHz
	Segment-3 Stop Freq	5.27 GHz
	Segment-3 RBW	1 MHz
	Segment-3 VBW	1 MHz
	Segment-3 Sweep Time Switch	Auto
	Segment-3 Detection	Positive
	Segment-3 Limit Start Level	-26 dB
	Segment-3 Limit Stop Level	-26 dB
	Segment-4 Start Freq	5.27 GHz
Segment-4 Stop Freq	5.342 GHz	
Segment-4 RBW	1 MHz	
Segment-4 VBW	1 MHz	
Segment-4 Sweep Time Switch	Auto	
Segment-4 Detection	Positive	

Table C-6 Standard parameters for Spurious Emission (Cont'd)

Standard	Parameter Name	Setting
TELEC-T405 10MHz 5.0GHz (WLAN)	Segment-4 Limit Start Level	-37 dB
	Segment-4 Limit Stop Level	-37 dB
	Segment-5 Start Freq	5.342 GHz
	Segment-5 Stop Freq	26 GHz or Max Frequency
	Segment-5 RBW	1 MHz
	Segment-5 VBW	1 MHz
	Segment-5 Sweep Time Switch	Auto
	Segment-5 Detection	Positive
	Segment-5 Limit Start Level	-30 dB
	Segment-5 Limit Stop Level	-30 dB

Table C-6 Standard parameters for Spurious Emission (Cont'd)

Standard	Parameter Name	Setting
TELEC-T405 20MHz 4.9GHz OFDM (WLAN)	Spurious Result Type	Worst
	Spurious Fail Stop	Off
	Spurious Segment Switch1	On
	Spurious Segment Switch2	On
	Spurious Segment Switch3	On
	Spurious Segment Switch4	On
	Spurious Segment Switch5	Off
	Segment-1 Start Freq	30 MHz
	Segment-1 Stop Freq	4.87 GHz
	Segment-1 RBW	1 MHz
	Segment-1 VBW	1 MHz
	Segment-1 Sweep Time Switch	Auto
	Segment-1 Detection	Positive
	Segment-1 Limit Start Level	-27 dB
	Segment-1 Limit Stop Level	-27 dB
	Segment-2 Start Freq	4.87 GHz
	Segment-2 Stop Freq	4.875 GHz
	Segment-2 RBW	1 MHz
	Segment-2 VBW	1 MHz
	Segment-2 Sweep Time Switch	Auto
	Segment-2 Detection	Positive
	Segment-2 Limit Start Level	-26 dB
	Segment-2 Limit Stop Level	-26 dB
	Segment-3 Start Freq	5.025 GHz
	Segment-3 Stop Freq	5.27 GHz
	Segment-3 RBW	1 MHz
	Segment-3 VBW	1 MHz
	Segment-3 Sweep Time Switch	Auto
	Segment-3 Detection	Positive
	Segment-3 Limit Start Level	-26 dB
	Segment-3 Limit Stop Level	-26 dB
	Segment-4 Start Freq	5.27 GHz
Segment-4 Stop Freq	5.342 GHz	
Segment-4 RBW	1 MHz	
Segment-4 VBW	1 MHz	
Segment-4 Sweep Time Switch	Auto	
Segment-4 Detection	Positive	

Table C-6 Standard parameters for Spurious Emission (Cont'd)

Standard	Parameter Name	Setting
TELEC-T405 20MHz 4.9GHz OFDM (WLAN)	Segment-4 Limit Start Level	-37 dB
	Segment-4 Limit Stop Level	-37 dB
	Segment-5 Start Freq	5.342 GHz
	Segment-5 Stop Freq	26 GHz or Max Frequency
	Segment-5 RBW	1 MHz
	Segment-5 VBW	1 MHz
	Segment-5 Sweep Time Switch	Auto
	Segment-5 Detection	Positive
	Segment-5 Limit Start Level	-30 dB
	Segment-5 Limit Stop Level	-30 dB

Table C-6 Standard parameters for Spurious Emission (Cont'd)

Standard	Parameter Name	Setting
TELEC-T405 20MHz 4.9GHz DSSS/CCK (WLAN)	Spurious Result Type	Worst
	Spurious Fail Stop	Off
	Spurious Segment Switch1	On
	Spurious Segment Switch2	On
	Spurious Segment Switch3	On
	Spurious Segment Switch4	On
	Spurious Segment Switch5	Off
	Segment-1 Start Freq	30 MHz
	Segment-1 Stop Freq	4.87 GHz
	Segment-1 RBW	1 MHz
	Segment-1 VBW	1 MHz
	Segment-1 Sweep Time Switch	Auto
	Segment-1 Detection	Positive
	Segment-1 Limit Start Level	-27 dB
	Segment-1 Limit Stop Level	-27 dB
	Segment-2 Start Freq	4.87 GHz
	Segment-2 Stop Freq	4.88 GHz
	Segment-2 RBW	1 MHz
	Segment-2 VBW	1 MHz
	Segment-2 Sweep Time Switch	Auto
	Segment-2 Detection	Positive
	Segment-2 Limit Start Level	-26 dB
	Segment-2 Limit Stop Level	-26 dB
	Segment-3 Start Freq	5.020 GHz
	Segment-3 Stop Freq	5.27 GHz
	Segment-3 RBW	1 MHz
	Segment-3 VBW	1 MHz
	Segment-3 Sweep Time Switch	Auto
	Segment-3 Detection	Positive
	Segment-3 Limit Start Level	-26 dB
	Segment-3 Limit Stop Level	-26 dB
	Segment-4 Start Freq	5.27 GHz
Segment-4 Stop Freq	5.342 GHz	
Segment-4 RBW	1 MHz	
Segment-4 VBW	1 MHz	
Segment-4 Sweep Time Switch	Auto	
Segment-4 Detection	Positive	

Table C-6 Standard parameters for Spurious Emission (Cont'd)

Standard	Parameter Name	Setting
TELEC-T405 20MHz 4.9GHz DSSS/CCK (WLAN)	Segment-4 Limit Start Level	-37 dB
	Segment-4 Limit Stop Level	-37 dB
	Segment-5 Start Freq	5.342 GHz
	Segment-5 Stop Freq	26 GHz or Max Frequency
	Segment-5 RBW	1 MHz
	Segment-5 VBW	1 MHz
	Segment-5 Sweep Time Switch	Auto
	Segment-5 Detection	Positive
	Segment-5 Limit Start Level	-30 dB
	Segment-5 Limit Stop Level	-30 dB

Table C-6 Standard parameters for Spurious Emission (Cont'd)

Standard	Parameter Name	Setting
TELEC-T405 20MHz 5.0GHz OFDM (WLAN)	Spurious Result Type	Worst
	Spurious Fail Stop	Off
	Spurious Segment Switch1	On
	Spurious Segment Switch2	On
	Spurious Segment Switch3	On
	Spurious Segment Switch4	On
	Spurious Segment Switch5	Off
	Segment-1 Start Freq	30 MHz
	Segment-1 Stop Freq	4.99 GHz
	Segment-1 RBW	1 MHz
	Segment-1 VBW	1 MHz
	Segment-1 Sweep Time Switch	Auto
	Segment-1 Detection	Positive
	Segment-1 Limit Start Level	-27 dB
	Segment-1 Limit Stop Level	-27 dB
	Segment-2 Start Freq	4.99 GHz
	Segment-2 Stop Freq	4.995 GHz
	Segment-2 RBW	1 MHz
	Segment-2 VBW	1 MHz
	Segment-2 Sweep Time Switch	Auto
	Segment-2 Detection	Positive
	Segment-2 Limit Start Level	-26 dB
	Segment-2 Limit Stop Level	-26 dB
	Segment-3 Start Freq	5.125 GHz
	Segment-3 Stop Freq	5.27 GHz
	Segment-3 RBW	1 MHz
	Segment-3 VBW	1 MHz
	Segment-3 Sweep Time Switch	Auto
	Segment-3 Detection	Positive
	Segment-3 Limit Start Level	-26 dB
	Segment-3 Limit Stop Level	-26 dB
	Segment-4 Start Freq	5.27 GHz
Segment-4 Stop Freq	5.342 GHz	
Segment-4 RBW	1 MHz	
Segment-4 VBW	1 MHz	
Segment-4 Sweep Time Switch	Auto	
Segment-4 Detection	Positive	

Table C-6 Standard parameters for Spurious Emission (Cont'd)

Standard	Parameter Name	Setting
TELEC-T405 20MHz 5.0GHz OFDM (WLAN)	Segment-4 Limit Start Level	-37 dB
	Segment-4 Limit Stop Level	-37 dB
	Segment-5 Start Freq	5.342 GHz
	Segment-5 Stop Freq	26 GHz or Max Frequency
	Segment-5 RBW	1 MHz
	Segment-5 VBW	1 MHz
	Segment-5 Sweep Time Switch	Auto
	Segment-5 Detection	Positive
	Segment-5 Limit Start Level	-30 dB
	Segment-5 Limit Stop Level	-30 dB

Table C-6 Standard parameters for Spurious Emission (Cont'd)

Standard	Parameter Name	Setting
TELEC-T405 20MHz 5.0GHz DSSS/CCK (WLAN)	Spurious Result Type	Worst
	Spurious Fail Stop	Off
	Spurious Segment Switch1	On
	Spurious Segment Switch2	On
	Spurious Segment Switch3	On
	Spurious Segment Switch4	On
	Spurious Segment Switch5	Off
	Segment-1 Start Freq	30 MHz
	Segment-1 Stop Freq	4.99 GHz
	Segment-1 RBW	1 MHz
	Segment-1 VBW	1 MHz
	Segment-1 Sweep Time Switch	Auto
	Segment-1 Detection	Positive
	Segment-1 Limit Start Level	-27 dB
	Segment-1 Limit Stop Level	-27 dB
	Segment-2 Start Freq	4.99 GHz
	Segment-2 Stop Freq	5.00 GHz
	Segment-2 RBW	1 MHz
	Segment-2 VBW	1 MHz
	Segment-2 Sweep Time Switch	Auto
	Segment-2 Detection	Positive
	Segment-2 Limit Start Level	-26 dB
	Segment-2 Limit Stop Level	-26 dB
	Segment-3 Start Freq	5.120 GHz
	Segment-3 Stop Freq	5.27 GHz
	Segment-3 RBW	1 MHz
	Segment-3 VBW	1 MHz
	Segment-3 Sweep Time Switch	Auto
	Segment-3 Detection	Positive
	Segment-3 Limit Start Level	-26 dB
	Segment-3 Limit Stop Level	-26 dB
	Segment-4 Start Freq	5.27 GHz
Segment-4 Stop Freq	5.342 GHz	
Segment-4 RBW	1 MHz	
Segment-4 VBW	1 MHz	
Segment-4 Sweep Time Switch	Auto	
Segment-4 Detection	Positive	

Table C-6 Standard parameters for Spurious Emission (Cont'd)

Standard	Parameter Name	Setting
TELEC-T405 20MHz 5.0GHz DSSS/CCK (WLAN)	Segment-4 Limit Start Level	-37 dB
	Segment-4 Limit Stop Level	-37 dB
	Segment-5 Start Freq	5.342 GHz
	Segment-5 Stop Freq	26 GHz or Max Frequency
	Segment-5 RBW	1 MHz
	Segment-5 VBW	1 MHz
	Segment-5 Sweep Time Switch	Auto
	Segment-5 Detection	Positive
	Segment-5 Limit Start Level	-30 dB
	Segment-5 Limit Stop Level	-30 dB

Table C-6 Standard parameters for Spurious Emission (Cont'd)

Standard	Parameter Name	Setting
TELEC-T405 40MHz (WLAN)	Spurious Result Type	Worst
	Spurious Fail Stop	Off
	Spurious Segment Switch1	On
	Spurious Segment Switch2	On
	Spurious Segment Switch3	On
	Spurious Segment Switch4	Off
	Segment-1 Start Freq	30 MHz
	Segment-1 Stop Freq	4.840 GHz
	Segment-1 RBW	1 MHz
	Segment-1 VBW	1 MHz
	Segment-1 Sweep Time Switch	Auto
	Segment-1 Detection	Positive
	Segment-1 Limit Start Level	-27 dB
	Segment-1 Limit Stop Level	-27 dB
	Segment-2 Start Freq	5.06 GHz
	Segment-2 Stop Freq	5.270 GHz
	Segment-2 RBW	1 MHz
	Segment-2 VBW	1 MHz
	Segment-2 Sweep Time Switch	Auto
	Segment-2 Detection	Positive
	Segment-2 Limit Start Level	-26 dB
	Segment-2 Limit Stop Level	-26 dB
	Segment-3 Start Freq	5.27 GHz
	Segment-3 Stop Freq	5.342 GHz
	Segment-3 RBW	1 MHz
	Segment-3 VBW	1 MHz
	Segment-3 Sweep Time Switch	Auto
	Segment-3 Detection	Positive
	Segment-3 Limit Start Level	-37 dB
	Segment-3 Limit Stop Level	-37 dB
	Segment-4 Start Freq	5.342 GHz
	Segment-4 Stop Freq	26 GHz or Max Frequency
Segment-4 RBW	1 MHz	
Segment-4 VBW	1 MHz	
Segment-4 Sweep Time Switch	Auto	
Segment-4 Detection	Positive	
Segment-4 Limit Start Level	-30 dB	
Segment-4 Limit Stop Level	-30 dB	

FCC 15 407

Table C-6 Standard parameters for Spurious Emission (Cont'd)

Standard	Parameter Name	Setting
FCC 15 407 5.15GHZ (WLAN)	Spurious Result Type	Worst
	Spurious Fail Stop	Off
	Spurious Segment Switch1	On
	Spurious Segment Switch2	On
	Spurious Segment Switch3	Off
	Spurious Segment Switch4	Off
	Spurious Segment Switch5	Off
	Segment-1 Start Freq	30 MHz
	Segment-1 Stop Freq	5.15 GHz
	Segment-1 RBW	1 MHz
	Segment-1 VBW	1 MHz
	Segment-1 Sweep Time Switch	Auto
	Segment-1 Detection	Positive
	Segment-1 Limit Start Level	-27 dB
	Segment-1 Limit Stop Level	-27 dB
	Segment-2 Start Freq	5.25 GHz
	Segment-2 Stop Freq	6.00 GHz or Max Frequency
	Segment-2 RBW	1 MHz
	Segment-2 VBW	1 MHz
	Segment-2 Sweep Time Switch	Auto
	Segment-2 Detection	Positive
	Segment-2 Limit Start Level	-27 dB
Segment-2 Limit Stop Level	-27 dB	

Table C-6 Standard parameters for Spurious Emission (Cont'd)

Standard	Parameter Name	Setting
FCC 15.407 5.25GHZ TX (WLAN)	Spurious Result Type	Worst
	Spurious Fail Stop	Off
	Spurious Segment Switch1	On
	Spurious Segment Switch2	On
	Spurious Segment Switch3	Off
	Spurious Segment Switch4	Off
	Spurious Segment Switch5	Off
	Segment-1 Start Freq	30 MHz
	Segment-1 Stop Freq	5.15 GHz
	Segment-1 RBW	1 MHz
	Segment-1 VBW	1 MHz
	Segment-1 Sweep Time Switch	Auto
	Segment-1 Detection	Positive
	Segment-1 Limit Start Level	-27 dB
	Segment-1 Limit Stop Level	-27 dB
	Segment-2 Start Freq	5.35 GHz
	Segment-2 Stop Freq	6.00 GHz or Max Frequency
	Segment-2 RBW	1 MHz
	Segment-2 VBW	1 MHz
	Segment-2 Sweep Time Switch	Auto
Segment-2 Detection	Positive	
Segment-2 Limit Start Level	-27 dB	
Segment-2 Limit Stop Level	-27 dB	

Table C-6 Standard parameters for Spurious Emission (Cont'd)

Standard	Parameter Name	Setting
FCC 15.407 5.25GHZ DEVICES (WLAN)	Spurious Result Type	Worst
	Spurious Fail Stop	Off
	Spurious Segment Switch1	On
	Spurious Segment Switch2	On
	Spurious Segment Switch3	Off
	Spurious Segment Switch4	Off
	Spurious Segment Switch5	Off
	Segment-1 Start Freq	30 MHz
	Segment-1 Stop Freq	5.15 GHz
	Segment-1 RBW	1 MHz
	Segment-1 VBW	1 MHz
	Segment-1 Sweep Time Switch	Auto
	Segment-1 Detection	Positive
	Segment-1 Limit Start Level	-27 dB
	Segment-1 Limit Stop Level	-27 dB
	Segment-2 Start Freq	5.25 GHz
	Segment-2 Stop Freq	6.00 GHz or Max Frequency
	Segment-2 RBW	1 MHz
	Segment-2 VBW	1 MHz
	Segment-2 Sweep Time Switch	Auto
	Segment-2 Detection	Positive
	Segment-2 Limit Start Level	-27 dB
Segment-2 Limit Stop Level	-27 dB	

Table C-6 Standard parameters for Spurious Emission (Cont'd)

Standard	Parameter Name	Setting
FCC 15.407 5.47GHZ (WLAN)	Spurious Result Type	Worst
	Spurious Fail Stop	Off
	Spurious Segment Switch1	On
	Spurious Segment Switch2	On
	Spurious Segment Switch3	Off
	Spurious Segment Switch4	Off
	Spurious Segment Switch5	Off
	Segment-1 Start Freq	30 MHz
	Segment-1 Stop Freq	5.47 GHz
	Segment-1 RBW	1 MHz
	Segment-1 VBW	1 MHz
	Segment-1 Sweep Time Switch	Auto
	Segment-1 Detection	Positive
	Segment-1 Limit Start Level	-27 dB
	Segment-1 Limit Stop Level	-27 dB
	Segment-2 Start Freq	5.725 GHz
	Segment-2 Stop Freq	6.00 GHz or Max Frequency
	Segment-2 RBW	1 MHz
	Segment-2 VBW	1 MHz
	Segment-2 Sweep Time Switch	Auto
Segment-2 Detection	Positive	
Segment-2 Limit Start Level	-27 dB	
Segment-2 Limit Stop Level	-27 dB	

ETSI EN 301 893

Table C-6 Standard parameters for Spurious Emission (Cont'd)

Standard	Parameter Name	Setting
ETSI EN 301 893 V1.5.1 (WLAN)	Spurious Result Type	Worst
	Spurious Fail Stop	Off
	Spurious Segment Switch1	On
	Spurious Segment Switch2	On
	Spurious Segment Switch3	On
	Spurious Segment Switch4	On
	Spurious Segment Switch5	On
	Spurious Segment Switch6	On
	Spurious Segment Switch7	On
	Spurious Segment Switch8	On
	Spurious Segment Switch9	On
	Spurious Segment Switch10	On
	Spurious Segment Switch11	On
	Spurious Segment Switch12	On
	Spurious Segment Switch13	Off
	Segment-1 Start Freq	30 MHz
	Segment-1 Stop Freq	47 MHz
	Segment-1 RBW	100 kHz
	Segment-1 VBW	100 kHz
	Segment-1 Sweep Time Switch	Auto
	Segment-1 Detection	Positive
	Segment-1 Limit Start Level	-36 dB
	Segment-1 Limit Stop Level	-36 dB
	Segment-2 Start Freq	47 MHz
	Segment-2 Stop Freq	74 MHz
	Segment-2 RBW	100 kHz
	Segment-2 VBW	100 kHz
	Segment-2 Sweep Time Switch	Auto
	Segment-2 Detection	Positive
	Segment-2 Limit Start Level	-54 dB
Segment-2 Limit Stop Level	-54 dB	

Appendix

Appendix C

Table C-6 Standard parameters for Spurious Emission (Cont'd)

Standard	Parameter Name	Setting
ETSI EN 301 893 V1.5.1 (WLAN)	Segment-3 Start Freq	74 MHz
	Segment-3 Stop Freq	87.5 MHz
	Segment-3 RBW	100 kHz
	Segment-3 VBW	100 kHz
	Segment-3 Sweep Time Switch	Auto
	Segment-3 Detection	Positive
	Segment-3 Limit Start Level	-36 dB
	Segment-3 Limit Stop Level	-36 dB
	Segment-4 Start Freq	87.5 MHz
	Segment-4 Stop Freq	118 MHz
	Segment-4 RBW	100 kHz
	Segment-4 VBW	100 kHz
	Segment-4 Sweep Time Switch	Auto
	Segment-4 Detection	Positive
	Segment-4 Limit Start Level	-54 dB
	Segment-4 Limit Stop Level	-54 dB
	Segment-5 Start Freq	118 MHz
	Segment-5 Stop Freq	174 MHz
	Segment-5 RBW	100 kHz
	Segment-5 VBW	100 kHz
	Segment-5 Sweep Time Switch	Auto
	Segment-5 Detection	Positive
	Segment-5 Limit Start Level	-36 dB
	Segment-5 Limit Stop Level	-36 dB
Segment-6 Start Freq	174 MHz	
Segment-6 Stop Freq	230 MHz	
Segment-6 RBW	100 kHz	
Segment-6 VBW	100 kHz	
Segment-6 Sweep Time Switch	Auto	
Segment-6 Detection	Positive	
Segment-6 Limit Start Level	-54 dB	
Segment-6 Limit Stop Level	-54 dB	

Table C-6 Standard parameters for Spurious Emission (Cont'd)

Standard	Parameter Name	Setting
ETSI EN 301 893 V1.5.1 (WLAN)	Segment-7 Start Freq	2300 MHz
	Segment-7 Stop Freq	4700 MHz
	Segment-7 RBW	100 kHz
	Segment-7 VBW	100 kHz
	Segment-7 Sweep Time Switch	Auto
	Segment-7 Detection	Positive
	Segment-7 Limit Start Level	-36 dB
	Segment-7 Limit Stop Level	-36 dB
	Segment-8 Start Freq	470 MHz
	Segment-8 Stop Freq	862 MHz
	Segment-8 RBW	100 kHz
	Segment-8 VBW	100 kHz
	Segment-8 Sweep Time Switch	Auto
	Segment-8 Detection	Positive
	Segment-8 Limit Start Level	-54 dB
	Segment-8 Limit Stop Level	-54 dB
	Segment-9 Start Freq	862 MHz
	Segment-9 Stop Freq	1.0 GHz
	Segment-9 RBW	100 kHz
	Segment-9 VBW	100 kHz
	Segment-9 Sweep Time Switch	Auto
	Segment-9 Detection	Positive
	Segment-9 Limit Start Level	-36 dB
	Segment-9 Limit Stop Level	-36 dB
	Segment-10 Start Freq	1.0 GHz
	Segment-10 Stop Freq	5.15 GHz
	Segment-10 RBW	1 MHz
	Segment-10 VBW	1 MHz
Segment-10 Sweep Time Switch	Auto	
Segment-10 Detection	Positive	
Segment-10 Limit Start Level	-30 dB	
Segment-10 Limit Stop Level	-30 dB	

Table C-6 Standard parameters for Spurious Emission (Cont'd)

Standard	Parameter Name	Setting
ETSI EN 301 893 V1.5.1 (WLAN)	Segment-11 Start Freq	5.35 GHz
	Segment-11 Stop Freq	5.47 GHz
	Segment-11 RBW	1 MHz
	Segment-11 VBW	1 MHz
	Segment-11 Sweep Time Switch	Auto
	Segment-11 Detection	Positive
	Segment-11 Limit Start Level	-30 dB
	Segment-11 Limit Stop Level	-30 dB
	Segment-12 Start Freq	5.75 GHz
	Segment-12 Stop Freq	Max Frequency
	Segment-12 RBW	1 MHz
	Segment-12 VBW	1 MHz
	Segment-12 Sweep Time Switch	Auto
	Segment-12 Detection	Positive
	Segment-12 Limit Start Level	-30 dB
Segment-12 Limit Stop Level	-30 dB	

ETSI 300 328

Table C-6 Standard parameters for Spurious Emission (Cont'd)

Standard	Parameter Name	Setting
ETSI 300 328 V1.7.1 (WLAN)	Spurious Result Type	Worst
	Spurious Fail Stop	Off
	Spurious Segment Switch1	On
	Spurious Segment Switch2	On
	Spurious Segment Switch3	On
	Spurious Segment Switch4	On
	Spurious Segment Switch5	On
	Spurious Segment Switch6	On
	Spurious Segment Switch7	On
	Spurious Segment Switch8	On
	Spurious Segment Switch9	On
	Spurious Segment Switch10	On
	Spurious Segment Switch11	On
	Spurious Segment Switch12	On
	Spurious Segment Switch13	Off
	Segment-1 Start Freq	30 MHz
	Segment-1 Stop Freq	1 GHz
	Segment-1 RBW	100 kHz
	Segment-1 VBW	30 kHz
	Segment-1 Sweep Time Switch	Auto
	Segment-1 Detection	Positive
	Segment-1 Limit Start Level	-36 dB
	Segment-1 Limit Stop Level	-36 dB
	Segment-2 Start Freq	1 GHz
	Segment-2 Stop Freq	1.8 GHz
	Segment-2 RBW	100 kHz
	Segment-2 VBW	30 kHz
	Segment-2 Sweep Time Switch	Auto
	Segment-2 Detection	Positive
	Segment-2 Limit Start Level	-30 dB
Segment-2 Limit Stop Level	-30 dB	

Appendix

Appendix C

Table C-6 Standard parameters for Spurious Emission (Cont'd)

Standard	Parameter Name	Setting
ETSI 300 328 V1.7.1 (WLAN)	Segment-3 Start Freq	1.8 GHz
	Segment-3 Stop Freq	1.9 GHz
	Segment-3 RBW	100 kHz
	Segment-3 VBW	30 kHz
	Segment-3 Sweep Time Switch	Auto
	Segment-3 Detection	Positive
	Segment-3 Limit Start Level	-47 dB
	Segment-3 Limit Stop Level	-47 dB
	Segment-4 Start Freq	5.15 GHz
	Segment-4 Stop Freq	5.3 GHz
	Segment-4 RBW	100 kHz
	Segment-4 VBW	30 kHz
	Segment-4 Sweep Time Switch	Auto
	Segment-4 Detection	Positive
	Segment-4 Limit Start Level	-47 dB
	Segment-4 Limit Stop Level	-47 dB
	Segment-5 Start Freq	5.3 GHz
	Segment-5 Stop Freq	6.00 GHz or 12.75 GHz
	Segment-5 RBW	100 kHz
	Segment-5 VBW	30 kHz
Segment-5 Sweep Time Switch	Auto	
Segment-5 Detection	Positive	
Segment-5 Limit Start Level	-30 dB	
Segment-5 Limit Stop Level	-30 dB	

References are to section numbers.

A

ACP	7.1, 7.2
ACP Reference	7.2
Add Point	3.2.4
Accessory	2.1, 6.1, 8.1
Active Trace	3.1, 3.1.2, 3.1.3
Adjacent Channel Leakage Power	7.1, 7.2
Amplitude	2.1, 2.4, 3.2.4
Attenuator	2.4, 2.4.2
Auto Sweep Time Select	3.3
Average	3.1

B

BBIF trigger	5.1.1, 5.2.1
Burst Average Power	7.1, 7.3
BW	2.1, 2.5

C

Center	2.3
Ch BW	7.2
Channel Power	7.1, 7.4
Connected to Previous Pt	3.2.4
Continuous	2.2
Couple Time/Frequency Domain	2.3.7
Create Envelope	3.2.5

D

Delete All Limits	3.2.2
Delete Limit	3.2.3
Delete Point	3.2.4
Delta	4.1
Detection	2.5.2, 3.1
Detection mode	2.5.2, 3.1.4, 4.3.1

E

Edit	3.2.3
Envelope	3.2.3
Envelope Point	3.2.5
Erase Warm Up Message	8.1
Event Type	3.4.1

Extension of Preselector Lower

Limit to 3 GHz	2.3.6
External	5.1.1, 5.2.1
External trigger	5.1.1, 5.2.1

F

Filter	7.2, 7.4
Filter Type	7.2
Freq. Count	4.1.8
Frequency	2.1, 2.3, 3.2.4
Frequency Band Mode	2.3
Frequency domain mode	2.3.2
Frequency span	2.1, 2.3, 2.3.2
Full Span	2.3

G

Gate	2.1, 5.1, 5.2
Gate Delay	5.1
Gate Length	5.1
Gate Level	5.1
Gate Slope	5.1
Gate Source	5.1
Gate Sweep	5.1, 5.2.1
Gate Time	4.1.8
Gate View	5.2.2

I

In Band Ch BW	7.2
Internal Reference Frequency Signal	8.5

L

Limit Test	3.2, 3.2.2
Limit Line	3.2
Limit1	3.2.2
Limit2	3.2.2
Limit (Amplitude)	3.2.2
Limit Display	3.2.3
Level	2.1, 2.4
Level display unit	2.4.4
Lin Average	3.1.1
Lin Scale Division	2.4.3
Lin scale	2.4.3
Load Standard Parameter	7.2, 7.3, 7.4, 7.5
Log Scale Division	2.4.3
Log Scale Line	2.4.3
Log Scale Unit	2.4, 2.4.4

Index

Log scale	2.4.3	Recall Limit x	3.2.3
M		Ref. Ext	8.6
Margin	3.2.3	Ref. Ext	8.6
Margin Value	3.2.3	Ref. Ext Unlock	8.6
Marker	2.1, 4.1, 4.3	Reference Frequency Signal	8.6
Marker tracking	4.1, 4.2.9	Ref. Int	8.6
Marker to Center Freq.	4.1, 4.2, 4.2.5	Ref. Int Unlock	8.6
Marker to Ref. Level	4.1, 4.2, 4.2.5	Reference Clock	8.1, 8.5
Max Hold	3.1.1, 3.1.3	Reference Clock Preset	8.5
Measure	2.1, 7.1	Reference Level	2.4, 2.4.1
Measure function	2.1, 7.1	Resolution	4.2
Mirror Limit	3.2.3	Resolution bandwidth	2.1, 2.5, 2.5.1
Min Hold	3.1.1, 3.1.3	RMS	3.1.4
N		Roll-off factor	7.2
Negative	3.1.4	S	
Next Peak	4.2	SG Marker	5.1.1, 5.2.1
Next Peak search	4.2, 4.2.2	SG marker trigger	5.1.1, 5.2.1
Normal	4.1	Sample	3.1.4
O		Save Limit	3.2.5
Offset	2.3, 2.4, 7.2	Save Limit x	3.2.3
Offset Value	2.3, 2.4	Save on Event	2.1, 3.4.1
Occupied Bandwidth	7.1, 7.5	Save then Stop	3.4.1
P		Scale	2.4, 2.4.3
Peak Search	2.1, 4.2, 4.2.1	Shape	3.2.5
Peaking bias	6.1	Single	2.2
Point	3.2.4	Span	2.1, 2.3
Pos&Neg	3.1.4	Spectrum Emission Mask	7.6
Positive	3.1.4	Spurious Emission	7.7
Power Marker	Appendix A	Standard	7.1
Power VBW	2.5.3	Standard parameters for ACP function	C-1
Pre-amp	2.4.6	Standard parameters for Burst Average Power	C-2
Preselector	6.1, 8.1	Standard parameters for Channel Power function	C-3
Preselector Auto Tune	2.3, 6.1	Standard parameters for OBW function	C-4
Preselector Tune Preset	6.1	Standard parameters for Spectrum Emission Mask	C-5
Preselector tuning	6.1	Standard parameters for Spurious Emission	C-6
Previous Pt Level Offset	3.2.4	Start	2.3
R		Start Time	7.3
RBW	2.5, 2.5.1	Step Size	2.3
		Stop	2.3

Stop Time	7.3	Z	
Storage Count	3.1	Zero Span	2.3
Storage Mode	3.1	Zone Center Frequency	4.1.3
Sweep Time	2.1, 3.3, 3.3.1	Zone Width	4.1, Appendix B
Sweep type spectrum analyzers			
	1.1		
T			
Test Trace	3.2.3		
Threshold	4.2		
Threshold Level	4.2		
Time domain mode	2.3.2		
Time/Sweep	2.1, 3.2		
Title	8.1		
Trace	2.1, 3.1		
Trace Points	3.3		
Trace Type	3.1		
Trace point	2.1, 3.3.2		
Trigger	2.1, 5.1		
Trigger Delay	5.1		
Trigger Level	5.1		
Trigger Slope	5.1		
Trigger Source	5.1		
Trigger Switch	5.1		
Trigger/Gate	2.1, 5.1		
U			
Uncal Message	8.1		
Update Envelope Amplitude	3.2.5		
V			
VBW	2.5, 2.5.2		
VBW Mode	2.5		
Video	5.1.1		
Video bandwidth	2.1, 2.5, 2.5.2		
Video VBW	2.5.3		
Video trigger	5.1.1		
W			
Warm Up	8.3		
Wide IF Video	5.1.1, 5.2.1		
Wide IF video trigger	5.1.1, 5.2.1		
